

MOTION CONTROL DRIVES

## SINAMICS Converters for Single-Axis Drives

### SINAMICS G120X infrastructure converters for HVAC/Water/Wastewater

[siemens.com/sinamics-g120x](https://www.siemens.com/sinamics-g120x)

Catalog  
D 31.5















Edition  
July  
2024

 SINAMICS G120X

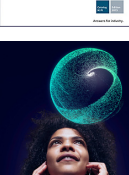

## Related catalogs

<p><b>Motion Control Drives</b> D 31.1 SINAMICS Converters for Single-Axis Drives Built-In Units</p> <p>PDF (E86060-K5531-A111-A4-7600)</p>		<p><b>Motion Control System</b> PM 21 SIMOTION Equipment for Production Machines</p> <p>E86060-K4921-A101-A4-7600</p>	
<p><b>Motion Control Drives</b> D 31.2 SINAMICS Converters for Single-Axis Drives Distributed Converters</p> <p>PDF (E86060-K5531-A121-A3-7600)</p>		<p><b>Industrial Controls</b> IC 10 SIRIUS</p> <p>PDF (E86060-K1010-A101-B5-7600)</p>	
<p><b>Motion Control Drives</b> D 32 SINAMICS S210 Servo Drive System</p> <p>PDF (E86060-K5532-A101-A9-7600)</p>		<p><b>Low-Voltage Power Distribution and Electrical Installation Technology</b> LV 10 SENTRON • SIVACON • ALPHA</p> <p>PDF (E86060-K8280-A101-B8-7600)</p>	
<p><b>SINAMICS S120</b> D 21.3 Chassis Format Converter Units Chassis-2 Format Converter Units Cabinet Modules, Cabinet Modules-2</p> <p><b>SINAMICS S150</b> Converter Cabinet Units PDF (E86060-K5521-A131-A9-7600)</p>		<p><b>SIMATIC</b> ST 70 Products for Totally Integrated Automation</p> <p>PDF (E86060-K4670-A101-C0-7600)</p>	
<p><b>Motion Control Drives</b> D 21.4 SINAMICS S120, SINAMICS S220 and SIMOTICS</p> <p>E86060-K5521-A141-A2-7600</p>		<p><b>SIMATIC HMI / PC-based Automation</b> ST 80/ST PC Human Machine Interface Systems PC-based Automation</p> <p>PDF (E86060-K4680-A101-D1-7600)</p>	
<p><b>Motion Control Drives</b> D 36.1 SINAMICS G220 built-in and wall-mounted units</p> <p>PDF (E86060-K5536-A111-A2-7600)</p>		<p><b>Industrial Communication</b> IK PI SIMATIC NET</p> <p>E86060-K6710-A101-B8-7600</p>	
<p><b>Motion Control Drives</b> D 37.1 SINAMICS S200 Servo drive system</p> <p>PDF (E86060-K5537-A111-A2-7600)</p>		<p><b>SITRAIN</b> Digital Industry Academy</p> <p><a href="http://www.siemens.com/sitrain">www.siemens.com/sitrain</a></p>	
<p><b>SIMOTICS S-1FG1 Servo geared motors</b> D 41 Helical, Parallel shaft, Bevel and Helical worm geared motors</p> <p>PDF (E86060-K5541-A101-A6-7600)</p>		<p><b>SiePortal</b> Information and Ordering Platform on the Internet:</p> <p><a href="http://sieportal.siemens.com">sieportal.siemens.com</a></p>	





Combining the real and digital worlds ...  
Transformation

Catalog  
D 31.5

Edition  
July 2024

## MOTION CONTROL DRIVES

# SINAMICS Converters for Single-Axis Drives

## SINAMICS G120X infrastructure converters for HVAC/Water/Wastewater

[siemens.com/d31-5](https://www.siemens.com/d31-5)

Dear Customer,

We are happy to present you with the new PDF version of the catalog D 31.5 · July 2024.

The catalog provides a comprehensive overview of the SINAMICS G120X converter system for HVAC, water and wastewater applications in the infrastructure sector. With an available power range from 0.75 kW to 630 kW (1 hp to 700 hp), the series masters every challenge here. The new edition of the catalog mainly contains updates and technical adjustments.

The products listed in this catalog are also included in SiePortal. Please contact your local Siemens office for additional information.

Up-to-date information about SINAMICS G120X is available online at [www.siemens.com/sinamics-g120x](https://www.siemens.com/sinamics-g120x)

You can access SiePortal on the internet at <https://sieportal.siemens.com>

Your personal contact will be glad to receive your suggestions and recommendations for improvement. You can find your representative in our personal contacts database at [www.siemens.com/automation-contact](https://www.siemens.com/automation-contact)

We hope that you will often enjoy using Catalog D 31.5 · July 2024 as a selection and ordering reference document and wish you every success with our products and solutions.

With kind regards

A handwritten signature in blue ink, appearing to read 'Frank Golüke', is positioned above the printed name and title.

Frank Golüke  
Vice President  
General Motion Control  
Siemens AG, Digital Industries, Motion Control







# SINAMICS Converters for Single-Axis Drives

## SINAMICS G120X infrastructure converters for HVAC/Water/Wastewater

### Motion Control Drives



### Catalog D 31.5 · July 2024

Supersedes:  
Catalog D 31.5 · May 2022

Refer to SiePortal for current updates of this catalog:  
<https://sieportal.siemens.com>

Please contact your local Siemens branch.

© Siemens 2024

Click on an Article No. in the catalog PDF to call it up in SiePortal and to obtain all the information.

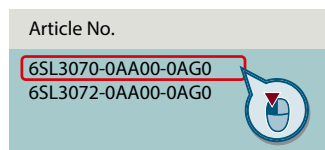

Or directly on the internet, e.g.  
[www.siemens.com/product\\_catalog\\_DIMC?6SL3070-0AA00-0AG0](http://www.siemens.com/product_catalog_DIMC?6SL3070-0AA00-0AG0)



The products and systems described in this catalog are manufactured/distributed under application of a certified quality management system in accordance with EN ISO 9001. The certificate is recognized by all IQNet countries.

### System overview

1

### SINAMICS G120X infrastructure converters for HVAC/Water/Wastewater

2

### Engineering tools

3

### Services and documentation

4

### Appendix

5





# Motion beyond expectations

Drives move the industries. But how can they make them more efficient, more reliable and more sustainable – and exceed all expectations while they are doing it? Our answer: Siemens Xcelerator for Digital Drivetrain.

## Digital solutions for Drivetrain Design and Drivetrain Health

Combine the real and the digital world to reach the next level of efficiency and sustainability in your drivetrain value chain: with suitable digital solutions for drivetrain design and drivetrain health.

### Drivetrain Design:

Simplify and shorten the engineering steps to get faster and more efficiently from concept to the commissioned drivetrain.

### Drivetrain Health:

Reduce total cost of ownership for your equipment and machine park – energy, maintenance, downtime.

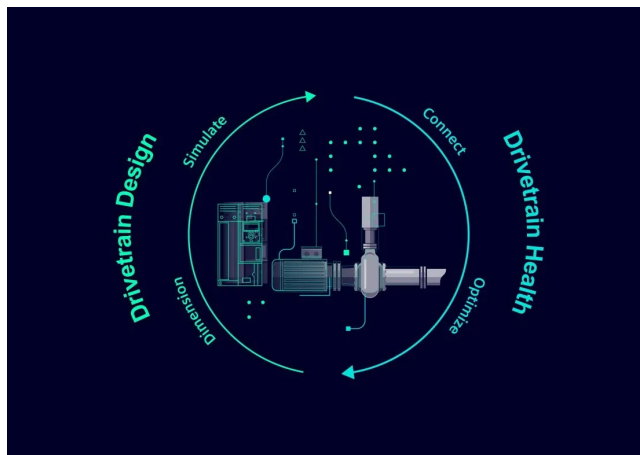

[siemens.com/digital-drivetrain](https://www.siemens.com/digital-drivetrain)

## Digitalization along the drivetrain value chain



### Dimension

Accurate in motion: Dimension your motors, gearboxes, and complete drivetrains digitally with greater precision – for greater reliability and energy efficiency.



### Simulate

Faster in motion: Add the digital twin of the drivetrain to your machine simulation to speed up your design and engineering phases and to accelerate your time-to-market!

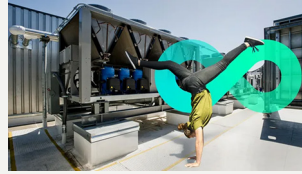

### Connect

Data in motion: Acquire high-quality raw data and connect your entire drivetrains or machines to cloud or on-premise platforms – for a consistent and secure data flow.



### Optimize

Better in motion: Analyze and visualize drivetrain and machine data in digital solutions and apps to identify optimization potentials and concrete actionable measures how to tap it.

## Use cases for digital drivetrain technology



### Condition monitoring for drivetrains

Healthy in motion: Gain valuable insights into your drivetrain to optimize maintenance, system availability, cost efficiency, and sustainability: Discover intelligent digital condition monitoring for your drivetrains!

## Are your drivetrains fit enough for tough times?

The industries are expected to produce ever more efficiently, ever more sustainably and ever more cost-effectively. And if you can't do that, it's easier to be left behind by the competition. Use digitalization and the data from your motors and converters to optimize your competitiveness – and to keep your production in motion.



### What if you consume too much electricity?

With digital solutions and digital drive technology, you can significantly reduce your share of this!



### What if you waste too much energy?

Digitalization enables you to detect energy waste and impending system downtimes at an early stage so that you can take counter-measures in due time!



### What if your motors are incorrectly designed?

Digital tools make it quicker and easier to correctly design your drive components!



### What if your drives fail unexpectedly?

With digital solutions, you can identify risks in your drivetrain at an early stage and react before a failure occurs.

"Our digital solutions transform your drivetrain value chain to the next level of efficiency and sustainability."





# SINAMICS frequency converters

SINAMICS frequency converters – the ultimate solution for all drive applications. From low voltage to medium voltage to direct current (DC), our frequency converters meet your needs. With increased efficiency and versatility, take your applications to the next generation for a digital and sustainable future.

## Driving next generation applications

When it comes to driving industry advancements, look no further than our SINAMICS frequency converters. They fuel the creation of innovative, next-generation applications that meet the unique needs of every industry.

From pumping and ventilating to moving, positioning, processing, and machining, our converters have you covered. Get ready to take your applications to new heights.





### Low voltage converters

Low voltage frequency converters are suitable for a huge range of applications. For example, if materials must be moved, processed, positioned, pumped or compressed. Variable-speed operation saves energy and also increases process quality and process availability.



### Servo converters

These servo converters meet the highest dynamic requirements for single and multi-axis applications. The perfect solution for machine tools, packaging machines, continuous material handling, cranes, rolling mills, test stands, material handling, robotics and many other applications requiring high-precision, dynamic motion control.



### DC converters

The dynamic performance, ruggedness, and cost-effectiveness of DC technology continue to make it the most cost-effective and proven drive solution for many applications today – with numerous advantages in terms of reliability, ease of use, and operational performance.



### Accelerating the digital and sustainable transformation of industry

How can you make production more efficient? Accelerate your digital transformation? And become more sustainable?

The answer is our SINAMICS frequency converters. They are energy efficient, offer the versatility you need for any application, and drive your digital transformation by providing the data to continuously improve production efficiency and sustainability. Our converters offer you integrated safety and security features, efficient engineering and software tools as well as comprehensive lifecycle services. In other words: Everything you need to address the next generation of applications – today and tomorrow.

## EFFICIENT

Implement energy-efficient applications easily, quickly, and safely with efficient motion control.

- Sustainable drive systems
- Efficient Motion Control solutions
- Drive System Services

## VERSATILE

Drives equipped with tailored safety features to ensure optimal machine safety in a wide range of industrial applications.

- Safety and Security Integrated
- Drive applications
- Drives for any industry

## FUTURE-PROOF

Efficient engineering, powerful software tools, and cloud and edge connectivity for greater transparency.

- Digitalization in drive technology
- Efficient drive engineering
- Drive Software for all applications

# Totally Integrated Automation



Totally Integrated Automation (TIA) offers smart automation development, flexible machine concepts, transparent operation, and sustainable solutions that enable access to data to calculate and optimize the product carbon footprint. We are constantly improving and expanding TIA to be future-proof and adaptive to existing and upcoming challenges.

## A comprehensive portfolio for the challenges of today and tomorrow

The TIA offering is integrated seamlessly and it's so comprehensive that it provides the right automation solutions for every industry. We will continue to improve and expand our proven automation portfolio and are constantly including innovative technologies and solutions that pave the way towards the factory of the future.

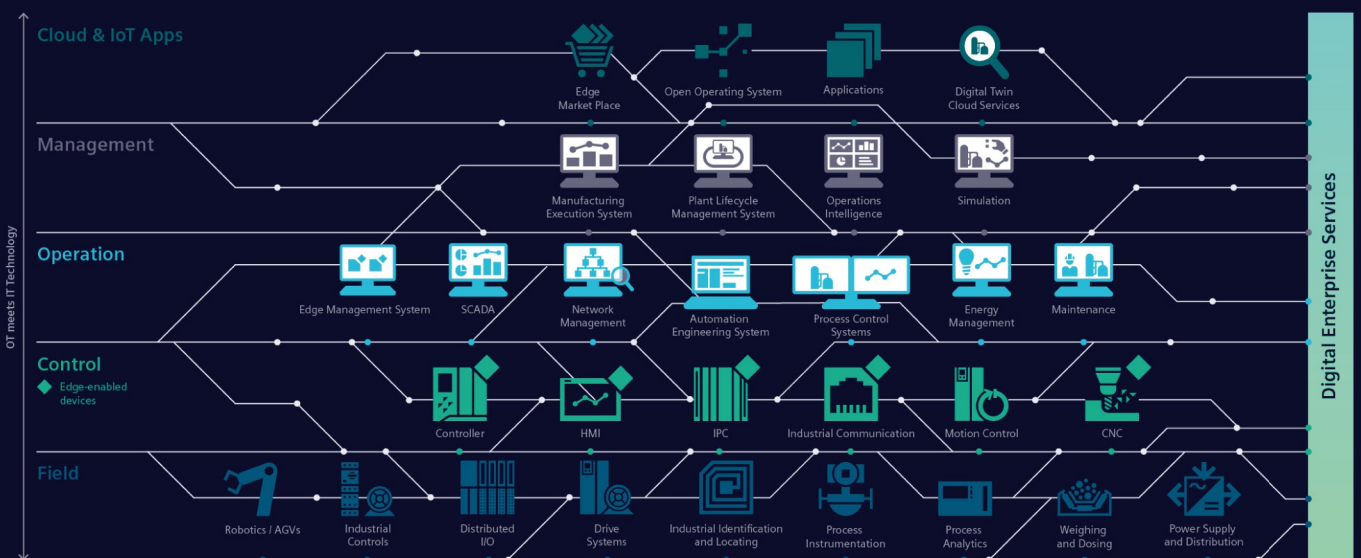

# Real added value for the automation of your production

From the development of innovative machine concepts to engineering and optimized production:

TIA offers real added value along the entire value chain.

## Smart Automation Development

Innovative machine concepts made easy: When you use standardized library concepts and preconfigured expertise, you can count on efficient engineering. Thanks to the integration of safety features, diagnostic functions, and cybersecurity, you also save valuable time.

## Flexible Machine Concepts

No matter what new requirements emerge in the market, TIA supports modular machine concepts and the simple integration of new machines into existing lines – thanks to standardized hardware interfaces and engineering libraries. As a machine builder, this enables you to meet any challenge quickly and reliably.

## Transparent Operation

Integrated interfaces let you achieve a new level of transparency for the essential performance indicators in your processes and plants. The connection between IT and OT along with efficient data management lay the foundation for new service models such as predictive maintenance.

## Future-proof of Automation

Our TIA portfolio is constantly being refined with a view to integrating automation technologies more and more efficiently. The components can then interact with modern IT capabilities, which are becoming increasingly important for specific applications in automation. TIA provides a solid foundation, whether for working with our Industrial Operations X portfolio or for everything the future has in store.

## Sustainable Solutions

Sustainability starts with the acquisition of data. With the TIA portfolio, you can measure energy and resource data and make it transparent, providing a solid foundation for calculating the Product Carbon Footprint. This is crucial for drawing the right conclusions and responding to sudden changes in order to lastingly reduce CO<sub>2</sub> emissions and save more resources in production.

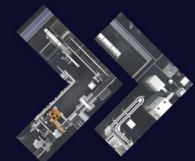

[www.siemens.com/tia](http://www.siemens.com/tia)





# TIA Selection Tool – quick, easy, smart configuration

For you to get the most out of our portfolio quickly and easily.

Do you always need the optimum configuration for planning your project?

For your application we offer the TIA Selection Tool to support all project planners, beginners and experts alike.

No detailed portfolio knowledge is necessary.

TIA Selection Tool is available for download as a free desktop version or a cloud variant.

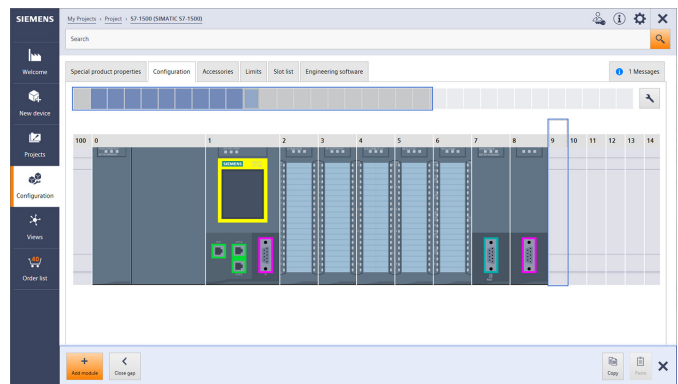

## Your Advantages

### Quick

- Configure a complete project with just a few entries – without a manual, without special knowledge
- Import and export of hardware configuration to TIA Portal or other systems
- Ideal visualization of the projects to be configured

### Easy

- Tool download either as desktop version or web-based cloud version
- Technically always up-to-date about product portfolio and innovative approaches
- Highly flexible, secure, cross-team work in the cloud
- Direct ordering in SiePortal

### Smart

- Smart selection wizard for error-free configuration and ordering
- Configuration options can be tested and simulated in advance
- Library for archiving sample configurations

The TIA Selection Tool is a completely paperless solution.

Download it now:

[www.siemens.com/tst](http://www.siemens.com/tst)

For more  
information,  
scan the  
QR code





# Sustainability @Siemens

Transforming the everyday to create a better tomorrow.



For more information, see [www.siemens.com/sustainability-figures](http://www.siemens.com/sustainability-figures)

As a company, Siemens considers environmental, social and governance (ESG) criteria from all angles with its DEGREE framework (decarbonization, ethics, governance, resource efficiency, equity and employability). We are not only committed to reducing the carbon footprint in our own operations to net zero by 2030, but also helping our customers achieve their decarbonization and sustainability goals.

## Mission & strategy

As a focused technology company, Siemens is committed to addressing the world's most profound challenges by leveraging the synergies between digitalization and sustainability.

## Technology with aim and purpose

We develop technologies that connect the real and digital worlds and enable our customers to positively transform the industries that form the backbone of our economy: industry, infrastructure, transportation and healthcare.

## Our contribution

Siemens makes an impact every day by providing innovative solutions in response to challenges relating to environmental protection, decarbonization, health and safety. Innovative solutions that have a clear goal: to make the world more sustainable, more integrative and a better place to live.

## Sustainability facts

For almost 175 years, Siemens has been driven by the desire to improve the lives of people around the world with our technologies.





## System overview



1/2	<b>The SINAMICS converter family</b>
1/3	<b>Drive selection</b>
1/4	<b>SIMOTICS motors</b>
1/5	<b>Energy efficiency classes in accordance with IEC 61800-9-2</b>
1/8	<b>SINAMICS G120X infrastructure converters for HVAC/Water/Wastewater</b>
1/10	<b>SINAMICS G120X Starter Kits</b>

Further information about SINAMICS and SIMOTICS can be found on the internet at [www.siemens.com/sinamics](http://www.siemens.com/sinamics) and [www.siemens.com/simotics](http://www.siemens.com/simotics)

# System overview

1

## Overview

### SINAMICS frequency converters

SINAMICS frequency converters are the ultimate solution for all drive applications. From low voltage to medium voltage to direct current (DC), our frequency converters meet your needs.

With increased efficiency and versatility, take your drive applications to the next generation for a digital and sustainable future. [www.siemens.com/sinamics](http://www.siemens.com/sinamics)

Low voltage											Direct voltage
Standard performance frequency converters		Distributed frequency converters	Industry-specific frequency converters		Servo converters			High performance frequency converters			DC converters
SINAMICS V20 G120C G120	SINAMICS G130 G150	SINAMICS G115D G120D SIMATIC ET 200pro FC-2	SINAMICS G120X	SINAMICS G180	SINAMICS V90 S200	SINAMICS S110	SINAMICS S210 S210 (New)	SINAMICS G220	SINAMICS S120 S120M	SINAMICS S150	SINAMICS DCM DCP <sup>1)</sup>
0.12 kW to 250 kW	75 kW to 2700 kW	0.37 kW to 7.5 kW	0.75 kW to 630 kW	2.2 kW to 6600 kW	0.05 kW to 7 kW	0.55 kW to 132 kW	0.05 kW to 7 kW	0.55 kW to 55 kW	0.55 kW to 5700 kW	75 kW to 1200 kW	6 kW to 30 MW
Pumps, fans, compressors, conveyor belts, mixers, mills, spinning machines, textile machines, refrigerated display counters, fitness equipment, ventilation systems, single-axis positioning applications in machine and plant engineering	Pumps, fans, compressors, conveyor belts, mixers, mills, extruders	Conveyor technology, single-axis positioning applications (G120D)	Pumps, fans, compressors, building management systems, process industry, HVAC, water/waste water industries	Pumps, fans, compressors, conveyor belts, extruders, mixers, mills, kneaders, centrifuges, separators	Handling machines, packaging machines, automatic assembly machines, metal forming machines, printing machines, winding and unwinding units	Single-axis positioning applications in machine and plant engineering	Packaging machines, handling equipment, feed and withdrawal devices, stacking units, automatic assembly machines, laboratory automation, wood, glass and ceramics industry, digital printing machines	Pumps, fans, compressors, conveyor belts, mixers, mills, spinning machines, textile machines, refrigerated display counters, fitness equipment, ventilation systems, single-axis positioning applications in machine and plant engineering	Production machines (packaging, textile and printing machines, paper machines, plastic processing machines), machine tools, plants, process lines and rolling mills, marine drives, test bays	Test bays, cross cutters, centrifuges	Rolling mill drives, wire-drawing machines, extruders and cableways and lifts, test bay drives
Catalog D 31.1	Catalog D 11	Catalog D 31.2	Catalog D 31.5	Catalog D 18.1	Catalog D 33 D 37.1	Catalog D 31.1	Catalog D 32	Catalog D 36.1	Catalogs D 21.3, D 21.4 NC 62	Catalog D 21.3	Catalog D 23.1, SiePortal

Engineering tools (e.g. Siemens Product Configurator, TIA Selection Tool, DriveSim Designer/Engineer, STARTER and SINAMICS Startdrive)

<sup>1)</sup> DC/DC controllers, see SiePortal.

## Overview

## SINAMICS selection guide – typical applications

Use	Requirements for torque accuracy/speed accuracy/position accuracy/coordination of axes/functionality					
	Continuous motion			Non-continuous motion		
	Basic	Medium	High	Basic	Medium	High
<b>Pumping, ventilating, compressing</b> 	Centrifugal pumps Radial / axial fans Compressors	Centrifugal pumps Radial / axial fans Compressors	Eccentric screw pumps	Hydraulic pumps Metering pumps	Hydraulic pumps Metering pumps	Descaling pumps Hydraulic pumps
	V20 G120C <b>G120X</b>	<b>G120X</b> G130/G150 G180 <sup>1)</sup> DCM	G220 S120	G120/G220	S110	S120
<b>Moving</b> 	Conveyor belts Roller conveyors Chain conveyors	Conveyor belts Roller conveyors Chain conveyors Lifting/lowering devices Elevators Escalators/moving walkways Indoor cranes Marine drives Cable railways	Elevators Container cranes Mining hoists Excavators for open-cast mining Test bays	Acceleration conveyors Storage and retrieval machines	Acceleration conveyors Storage and retrieval machines Cross cutters Reel changers	Storage and retrieval machines Robotics Pick & place Rotary indexing tables Cross cutters Roll feeds Engagers/disengagers
	V20 G115D G120C ET 200pro FC-2 <sup>2)</sup>	G120/G220 G120D G130/G150 G180 <sup>1)</sup>	G220 S120 S150 DCM	V90 S200 G120/G220 G120D	S110 S210 DCM	S120 S210 DCM
<b>Processing</b> 	Mills Mixers Kneaders Crushers Agitators Centrifuges	Mills Mixers Kneaders Crushers Agitators Centrifuges Extruders Rotary furnaces	Extruders Winders/unwinders Lead/follower drives Calenders Main press drives Printing machines	Tubular bagging machines Single-axis motion control such as • Position profiles • Path profiles	Tubular bagging machines Single-axis motion control such as • Position profiles • Path profiles	Servo presses Rolling mill drives Multi-axis motion control such as • Multi-axis positioning • Cams • Interpolations
	V20 G120C	G120/G220 G130/G150 G180 <sup>1)</sup>	G220 S120 S150 DCM	V90 S200 G120/G220	S110 S210	S120 S210 DCM
<b>Machining</b> 	Main drives for • Turning • Milling • Drilling	Main drives for • Drilling • Sawing	Main drives for • Turning • Milling • Drilling • Gear cutting • Grinding	Axis drives for • Turning • Milling • Drilling	Axis drives for • Drilling • Sawing	Axis drives for • Turning • Milling • Drilling • Lasering • Gear cutting • Grinding • Nibbling and punching
	S110	S110 S120	S120	S110	S110 S120	S120

## Using the SINAMICS selection guide

The varying range of demands on modern variable frequency drives requires a large number of different types. Selecting the optimum drive has become a significantly more complex process. The application matrix shown simplifies this selection process considerably, by suggesting the ideal SINAMICS drive for examples of typical applications and requirements.

- The application type is selected from the vertical column
  - Pumping, ventilating, compressing
  - Moving
  - Processing
  - Machining
- The quality of the motion type is selected from the horizontal row
  - Basic
  - Medium
  - High

## More information

Further information about SINAMICS is available on the internet at [www.siemens.com/sinamics](http://www.siemens.com/sinamics)

Practical application examples and descriptions are available on the internet at [www.siemens.com/sinamics-applications](http://www.siemens.com/sinamics-applications)

<sup>1)</sup> Industry-specific converters.

<sup>2)</sup> Information on the SIMATIC ET 200pro FC-2 frequency converter is available in Catalog D 31.2 and at [www.siemens.com/et200pro-fc](http://www.siemens.com/et200pro-fc)



## System overview

1

### SIMOTICS motors

#### Overview

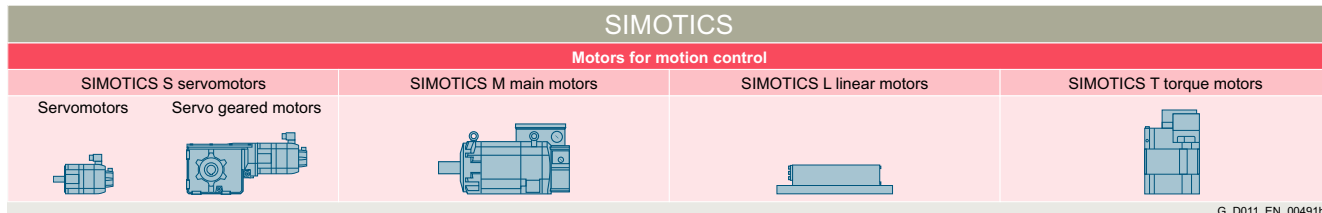

#### **SIMOTICS stands for**

- 150 years of experience in building electric motors
- The most comprehensive range of motors for motion control applications
- Optimum solutions in all industries, regions and power/performance classes
- Innovative motor technologies of the highest quality and reliability
- Highest dynamic performance, precision and efficiency together with the optimum degree of compactness
- Our motors can be integrated into the drive train as part of the overall system
- A global network of skill sets and worldwide service around the clock

#### **A clearly structured portfolio**

The entire SIMOTICS product portfolio is transparently organized according to application-specific criteria in order to help users select the optimum motor for their application.

Whatever it is that you want to move – we can supply the right motor for the task.

[www.siemens.com/simotics](http://www.siemens.com/simotics)

#### **Motors from Innomotics**

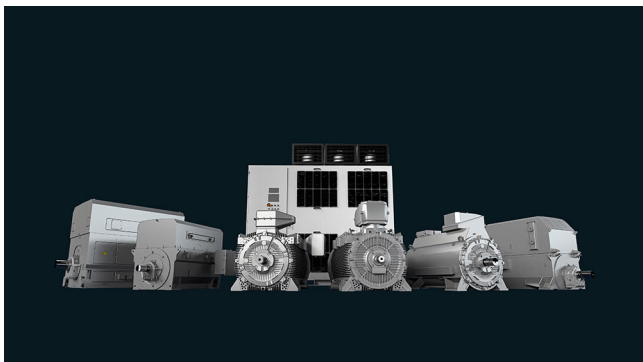

You can also find suitable motors from our product partner Innomotics

[www.innomotics.com](http://www.innomotics.com)

#### **An outstanding performance for any job**

A key characteristic of all SIMOTICS motors is their quality. They are robust, reliable, dynamic and precise to assure the requisite performance level for any process and deliver exactly the capabilities demanded by the application in hand. Thanks to their compact design, they can be integrated as space-saving units into installations. Furthermore, their impressive energy efficiency makes them effective as a means of reducing operating costs and protecting the environment.

#### **A dense network of skill sets and servicing expertise around the world**

SIMOTICS offers not only a wealth of sound experience gleaned from a development history which stretches back over around 150 years, but also the know-how of hundreds of engineers. This knowledge and our worldwide presence form the basis for a unique proximity to industries which feeds through in tangible terms to the specific motor configuration which is tailored to suit your application.

Our specialists are available to answer all your queries regarding any aspect of motor technology. At any time – wherever you are in the world. When you choose SIMOTICS, therefore, you reap the benefits of a global service network which is continuously accessible, thereby helping to optimize response times and minimize downtimes.

#### **Perfection of the complete drive train**

SIMOTICS is perfectly coordinated with other Siemens product families. In combination with the SINAMICS integrated converter family and the SIRIUS complete portfolio of industrial controls, SIMOTICS fits seamlessly as part of the complete drive train into automation solutions which are based on the SIMATIC, SIMOTION and SINUMERIK control systems.

## Overview

### Step by step to more efficiency

One of the core objectives of the European Union is a sustainable power industry. In industrial plants today, around 70 % of the power demand is from electrically driven systems. This high percentage contains huge potential for saving energy in electrical drives. For that reason, the European Union introduced minimum requirements for the energy efficiency of electric motors in the form of a statutory motor regulation as early as 2011.

These activities are extended by the 2019/1781 EU regulation dealing with stricter requirements for DOL (Direct On Line) motors and defining efficiency limits for frequency converters. The regulation provides a legal basis for technical content regarding the efficiency of specific products and services. Standardization, however, has played a leading role in determining the field and the available market technology.

Energy efficiency improvement is supported through a systematic selection of the most efficient converter and drive system technology via the IEC 61800-9 series of standards. Part 1 specifies the methodology to determine the energy efficiency index of an application based on the extended product approach (EPA) and semi analytical models (SAMs), while Part 2 provides indicators for assessing the energy efficiency performance and the classification of converters and drive systems.

To take account of the different use cases, consideration of eight application-relevant operating points has been introduced as mandatory for the first time. Determination of loss values at these eight points and definition of efficiency classes are laid down by the standard in a uniform way. This enables data relevant to operation, such as application-specific load profiles, to now be taken into account more easily in the energy efficiency analysis.

The standard is especially important for variable-speed drives of the following types:

- for AC/AC converters without energy recovery functionality
- for motors with integrated converters
- for supply voltages of 100 V to 1000 V
- for power ratings of 0.12 kW to 1000 kW

To cover all applications of driven machines, the IEC 61800-9-2 standard defines operating points in full-load and partial-load operation, at which the losses of the motor and drive systems have to be determined. Based on the loss data at the operating points in partial-load operation, variable-speed drives can be explicitly considered in more detail. This makes their advantages especially clear.

#### Centrifugal pumps, fans

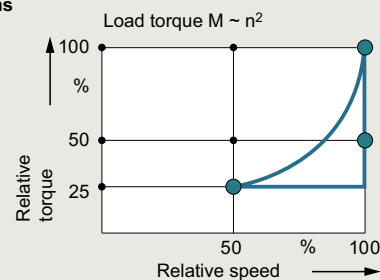

#### Hoisting gear, extruders, conveyor belts

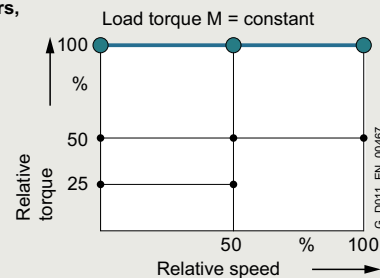
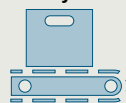

#### Winders, coilers

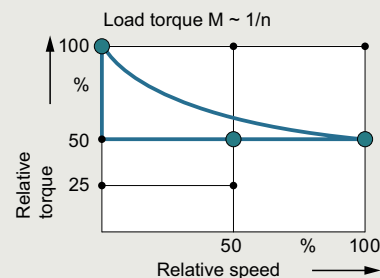

#### Duty cycles for different driven machines

Moreover, frequency converters and motor systems are classified in efficiency classes, which permit an initial rough estimate of the potential saving. Definition of reference systems is a key aspect of this because they provide standard reference values. The positioning of these reference systems defines the efficiency class. The relative distance from the reference system can be used as an absolute measure of the efficiency at the operating point in question.

## System overview

1

### Energy efficiency classes in accordance with IEC 61800-9-2

#### Overview

##### **Advantages of the detailed loss consideration of IEC 61800-9-2 over the previous consideration of efficiencies and maximum loss values**

For motors, the efficiency consideration was previously only defined for operation without a converter at 50/60 Hz. It provides a good way of comparing the energy efficiency of motors from different manufacturers for this use case.

The more detailed loss analysis of IEC 61800-9-2, on the other hand, is aimed at speed-controlled operation and therefore now also includes motors especially designed for converter operation in the energy analysis. These were previously not covered by the applicable standards.

Moreover, a loss analysis over the entire setting and load range of the motor is possible. This is done in accordance with the standard IEC 61800-9-2 with typical values.

For holistic consideration, it is essential to include all the relevant components of a drive system. The IEC 61800-9-2 standard defines this in detail. The standardized expression of power loss data as a percentage makes comparison considerably easier and more transparent.

The method also makes it possible to consider a motor that produces a holding torque at speed zero, for example. In this case, the efficiency is zero, but a power loss from current producing magnetization and holding torque does occur. In summary, the key advantage of standard IEC 61800-9-2 is the ability to perform the energy analysis of an electrical drive system based on standardized load profiles in all operating ranges due to uniform general conditions. This provides the user with complete transparency irrespective of the manufacturer.

##### **Establishing efficiency classes of frequency converters (Complete Drive Modules CDM)**

To avoid overmodulation and to ensure comparability between makes, which cannot be achieved otherwise, the efficiency classes of CDMs refer to the 90/100 operating point (90 % motor stator frequency, 100 % torque current).

Standard IEC 61800-9-2 defines the relative losses of a CDM in efficiency classes IE0 to IE2. With reference to the value of a CDM of efficiency class IE1 (reference converter), a CDM of efficiency class IE2 has 25 % lower losses and a CDM of efficiency class IE0 has 25 % higher losses.

The publication of the 2019/1781 EU regulation has made mandatory the fulfillment of the ecodesign requirements for the declaration of product conformity.

AC/AC converters belonging to the aforementioned categories (specific voltage and power level without regenerative capability) have to fulfill efficiency class IE2 in order to be approved for installation/utilization within EU.

#### Operating points for CDMs

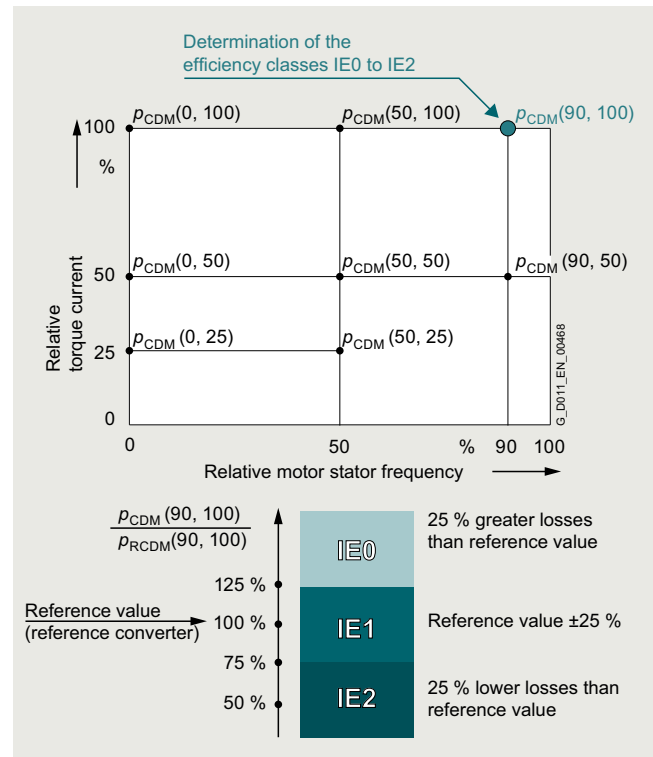

Complete Drive Module (CDM) – determining the efficiency class

##### **Establishing the efficiency classes of drive systems (Power Drive Systems PDS)**

What is possible for the individual systems, of course, also applies to the entire electrical PDS (frequency converter plus motor). Detailed comparisons are now possible at this level, too. The reference values for the reference system provide clear indications of the energy performance of the PDS.

Because targeted matching of the motor and CDM provides additional potential for optimization in electrical drive systems, it is especially important for the user to consider the entire drive system.

For the efficiency class of a PDS, too, a specific load point is defined. In this case, the reference point used is the 100/100 operating point (100 % motor stator frequency, 100 % torque).

Standard IEC 61800-9-2 defines the relative losses of a PDS in efficiency classes IES0 to IES2. With reference to the value of a PDS of efficiency class IES1 (reference drive), a PDS of efficiency class IES2 has 20 % lower losses and a PDS of efficiency class IES0 has 20 % higher losses.



Energy efficiency classes in accordance with IEC 61800-9-2

Overview

Operating points for PDS

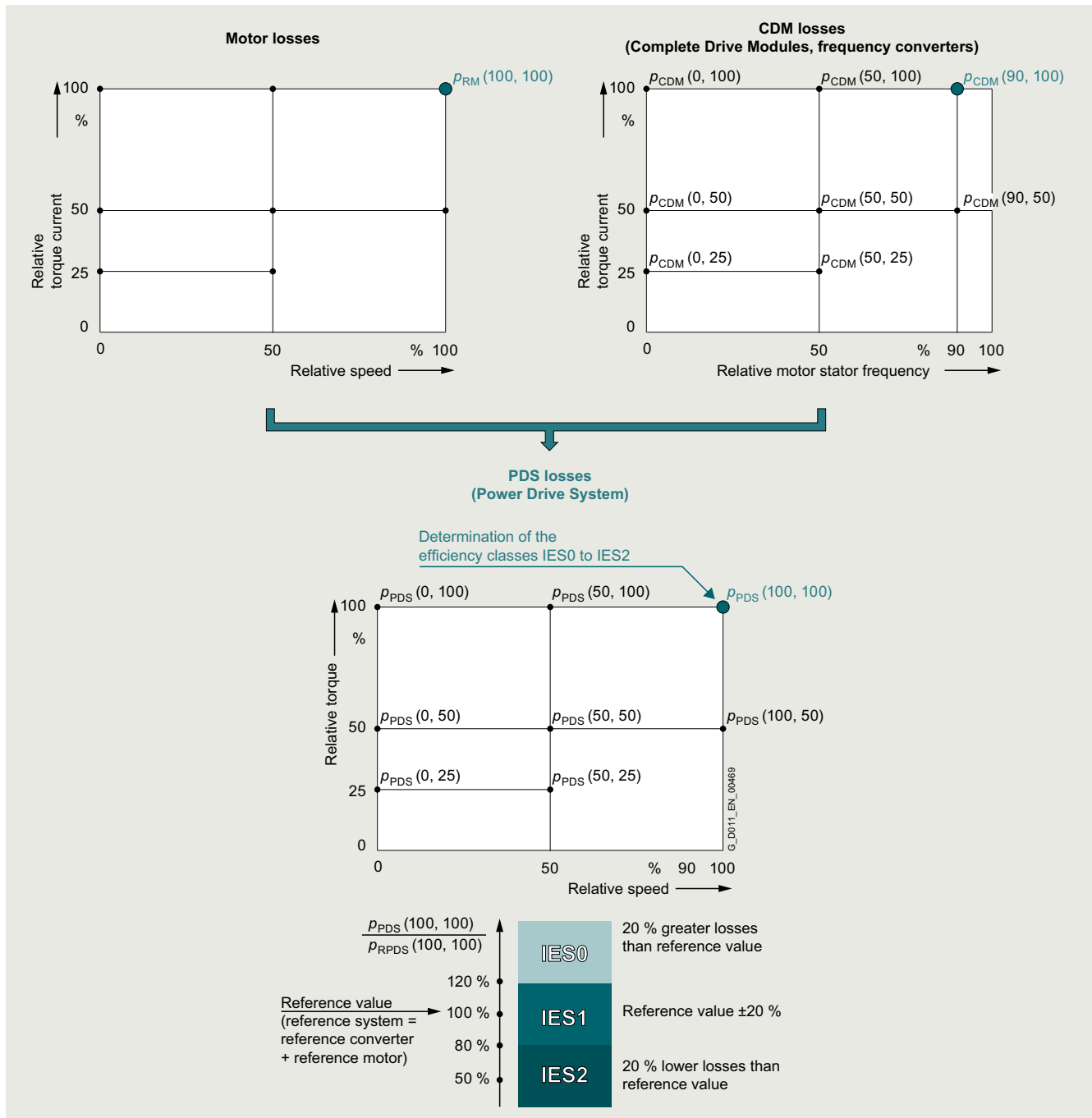

Power Drive System (PDS) – determining the efficiency class

More information

Power loss data of SINAMICS converters for single-axis drives are available

- for SINAMICS V20, SINAMICS G115D/G120/G120C/G120D/G120P/G120X/G130/G150/G180 and SINAMICS S110/S120/S150 on the internet at <https://support.industry.siemens.com/cs/document/94059311>

- for SINAMICS G220 via ID-Link or Siemens Product Configurator in SiePortal at [www.siemens.com/sinamics-g220/configuration](http://www.siemens.com/sinamics-g220/configuration)

More information on current laws and standards, new standards, and mandatory guidelines is available on the internet at [www.siemens.com/legislation-and-standards](http://www.siemens.com/legislation-and-standards)

## System overview

### SINAMICS G120X infrastructure converters for HVAC/Water/Wastewater

1

#### Overview



SINAMICS G120X, frame sizes FSA to FSJ, degree of protection IP20, with IOP-2 Intelligent Operator Panel

Easy handling, utmost reliability, superior efficiency and advanced digitalization - Siemens offers an answer to these trends with the SINAMICS G120X converter series. SINAMICS G120X is an innovative and user-friendly converter series that has been specifically developed for applications performed in infrastructure environments such as water/wastewater, but also for tasks in building automation. In this context, the converter supports, for example, pump, fan and compressor applications through numerous integrated functionalities and combines these in one device for the target sectors.

The SINAMICS G120X converter series is intended for driving pumps and fans or comparable passive load with low dynamic requirements.

With this converter series, regenerative energy can neither be regenerated to the supply system nor dissipated via braking chopper and braking resistor.

The SINAMICS G120X converter is an integrated and efficient drive solution for a wide range of tasks. The system allows convenient handling through optimized user interfaces: IOP-2 Intelligent Operator Panel with graphic color display and the optional web server module SINAMICS G120 Smart Access - a Wi-Fi-based web server solution. Thus, the SINAMICS G120X fulfils the request for an easy and fast setup of the devices during the commissioning phase. Further, experienced users can use the full flexibility of a SINAMICS converter and adjust the relevant application to their requirements.

Totally integrated operation - this approach is also supported from ordering through to delivery. For example, all the major features of the converter are configured and displayed in the article number. The delivery includes the complete device - as configured - that means, the converter and the selected operator panel.

In addition, SINAMICS G120X has an extremely rugged and reliable construction. The integrated DC link reactor with a maximum output of 250 kW and optional resistance to harmful gases up to environmental class 3C3 ensure a reliable, stable and largely robust operation.

Further, the SINAMICS G120X converter series provides innovative hardware and software functions, e.g. for controlling synchronous reluctance drive systems. In this way, the SINAMICS G120X converter series makes a substantial contribution towards saving energy and makes more careful use of our natural resources.

#### Portfolio range

The SINAMICS G120X converter series with degree of protection IP20/UL Open Type offers a seamless system approach in three different voltage ranges with wide options of built-in communication interfaces including PROFINET, EtherNet/IP, USS, Modbus RTU, BACnet MS/TP and PROFIBUS DP:

- 200 V to 240 V 3 AC: 0.75 kW to 55 kW (1 hp to 75 hp)
- 380 V to 480 V 3 AC: 0.75 kW to 560 kW (1 hp to 700 hp)
- 500 V to 690 V 3 AC: 3 kW to 630 kW (4 hp to 700 hp)

#### User-friendliness

A high degree of user-friendliness is one of the main characteristics of the SINAMICS G120X:

- Operator panel with color display and extensive diagnostics functions (IOP-2 Intelligent Operator Panel)
- Two different setup options are available: Standard and quick start with graphical user guidance
- Optimized setups for pumps and fans in the web server module SINAMICS G120 Smart Access
- SINAMICS SD card for storing parameter settings, cloning and local commissioning

#### Integrated functionalities for the start/operational/stop phases of the application

SINAMICS G120X is always preset, depending on the selected converter performance. Further, the following functions can be easily selected and parameterized:

##### Start phase

During the start phase, the following functions are supported by default:

- Deragging mode for pumps for cleaning the pump system, improving efficiency and reducing wear
- Pipe filling mode for preventing pressure shocks in pipeline systems
- Two acceleration ramps for shorter start/stop times
- Flying restart of the running motor for fast hot restart
- Automatic restart function after power failure during short downtimes

##### Operating phase

During the operating phase, the following functions are supported by default:

- Continued run mode with autonomous reduction of output and pulse frequency
- PID controller for autonomous closed-loop control mode, operated according to analog input values
- Up to 16 variable-speed setpoints as fixed frequencies
- Speed monitoring via sensor (pulse input)
- Multi-pump control of up to four pumps
- Protection against blocking, leakage, dry running and cavitation
- Fire response mode for extended operation in case of emergency
- Skip frequencies for skipping critical frequencies and avoiding vibration
- Real time clock for switching over setpoints or controlling releases

## Overview

### Stop phase

During the stop phase, the following functions are supported by default:

- STO (Safe Torque Off) according to IEC 61508 SIL 3 and EN ISO 13489-1 PL e and Category 3. External components (e.g. safety relays) are necessary for using the STO safety function.
- ON/OFF2 for an optimized braking
- Condensation protection for the motor
- Frost protection function for the pump

A detailed description of the functions and connection diagrams are included in the device documentation.

### **Commissioning of complex applications**

Sample applications, which include the description and device setting, are provided for SINAMICS G120X.

The following application descriptions are available:

- Fan for exhaust air with closed-loop control of pressure and air quality
- Fan for cooling tower with closed-loop control of the cooling water temperature
- Fan for tunnel/parking garage with closed-loop control of air quality and essential service mode
- Fan for supply air with closed-loop control of pressure, temperature, air quality and flowrate
- Pumps with closed-loop control of the pressure
- Pumps with closed-loop control of the filling level
- Pumps for cooling circuits with closed-loop control of the temperature
- Compressor with closed-loop control of the pressure
- Vacuum pump with closed-loop control of the pressure

Practical application examples and descriptions are available on the internet at

[www.siemens.com/sinamics-applications](http://www.siemens.com/sinamics-applications)

### **Further information**

The converter is also available as SINAMICS G120X Cabinet version for more demanding projects. For more information, please contact your regional sales representative.



# System overview

## SINAMICS G120X Starter Kits

1

### Overview

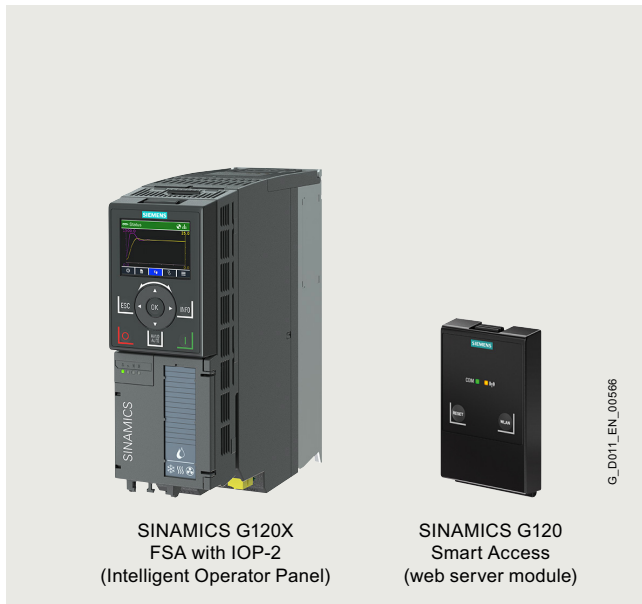

SINAMICS G120X  
FSA with IOP-2  
(Intelligent Operator Panel)

SINAMICS G120  
Smart Access  
(web server module)

Example: SINAMICS G120X Starter Kit, frame size FSA, 0.75 kW, with IOP-2 Intelligent Operator Panel and SINAMICS G120 Smart Access

A SINAMICS G120X Starter Kit comprises a SINAMICS G120X converter (380 ... 480 V 3 AC; PROFINET) with an IOP-2 Intelligent Operator Panel and a SINAMICS G120 Smart Access web server module.

The delivery quantity is limited to three units per customer.

### Selection and ordering data

Description	Article No.
<b>SINAMICS G120X Starter Kits</b> Converter (380 ... 480 V 3 AC, PROFINET) with IOP-2 and SINAMICS G120 Smart Access	
• 0.75 kW, FSA, without integrated line filter	<b>6SL3200-0AE70-0AA0</b>
• 0.75 kW, FSA, with integrated line filter Category C2	<b>6SL3200-0AE72-0AA0</b>
• 3 kW, FSA, with integrated line filter Category C2	<b>6SL3200-0AE73-0AA0</b>
• 7.5 kW, FSB, with integrated line filter Category C2	<b>6SL3200-0AE74-0AA0</b>

# SINAMICS G120X infrastructure converters for HVAC/Water/Wastewater

## 0.75 kW to 630 kW (1 hp to 700 hp)

2



<b>2/2</b>	<b>SINAMICS G120X infrastructure converters for HVAC/Water/Wastewater</b>	<b>2/52</b>	<b>Supplementary system components</b>
2/2	Overview	2/52	Operator Panels
2/3	Benefits	2/53	• IOP-2 Intelligent Operator Panel
2/4	Application	2/56	• BOP-2 Basic Operator Panel
2/4	Design	2/57	Memory cards
2/5	Function	2/58	SINAMICS G120 Smart Access
2/6	Integration	2/59	SINAMICS G120X I/O Extension Module
2/8	Configuration	2/60	Push-through mounting frames for frame sizes FSA to FSG
2/10	Selection and ordering data	2/60	IP21 top covers for frame sizes FSA to FSG
2/10	• SINAMICS G120X converters · Degree of protection IP20/UL Open Type · 200 ... 240 V 3 AC	2/61	Wiring adapter for frame size FSG
2/11	- Configuration with line-side components	2/62	Installation kit for line-side cable connection, left, for frame size FSH
2/13	- Configuration with load-side power components	<b>2/62</b>	<b>Spare parts</b>
2/14	• SINAMICS G120X converters · Degree of protection IP20/UL Open Type · 380 ... 480 V 3 AC	2/62	FPI board for frame sizes FSH and FSJ
2/15	- Configuration with line-side components	2/62	PSB board for frame sizes FSH and FSJ
2/17	- Configuration with load-side power components	2/62	Current transformers for frame sizes FSH and FSJ
2/18	• SINAMICS G120X converters · Degree of protection IP20/UL Open Type · 500 ... 690 V 3 AC	2/63	Spare parts kit for Control Unit
2/19	- Configuration with line-side components	2/63	Shield connection kit for Control Unit
2/21	- Configuration with load-side power components	2/63	Shield connection kits for Power Module
2/22	• Supplementary system components and spare parts for SINAMICS G120X converters	2/63	Small parts assembly set for frame sizes FSD to FSG
2/23	Technical specifications	2/64	Terminal cover kits for frame sizes FSD to FSG
2/46	Characteristic curves	2/64	Fan units
2/51	Dimensional drawings	2/64	Control Units
2/51	More information		

Further information about SINAMICS G120X can be found on the internet at [www.siemens.com/sinamics-g120x](http://www.siemens.com/sinamics-g120x)

## SINAMICS G120X infrastructure converters for HVAC/Water/Wastewater

0.75 kW to 630 kW (1 hp to 700 hp)

### SINAMICS G120X infrastructure converters for HVAC/Water/Wastewater

#### Overview



SINAMICS G120X, frame sizes FSA to FSJ, degree of protection IP20, with IOP-2 Intelligent Operator Panel

Easy handling, utmost reliability, superior efficiency and advanced digitalization - Siemens offers an answer to these trends with the SINAMICS G120X converter series. SINAMICS G120X is an innovative and user-friendly converter series that has been specifically developed for applications performed in infrastructure environments such as water/wastewater, but also for tasks in building automation. In this context, the converter supports, for example, pump, fan and compressor applications through numerous integrated functionalities and combines these in one device for the target sectors.

The SINAMICS G120X converter series is intended for driving pumps and fans or comparable passive load with low dynamic requirements.

With this converter series, regenerative energy can neither be regenerated to the supply system nor dissipated via braking chopper and braking resistor.

The SINAMICS G120X converter is an integrated and efficient drive solution for a wide range of tasks. The system allows convenient handling through optimized user interfaces: IOP-2 Intelligent Operator Panel with graphic color display and the optional web server module SINAMICS G120 Smart Access - a Wi-Fi-based web server solution. Thus, the SINAMICS G120X fulfills the request for an easy and fast setup of the devices during the commissioning phase. Further, experienced users can use the full flexibility of a SINAMICS converter and adjust the relevant application to their requirements.

Totally integrated operation - this approach is also supported from ordering through to delivery.

For example, all the major features of the converter are configured and displayed in the article number. The delivery includes the complete device - as configured - that means, the converter and the selected operator panel.

In addition, SINAMICS G120X has an extremely rugged and reliable construction. The integrated DC link reactor with a maximum output of 250 kW and optional resistance to harmful gases up to environmental class 3C3 ensure a reliable, stable and largely robust operation.

Further, the SINAMICS G120X converter series provides innovative hardware and software functions, e.g. for controlling synchronous reluctance drive systems. In this way, the SINAMICS G120X converter series makes a substantial contribution towards saving energy and makes more careful use of our natural resources.

#### Portfolio range

The SINAMICS G120X converter series with degree of protection IP20/UL Open Type offers a seamless system approach in three different voltage ranges with wide options of built-in communication interfaces including PROFINET, EtherNet/IP, USS, Modbus RTU, BACnet MS/TP and PROFIBUS DP:

- 200 V to 240 V 3 AC: 0.75 kW to 55 kW (1 hp to 75 hp)
- 380 V to 480 V 3 AC: 0.75 kW to 560 kW (1 hp to 700 hp)
- 500 V to 690 V 3 AC: 3 kW to 630 kW (4 hp to 700 hp)

#### User-friendliness

A high degree of user-friendliness is one of the main characteristics of the SINAMICS G120X:

- Operator panel with color display and extensive diagnostics functions (IOP-2 Intelligent Operator Panel)
- Two different setup options are available: Standard and quick start with graphical user guidance
- Optimized setups for pumps and fans in the web server module SINAMICS G120 Smart Access
- SINAMICS SD card for storing parameter settings, cloning and local commissioning

#### Integrated functionalities for the start/operational/stop phases of the application

SINAMICS G120X is always preset, depending on the selected converter performance. Further, the following functions can be easily selected and parameterized:

##### Start phase

During the start phase, the following functions are supported by default:

- Deragging mode for pumps for cleaning the pump system, improving efficiency and reducing wear
- Pipe filling mode for preventing pressure shocks in pipeline systems
- Two acceleration ramps for shorter start/stop times
- Flying restart of the running motor for fast hot restart
- Automatic restart function after power failure during short downtimes

##### Operating phase

During the operating phase, the following functions are supported by default:

- Continued run mode with autonomous reduction of output and pulse frequency
- PID controller for autonomous closed-loop control mode, operated according to analog input values
- Up to 16 variable-speed setpoints as fixed frequencies
- Speed monitoring via sensor (pulse input)
- Multi-pump control of up to four pumps
- Protection against blocking, leakage, dry running and cavitation
- Fire response mode for extended operation in case of emergency
- Skip frequencies for skipping critical frequencies and avoiding vibration
- Real time clock for switching over setpoints or controlling releases



# SINAMICS G120X infrastructure converters for HVAC/Water/Wastewater

0.75 kW to 630 kW (1 hp to 700 hp)

## SINAMICS G120X infrastructure converters for HVAC/Water/Wastewater

### Overview

#### Stop phase

During the stop phase, the following functions are supported by default:

- STO (Safe Torque Off) according to IEC 61508 SIL 3 and EN ISO 13489-1 PL e and Category 3. External components (e.g. safety relays) are necessary for using the STO safety function.
- ON/OFF2 for an optimized braking
- Condensation protection for the motor
- Frost protection function for the pump

A detailed description of the functions and connection diagrams are included in the device documentation.

#### Commissioning of complex applications

Sample applications, which include the description and device setting, are provided for SINAMICS G120X.

The following application descriptions are available:

- Fan for exhaust air with closed-loop control of pressure and air quality
- Fan for cooling tower with closed-loop control of the cooling water temperature
- Fan for tunnel/parking garage with closed-loop control of air quality and essential service mode
- Fan for supply air with closed-loop control of pressure, temperature, air quality and flowrate
- Pumps with closed-loop control of the pressure
- Pumps with closed-loop control of the filling level
- Pumps for cooling circuits with closed-loop control of the temperature
- Compressor with closed-loop control of the pressure
- Vacuum pump with closed-loop control of the pressure

Practical application examples and descriptions are available on the internet at

[www.siemens.com/sinamics-applications](http://www.siemens.com/sinamics-applications)

#### Further information

The converter is also available as SINAMICS G120X Cabinet version for more demanding projects. For more information, please contact your regional sales representative.

### Benefits

#### Energy efficiency

SINAMICS G120X increases the efficiency and minimizes energy consumption in the complete process chain. The converter has integrated hardware as well as software functions as standard. The main features are:

- Power units with DC link reactor for extremely high active power component thanks to efficient converter topology - for the same drive power, the converter requires a lower line current than comparable converters
- Flux reduction through automatic adaptation of the motor current to the prevailing load conditions with closed-loop control modes V/f (ECO) and vector without sensor (SLVC) and savings of up to 5 % under partial load conditions
- Hibernation mode dependent on setpoints in the process
- High efficiency  $\eta \geq 95\%$

#### Application-specific commissioning and operation using operator panel

- Local commissioning without specialized knowledge of converters thanks to default settings and graphical user interface
- Unique: SINAMICS SD memory card for pre-parameterization and cloning of converter data sets
- Data backup for easy replacement
- Commissioning/diagnostics and controlling of converters

#### Flexible deployment of integrated functions

- PLC functions for local control tasks for frame sizes FSA to FSG  
Flexible use of integrated function blocks  
→ No need for additional, external components
- Four integrated PID controllers  
Distributed closed-loop control for motor-independent process control without higher-level controller (PLC)
- Three freely programmable digital timer switches  
Control for freely selectable daily and weekly programs

#### Flexible deployment across a wide range of applications

- Isolated digital inputs with separate potential group
- Isolated analog inputs  
- Potential transfer avoided  
- EMC-compliant design without the need for additional components in line with process industry requirements
- Direct connection of Pt1000/Ni1000 temperature sensors with optional SINAMICS G120X I/O Extension Module
- Connection and evaluation of a recommended, optional Pt1000 temperature sensor by using a free analog input and output
- 2/3-wire control for static/pulsed signals for universal control via digital inputs
- 230 V AC relay  
- Direct control for auxiliary equipment, e.g. reactor or valve actuators
- Safety functions  
- Terminals for controlling the STO (Safe Torque Off) Safety function according to IEC 61508 SIL 3 and EN ISO 13489-1 PL e and Category 3.  
External components (e.g. safety relays) are necessary for using the STO safety function.
- X9 terminal strip for devices in frame sizes FSH and FSJ (315 kW to 630 kW)  
- Input for external 24 V DC supply  
- Input for external alarm/fault  
- Input for EMERGENCY OFF/EMERGENCY STOP  
- Output for 24 V DC  
- Control of the main contactor  
- Feedback message "DC link charged"
- Use of the communication versions at ambient temperatures of  
- -20 °C to +55 °C: PROFINET, EtherNet/IP  
- -20 °C to +60 °C: PROFIBUS DP, USS, Modbus RTU, BACnet MS/TP
- Removable operator panel  
- Protection against unauthorized access  
- Color-coded signaling of operating states
- Replacement of individual components without the need for reinstallation  
- Plug-in version of control terminals (for replacement without removing wiring)
- Version for harsh environmental conditions  
- Coated modules for increased resistance to humidity and dust (Class 3C2)  
- PCB coating for environmental class/harmful chemical substances Class 3C3 acc. to IEC 60721-3-3: 2002

#### Extended warranty

For SINAMICS G120X, Siemens offers an optional extension of warranty up to 5½ years via **Service Protect**:

- Free for the first 6 months after registering the product at: <https://myregistration.siemens.com>
- Subject to a charge for a further 3 or 5 years

For further information, go to:

<https://support.industry.siemens.com/cs/ww/en/sc/4842>

Concerning standard warranty please ask your partner at Siemens. Your partner can be found in our Personal Contacts Database at:

[www.siemens.com/automation-contact](http://www.siemens.com/automation-contact)

## SINAMICS G120X infrastructure converters for HVAC/Water/Wastewater

0.75 kW to 630 kW (1 hp to 700 hp)

### SINAMICS G120X infrastructure converters for HVAC/Water/Wastewater

#### Application

##### *The specialist for pump, fan and compressor applications*

SINAMICS G120X is ideally suited to pump applications (centrifugal pumps, oscillating and rotating pumps), fan applications (axial and radial fans) and compressor applications (cooling compressors, air and gas compressors). They are deployed in the water/waste water industries, in industrial environments, and in building automation.

SINAMICS G120X is ideally suited for the following applications:

- Circulating pumps for heating and cooling systems
- Pumps for pressure boosting stations
- Level control
- Fans in cooling towers
- Fans for air intake and discharge
- Fans for tunnels and multi-story car parks
- Fans for stairwells
- Compressors for cooling units

The SINAMICS G120X converter series is intended for driving pumps and fans or comparable passive load with low dynamic requirements.

With this converter series, regenerative energy can neither be regenerated to the supply system nor dissipated via braking chopper and braking resistor.

##### *Reliable operation in harsh environments*

SINAMICS G120X is suitable for use under harsh environmental conditions:

- Degree of protection IP20/UL Open Type for use in the control cabinet
- Degree of protection IP21 with optional IP21 top cover for use in lockable control rooms, including outside a control cabinet
- Degree of protection IP20 with optional push-through mounting frame for space-saving design when installed in the control cabinet; power losses are dissipated using an external heat sink, separate internal air circulation
- Use of the communication versions at ambient temperatures of
  - -20 °C to +55 °C: PROFINET, EtherNet/IP
  - -20 °C to +60 °C: PROFIBUS DP, USS, Modbus RTU, BACnet MS/TP
- Coated modules for increased resistance to humidity and dust (Class 3C2)
- Optional for environmental class/harmful chemical substances Class 3C3 acc. to IEC 60721-3-3: 2002

#### Design

SINAMICS G120X is a converter system that comprises a power output module and a control module with or without an operator panel.

The converter is configured on the basis of the power requirement and the application. State-of-the-art IGBT technology with pulse-width modulation is used for reliable and flexible motor operation. Comprehensive protection functions provide a high degree of protection for the converter and motor.

The SINAMICS G120X converters in degree of protection IP20 are intended for installation in a control cabinet.

- Selection of the line filter for line voltage 200 V to 240 V 3 AC
  - Without integrated line filter, 0.75 kW to 55 kW
- Selection of the line filter for line voltage 380 V to 480 V 3 AC
  - Without integrated line filter, 0.75 kW to 132 kW
  - With integrated line filter Category C2, 0.75 kW to 250 kW
  - With integrated line filter Category C3, 160 kW to 560 kW
  - With additional line filter Category C1 for unfiltered devices, 0.75 kW to 110 kW
  - With additional line filter Category C2 for filtered devices, 315 kW to 560 kW

- Selection of the line filter for line voltage 500 V to 690 V 3 AC
  - Without integrated line filter, 3 kW to 132 kW
  - With integrated line filter Category C2, 3 kW to 55 kW
  - With integrated line filter Category C3, 75 kW to 630 kW
  - With additional line filter Category C2 for filtered devices, 315 kW to 630 kW
- Environmental class/harmful chemical substances acc. to IEC 60721-3-3: 2002
  - Class 3C2
  - Class 3C3
- Selection of communication
  - PROFINET, EtherNet/IP
  - PROFIBUS
  - USS, Modbus RTU, BACnet MS/TP
- Selection of the operator panel
 

The operator panels support user-friendly local commissioning, control and diagnostics and enable complete converter data sets to be pre-parameterized and cloned.

  - Without operator panel
  - BOP-2 Basic Operator Panel
 

The menu prompting and the 2-line display allow for simple commissioning of the converter. Simultaneous display of the parameter and parameter value, as well as parameter filtering, means that basic commissioning of a drive can also be performed without a printed parameter list.
  - IOP-2 Intelligent Operator Panel
 

Supports entry-level personnel as well as drive experts. Thanks to the color display, a user-friendly menu structure and wizards, it is much easier to commission, diagnose and locally control standard drives.

##### *Line-side power components*

The following line-side power components are available for the SINAMICS G120X converters:

- Line filters for categories C1, C2 and C3, see above
 

With an additional line filter, the converter complies with a higher radio interference class.
- Line harmonics filters for frame sizes FSB from 5.5 kW to FSG up to 250 kW
 

The use of a line harmonics filter enables a significant reduction in unwanted harmonics. This means that a THD (I) value of less than 5 % can be achieved and compliance with the limit values according to IEC 61000-3-12, IEC 61000-2-2 and IEEE 519 is possible regardless of the network impedance.
- Line reactors for devices from 315 kW and for frame sizes FSH and FSJ
 

Line reactors smooth the current drawn by the converter and thus reduce harmonic components in the line current. Through the reduction of the current harmonics, the thermal load on the power components in the rectifier and in the DC link capacitors is reduced as well as the harmonic effects on the supply. The use of a line reactor increases the service life of the converter.

SINAMICS G120X frame sizes FSA to FSG feature an integrated DC link reactor as standard. The use of an additional line reactor is not necessary for this.

##### *Recommended line-side overcurrent protection devices and power components*

This section contains recommendations for additional line-side components, such as Siemens fuses and circuit breakers (line-side components must be dimensioned in accordance with IEC standards).

[Additional information about the listed fuses and circuit breakers is available in the Catalogs LV 10, IC 10 and IC 10 AO as well as in SiePortal.](#)

# SINAMICS G120X infrastructure converters for HVAC/Water/Wastewater

0.75 kW to 630 kW (1 hp to 700 hp)

## SINAMICS G120X infrastructure converters for HVAC/Water/Wastewater

### Design

#### Load-side power components

Various load-side power components are available for the SINAMICS G120X converters. These allow the use of longer shielded motor cables and increase the motor service life:

- Output reactors for frame sizes FSD to FSJ  
Output reactors reduce the rate of voltage rise (dv/dt) and the height of the current peaks, and can allow longer motor cables to be connected.
- Sine-wave filters for frame sizes FSA to FSF  
Sine-wave filters limit the rate of voltage rise (dv/dt) and the peak voltages on the motor winding. Similar to an output reactor, they enable the connection of longer motor cables.
- dv/dt filters plus VPL for frame sizes FSD to FSJ  
dv/dt filters plus VPL (Voltage Peak Limiter) limit the voltage rate-of-rise dv/dt to values of <math><500\text{ V}/\mu\text{s}</math> and the typical voltage peaks to values according to the limit value curve according to IEC/TS 60034-17: 2006.  
Standard motors with standard insulation and without insulated bearings can be used for converter operation if a dv/dt filter plus VPL is used.

#### Optional accessories

- SINAMICS memory card (SD card)
- SINAMICS G120 Smart Access for simple setup via Wi-Fi
- SINAMICS G120X I/O Extension Module for direct connection of Pt1000/Ni1000 temperature sensors <sup>1)</sup>
- Push-through mounting frame for frame sizes FSA to FSG
- Increase in degree of protection to IP21 with IP21 top covers for frame sizes FSA to FSG
- Wiring adapter for frame size FSG for optimal and space-saving wiring
- Installation kit for line-side cable connection, left, for frame size FSH

#### Note:

Shield connection kits are an integral component of the delivery.

#### Spare parts

- FPI (freely programmable interface) board for frame sizes FSH and FSJ
- PSB (power supply board) board for frame sizes FSH and FSJ
- Current transformers for frame sizes FSH and FSJ
- Spare parts kit for Control Unit for frame sizes FSA and FSJ
- Shield connection kit for Control Unit for frame sizes FSD to FSG
- Shield connection kits for Power Module for frame sizes FSA to FSG
- Small parts assembly set for frame sizes FSD to FSG
- Terminal cover kits for covering the connecting terminals for frame sizes FSD to FSG
- Fan units
  - External for frame sizes FSA to FSJ
  - Internal for frame sizes FSH and FSJ
- Control Units for frame sizes FSD to FSJ

### Function

#### Technology function

Functions specific to pumps, fans and compressors are already integrated, e.g.:

- Specific firmware functions such as deragging or pipe fill mode
- Automatic restart  
Application restart after a power failure or fault occurrence
- Flying restart  
Connection of the converter when the motor is running
- Flux reduction  
Automatic adaptation of the motor current to the prevailing load conditions in V/f control mode (ECO mode) as well as in sensorless vector control mode
- Cascade connection  
Load-dependent connection and disconnection of a maximum of three additional motors by the converter in order to provide a largely constant output power (implemented by means of an additional external circuit)
- Hibernation mode  
Startup or shutdown of the drive when the relevant value drops below an external setpoint or the internal PID controller setpoint
- Real-time clock  
For time-dependent process controls, e.g. to reduce the temperature of a heating control at night and with automatic day-light saving/standard time switchover
- Freely programmable logical function blocks for frame sizes FSA to FSG  
For simulating simple PLC functions

#### Functions especially for building technology as well as heating/air conditioning/ventilation applications

- Four integrated PID controllers  
One PID controller for controlling the drive speed as a function of pressure, temperature, flowrate, fill level, air quality and other process variables; a further three PID controllers with freely configurable outputs, e.g. for controlling valves (heating, cooling) or flaps
- Emergency mode  
Special converter operating mode that enhances the availability of the drive system in the event of a fire
- Bypass mode  
When the setpoint is reached or a fault occurs, the system changes over to line operation (implemented by means of an additional external circuit)
- Programmable time switches

<sup>1)</sup> The SINAMICS G120X I/O Extension Module (article number: **6SL3255-0BE00-0AA0**) is only supported on the SINAMICS G120X converters with hardware version  $\geq 02\ 02$  (FSA to FSG) /  $02$  (FSH/FSJ) and firmware  $\geq V1.01$ .  
The hardware version of the converter is on the rating plate.  
For more information please refer to the documentation on the internet at: [www.siemens.com/sinamics-g120x/documentation](http://www.siemens.com/sinamics-g120x/documentation)



# SINAMICS G120X infrastructure converters for HVAC/Water/Wastewater

0.75 kW to 630 kW (1 hp to 700 hp)

## SINAMICS G120X infrastructure converters for HVAC/Water/Wastewater

### Integration

2

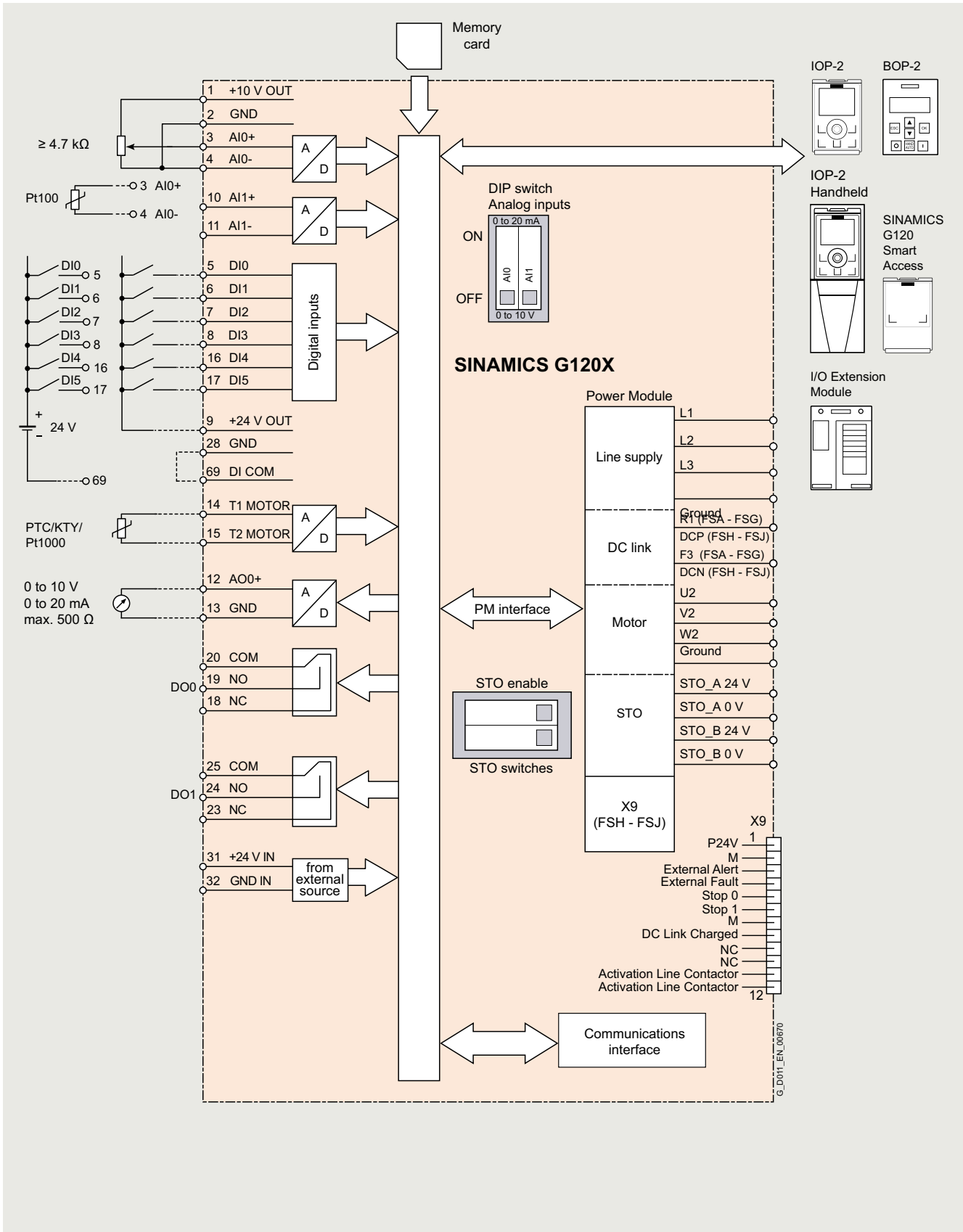

SINAMICS G120X connection diagram

# SINAMICS G120X infrastructure converters for HVAC/Water/Wastewater

0.75 kW to 630 kW (1 hp to 700 hp)

## SINAMICS G120X infrastructure converters for HVAC/Water/Wastewater

### Integration

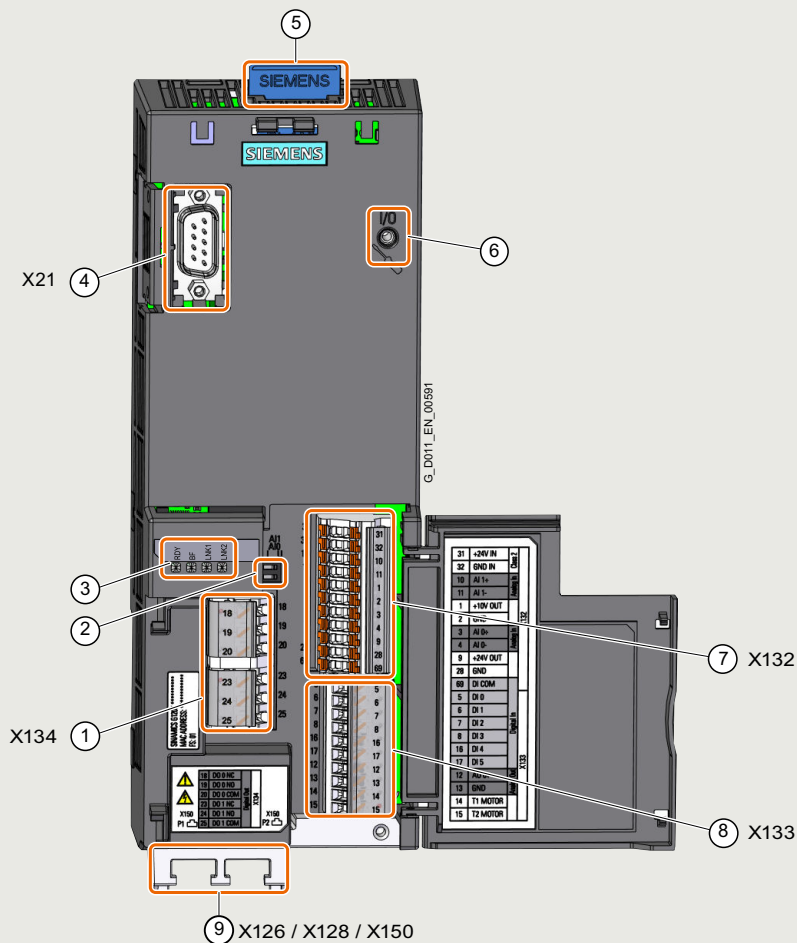

- ① Terminal strip
- ② Switch for AI 0 and AI 1 (I/V)
- ③ Status LED
- ④ Connection to Operator Panel, Smart Access or I/O Extension Module
- ⑤ Memory card slot
- ⑥ For mounting the I/O Extension Module
- ⑦ ⑧ Terminal strips
- ⑨ Fieldbus interfaces on the bottom

SINAMICS G120X interface overview



## SINAMICS G120X infrastructure converters for HVAC/Water/Wastewater

0.75 kW to 630 kW (1 hp to 700 hp)

### SINAMICS G120X infrastructure converters for HVAC/Water/Wastewater

#### Configuration

The following electronic configuring guides and engineering tools are available for SINAMICS G120X converters:

##### **SINAMICS Selector app**

###### Mobile selection guide for frequency converters

Siemens has developed the SINAMICS Selector app as a practical tool for finding article numbers for your SINAMICS converters in the power range from 0.1 kW to 630 kW quickly and easily. Whether for SINAMICS V20, SINAMICS V90, SINAMICS G120C, SINAMICS G120P, SINAMICS G120X, SINAMICS G120, SINAMICS G220, SINAMICS S200 or SINAMICS S210:

The app will provide you with the correct article numbers conveniently.

How does it work? Simply select your application, the frequency converter you require, the rated power and device options as well as the necessary accessories.

Then you can save your selection and send it by email. Your pre-selection is the basis for an order specification with the dealer/Siemens.

You will find the free downloads for Android and for iOS at the following link:

[www.siemens.com/sinamics-selector](http://www.siemens.com/sinamics-selector)

##### **SINAMICS ASSISTANT app**

The error code function of the SINAMICS ASSISTANT app helps you to identify and rectify errors. Just enter the error code of your frequency converter and the app shows you what sort of error it is and how you can rectify it.

This app also recalculates for you the frequency (Hz) of a frequency converter into the speed to be set on the motor (r/min) or vice versa.

In addition, this app offers you a support page on which you can get in touch straight away with the right contact person in your region if you have any questions. Furthermore, video information is available to you free of charge, e.g. on installation and commissioning of the SINAMICS G120 frequency converter.

You will find the free downloads for Android and for iOS at the following link:

[www.siemens.com/sinamics-assistant](http://www.siemens.com/sinamics-assistant)

##### **SINAMICS DriveSim Designer (firmware V1.03.00 or higher)**

SINAMICS DriveSim Designer provides easy-to-use models for PROFIdrive-enabled SINAMICS converters, so you can create a digital twin of your drive.

More information is provided on the internet at:

[www.siemens.com/drive-virtualization](http://www.siemens.com/drive-virtualization)

##### **Siemens Product Configurator**

The Siemens Product Configurator helps you to configure the optimum drive technology products for a number of applications – starting with gear units, motors, converters as well as the associated options and components and ending with controllers, software licenses and connection systems.

The Siemens Product Configurator can be used on the internet without requiring any installation. The Siemens Product Configurator can be found in SiePortal at the following address: [www.siemens.com/spc](http://www.siemens.com/spc)

You can find further information on the Siemens Product Configurator in the Engineering tools section.

##### **TIA Selection Tool**

###### Selection tool and configurator for automation technology

Flawless configuration without expert knowledge through intelligent configurators and selection wizards. Desktop and cloud versions enable cross-team work with maximum flexibility.

There are two versions of the TIA Selection Tool:

- One for downloading and executing on Microsoft Windows PCs (from Microsoft Windows 10)
- One for running from the cloud, which is launched from mobile devices directly in the browser (we recommend Safari, Chrome and Firefox)

Projects stored in the cloud can be edited with both tools. This makes it possible to work on-the-go using a tablet, at home on a PC – and vice versa, or together with colleagues and customers.

In order to use the full functionality, we recommend setting up a SiePortal account for both cases. This gives you access to prices and enables you to save your projects to our cloud.

You can find more information on the TIA Selection Tool at [www.siemens.com/tia-selection-tool](http://www.siemens.com/tia-selection-tool)

##### **SIMARIS planning tools for plants with SINAMICS drives**

###### Electrical planning: Even easier with software!

Electrical planning for power distribution in non-residential and industrial buildings has never been more complex. To ensure you, as a specialist planner, have the best hand when it comes to electrical planning with SINAMICS drives, we provide support with the following efficient software tools: SIMARIS design for dimensioning and SIMARIS project for calculating the space requirements of the distribution boards.

You can find more information on the SIMARIS planning tools for plants with SINAMICS drives in the Engineering tools section.

##### **SinaSave energy efficiency tool**

###### Use SinaSave to calculate potential energy savings

The web-based tool SinaSave can be used to estimate the potential savings which can be achieved over the entire lifecycle, e.g. for pump and fan applications, thanks to SINAMICS. The tool takes into consideration all important plant-specific quantities, such as the power and load data of the application, the relevant control mode and the operation profile for the application in question. The result delivered by the tool specifies the potential energy savings which can be achieved with the specific application in conjunction with all drive components. The tool also provides a monetary evaluation of the potential savings and estimates the payback period.

You can find more information about the amortization calculator for energy-efficient drive systems at

[www.siemens.com/sinasave](http://www.siemens.com/sinasave)

You can find further information on the SinaSave energy efficiency tool in the Engineering tools section.

# SINAMICS G120X infrastructure converters for HVAC/Water/Wastewater

0.75 kW to 630 kW (1 hp to 700 hp)

## SINAMICS G120X infrastructure converters for HVAC/Water/Wastewater

### Configuration

#### ***SIZER for Siemens Drives engineering tool (integrated into TIA Selection Tool)***

The SIZER for Siemens Drives engineering tool makes it easy to configure the SINAMICS converter family. It provides support when selecting the hardware and firmware components necessary to implement a drive task. SIZER for Siemens Drives is designed to support configuring of the entire drive system.

The SIZER for Siemens Drives engineering tool is available free on the internet at [www.siemens.com/sizer](http://www.siemens.com/sizer)

You can find further information on the SIZER for Siemens Drives engineering tool in the Engineering tools section.

#### ***Drive ES PCS 7 engineering system***

Drive ES PCS 7 integrates drives into the SIMATIC PCS 7 process control system. Drive ES PCS 7 provides a block library with blocks for the drives and the corresponding faceplates for the operator station.

More information about the Drive ES engineering system is available on the internet at [www.siemens.com/drive-es](http://www.siemens.com/drive-es)

#### ***SINAMICS web server for SINAMICS G120X via SINAMICS G120 Smart Access***

Web server for efficient commissioning, diagnostics and maintenance

The optionally available SINAMICS G120 Smart Access provides the SINAMICS G120X drive system with a web server for efficient commissioning, diagnostics and maintenance. The web server provides access to a multi-faceted range of new options for parameter assignment and drive diagnostics for laptops, tablets and smartphones.

You can find further information on the SINAMICS web server for SINAMICS G120X via SINAMICS G120 Smart Access in the Engineering tools section.



# SINAMICS G120X infrastructure converters for HVAC/Water/Wastewater

0.75 kW to 630 kW (1 hp to 700 hp)

Clicking to SiePortal

6SL3255-0AA00-5AA0



## SINAMICS G120X infrastructure converters for HVAC/Water/Wastewater

### Selection and ordering data

SINAMICS G120X converters · Degree of protection IP20/UL Open Type · 200 ... 240 V 3 AC → Configuration with line-side components (see right page)

Rated power <sup>1)</sup>		Rated output current <sup>2)</sup>		Base-load current $I_L$ <sup>3)</sup>		Rated input current <sup>4)</sup>	Frame size	SINAMICS G120X Degree of protection IP20/UL Open Type without integrated line filter
200 V kW	240 V hp	200 V A	240 V A	200 V A	240 V A	200 V A		Article No.
<b>200 ... 240 V 3 AC · Rated pulse frequency 4 kHz · Input frequency 47 ... 63 Hz</b>								
0.75	1	4.2	4.2	3.2	3.2	3.8	FSA	6SL32 0-0 YC10- U U 0
1.1	1.5	6	6	4.2	4.2	5.4	FSA	6SL32 0-0 YC12- U U 0
1.5	2	7.4	7.4	6	6	6.7	FSA	6SL32 0-0 YC14- U U 0
2.2	3	10.4	10.4	7.4	7.4	9.6	FSB	6SL32 0-0 YC16- U U 0
3	4	13.6	13.6	10.4	10.4	12.7	FSB	6SL32 0-0 YC18- U U 0
4	5	17.5	17.5	13.6	13.6	16.3	FSB	6SL32 0-0 YC20- U U 0
5.5	7.5	22	22	17.5	17.5	20.8	FSC	6SL32 0-0 YC22- U U 0
7.5	10	28	28	22	22	26.3	FSC	6SL32 0-0 YC24- U U 0
11	15	42	42	28	28	40	FSD	6SL32 0-0 YC26- U U 0
15	20	54	54	42	42	51	FSD	6SL32 0-0 YC28- U U 0
18.5	25	68	68	54	54	64	FSD	6SL32 0-0 YC30- U U 0
22	30	80	80	68	68	76	FSE	6SL32 0-0 YC32- U U 0
30	40	104	104	80	80	98	FSE	6SL32 0-0 YC34- U U 0
37	50	130	130	104	104	126	FSF	6SL32 0-0 YC36- U U 0
45	60	154	154	130	130	149	FSF	6SL32 0-0 YC38- U U 0
55	75	192	192	154	154	172	FSF	6SL32 0-0 YC40- U U 0

#### Article No. supplements

Environmental class/harmful chemical substances acc. to IEC 60721-3-3: 2002

Class 3C2	2					
Class 3C3	3					
<b>Operator Panel</b>						
Without Operator Panel						
With BOP-2 Basic Operator Panel (numeric 2-line display)					1	
With IOP-2 Intelligent Operator Panel (graphic color display)					2	
					3	
<b>Extension with SINAMICS G120X I/O Extension Module</b>						
Without extension						0
With SINAMICS G120X I/O Extension Module						1
<b>Line filter</b>						
Without integrated line filter (for IT systems <sup>5)</sup> )						U
<b>Communication</b>						
USS, Modbus RTU, BACnet MS/TP						B
PROFINET, EtherNet/IP						F
PROFIBUS DP						P

<sup>1)</sup> Rated power based on the base-load current  $I_L$ . The base-load current  $I_L$  is based on the duty cycle for low overload (LO).

<sup>2)</sup> The rated output current is based on the duty cycle for low overload (LO). These current values are valid for 200 V or 240 V.

<sup>3)</sup> The base-load current  $I_L$  is based on the duty cycle for high overload (HO). These current values are valid for 200 V or 240 V.

<sup>4)</sup> The input current depends on the motor load and line impedance. The input currents apply for a load at rated power (based on  $I_L$ ) for a line impedance corresponding to  $u_K = 1\%$ . The current values are specified on the rating plate of the converter.

<sup>5)</sup> Non-filtered devices are designed for operation in IT systems or in conjunction with an RCD. The customer must provide suitable RI suppression equipment to ensure that these devices comply with the limits defined for Category C3.

Clicking to SiePortal

6SL3255-0AA00-5AA0



# SINAMICS G120X infrastructure converters for HVAC/Water/Wastewater

0.75 kW to 630 kW (1 hp to 700 hp)

## SINAMICS G120X infrastructure converters for HVAC/Water/Wastewater

**Line-side components** (Configuration with load-side power components see next double page)

Line filters		Line harmonics filters	Line reactors	Recommended line-side overcurrent protection devices <sup>1)</sup>			
Category C2	Category C1			Fuses IEC-compliant		Fuses UL/cUL-compliant	
Article No.	Article No.			Current A	Article No.	Rated voltage 600 V AC <sup>2)</sup>	Fuse type Class/Article No.
-	-	-	A DC line reactor is integrated for frame sizes FSA to FSF – therefore no line reactor is required.	16	<b>3NA3805</b>	J	15
-	-	-		16	<b>3NA3805</b>	J	15
-	-	-		16	<b>3NA3805</b>	J	15
-	-	-		32	<b>3NA3812</b>	J	35
-	-	-		32	<b>3NA3812</b>	J	35
-	-	-		32	<b>3NA3812</b>	J	35
-	-	-		50	<b>3NA3820</b>	J	50
-	-	-		50	<b>3NA3820</b>	J	50
-	-	-		63	<b>3NA3822</b>	J	60
-	-	-		80	<b>3NA3824</b>	J	70
-	-	-		100	<b>3NA3830</b>	J	90
-	-	-		100	<b>3NA3830</b>	J	110
-	-	-		160	<b>3NA3836</b>	J	150
-	-	-		200	<b>3NA3140</b>	J	175
-	-	-		200	<b>3NA3140</b>	J	200
-	-	-		224	<b>3NA3142</b>	J	250



<sup>1)</sup> Further information at <https://support.industry.siemens.com/cs/document/109762895>

<sup>2)</sup> The Short Circuit Current Rating (SCCR) according to UL for industrial control panel installations to NEC Article 409 or UL 508A/508C or UL 61800-5-1 is 100 kA for SINAMICS G120X.

# SINAMICS G120X infrastructure converters for HVAC/Water/Wastewater

0.75 kW to 630 kW (1 hp to 700 hp)

[Clicking to SiePortal](#)

6SL3255-0AA00-5AA0



## SINAMICS G120X infrastructure converters for HVAC/Water/Wastewater

### Selection and ordering data

SINAMICS G120X converters · Degree of protection IP20/UL Open Type · 200 ... 240 V 3 AC → Configuration with load-side power components (see right page)

Rated power <sup>1)</sup>		Rated output current <sup>2)</sup>		Base-load current $I_L$ <sup>3)</sup>		Rated input current <sup>4)</sup>	Frame size	SINAMICS G120X Degree of protection IP20/UL Open Type without integrated line filter
200 V kW	240 V hp	200 V A	240 V A	200 V A	240 V A	200 V A		Article No.
<b>200 ... 240 V 3 AC · Rated pulse frequency 4 kHz · Input frequency 47 ... 63 Hz</b>								
0.75	1	4.2	4.2	3.2	3.2	3.8	FSA	6SL32 0- YC10- U U 0
1.1	1.5	6	6	4.2	4.2	5.4	FSA	6SL32 0- YC12- U U 0
1.5	2	7.4	7.4	6	6	6.7	FSA	6SL32 0- YC14- U U 0
2.2	3	10.4	10.4	7.4	7.4	9.6	FSB	6SL32 0- YC16- U U 0
3	4	13.6	13.6	10.4	10.4	12.7	FSB	6SL32 0- YC18- U U 0
4	5	17.5	17.5	13.6	13.6	16.3	FSB	6SL32 0- YC20- U U 0
5.5	7.5	22	22	17.5	17.5	20.8	FSC	6SL32 0- YC22- U U 0
7.5	10	28	28	22	22	26.3	FSC	6SL32 0- YC24- U U 0
11	15	42	42	28	28	40	FSD	6SL32 0- YC26- U U 0
15	20	54	54	42	42	51	FSD	6SL32 0- YC28- U U 0
18.5	25	68	68	54	54	64	FSD	6SL32 0- YC30- U U 0
22	30	80	80	68	68	76	FSE	6SL32 0- YC32- U U 0
30	40	104	104	80	80	98	FSE	6SL32 0- YC34- U U 0
37	50	130	130	104	104	126	FSF	6SL32 0- YC36- U U 0
45	60	154	154	130	130	149	FSF	6SL32 0- YC38- U U 0
55	75	192	192	154	154	172	FSF	6SL32 0- YC40- U U 0

#### Article No. supplements

**Environmental class/harmful chemical substances** acc. to IEC 60721-3-3: 2002

Class 3C2

2

Class 3C3

3

#### Operator Panel

Without Operator Panel

1

With BOP-2 Basic Operator Panel (numeric 2-line display)

2

With IOP-2 Intelligent Operator Panel (graphic color display)

3

#### Extension with SINAMICS G120X I/O Extension Module

Without extension

0

With SINAMICS G120X I/O Extension Module

1

#### Line filter

Without integrated line filter (for IT systems <sup>5)</sup>)

U

#### Communication

USS, Modbus RTU, BACnet MS/TP

B

PROFINET, EtherNet/IP

F

PROFIBUS DP

P

<sup>1)</sup> Rated power based on the base-load current  $I_L$ . The base-load current  $I_L$  is based on the duty cycle for low overload (LO).

<sup>2)</sup> The rated output current is based on the duty cycle for low overload (LO). These current values are valid for 200 V or 240 V.

<sup>3)</sup> The base-load current  $I_L$  is based on the duty cycle for high overload (HO). These current values are valid for 200 V or 240 V.

<sup>4)</sup> The input current depends on the motor load and line impedance. The input currents apply for a load at rated power (based on  $I_L$ ) for a line impedance corresponding to  $u_K = 1\%$ . The current values are specified on the rating plate of the converter.

<sup>5)</sup> Non-filtered devices are designed for operation in IT systems or in conjunction with an RCD. The customer must provide suitable RI suppression equipment to ensure that these devices comply with the limits defined for Category C3.





# SINAMICS G120X infrastructure converters for HVAC/Water/Wastewater

0.75 kW to 630 kW (1 hp to 700 hp)

[Clicking to SiePortal](#)

6SL3255-0AA00-5AA0



## SINAMICS G120X infrastructure converters for HVAC/Water/Wastewater

### Selection and ordering data

SINAMICS G120X converters · Degree of protection IP20/UL Open Type · 380 ... 480 V 3 AC → Configuration with line-side components (see right page)

Rated power <sup>1)</sup>		Rated output current <sup>2)</sup>		Base-load current $I_L$ <sup>3)</sup>		Rated input current <sup>4)</sup>	Frame size	SINAMICS G120X Degree of protection IP20/UL Open Type without integrated line filter Converters up to 132 kW delivery ex stock	SINAMICS G120X Degree of protection IP20/UL Open Type with integrated line filter Converters up to 132 kW delivery ex stock
400 V kW	480 V hp	400 V A	480 V A	400 V A	480 V A	400 V A		10 ... 48 Article No. ↓↓	10 ... 48 Article No. ↓↓
<b>380 ... 480 V 3 AC · Rated pulse frequency 4 kHz ≤ 90 kW, 2 kHz for 110 kW to 250 kW and 4 kHz &gt; 250 kW · Input frequency 47 ... 63 Hz</b>									
0.75	1	2.2	2.1	1.7	1.6	2.1	FSA	6SL32 0- YE10- U 0	6SL32 0- YE10- A 0
1.1	1.5	3.1	3	2.2	2.1	2.8	FSA	6SL32 0- YE12- U 0	6SL32 0- YE12- A 0
1.5	2	4.1	3.4	3.1	3	3.6	FSA	6SL32 0- YE14- U 0	6SL32 0- YE14- A 0
2.2	3	5.9	4.8	4.1	3.4	5.5	FSA	6SL32 0- YE16- U 0	6SL32 0- YE16- A 0
3	4	7.7	6.2	5.9	4.8	6.9	FSA	6SL32 0- YE18- U 0	6SL32 0- YE18- A 0
4	5	10.2	7.6	7.7	6.2	9.8	FSB	6SL32 0- YE20- U 0	6SL32 0- YE20- A 0
5.5	7.5	13.2	11	10.2	7.6	12	FSB	6SL32 0- YE22- U 0	6SL32 0- YE22- A 0
7.5	10	18	14	13.2	11	17	FSB	6SL32 0- YE24- U 0	6SL32 0- YE24- A 0
11	15	26	21	18	14	24.5	FSC	6SL32 0- YE26- U 0	6SL32 0- YE26- A 0
15	20	32	27	26	21	29.5	FSC	6SL32 0- YE28- U 0	6SL32 0- YE28- A 0
18.5	25	38	34	32	27	36	FSD	6SL32 0- YE30- U 0	6SL32 0- YE30- A 0
22	30	45	40	38	34	42	FSD	6SL32 0- YE32- U 0	6SL32 0- YE32- A 0
30	40	60	52	45	40	57	FSD	6SL32 0- YE34- U 0	6SL32 0- YE34- A 0
37	50	75	65	60	52	70	FSD	6SL32 0- YE36- U 0	6SL32 0- YE36- A 0
45	60	90	77	75	65	86	FSE	6SL32 0- YE38- U 0	6SL32 0- YE38- A 0
55	75	110	96	90	77	104	FSE	6SL32 0- YE40- U 0	6SL32 0- YE40- A 0
75	100	145	124	110	96	140	FSF	6SL32 0- YE42- U 0	6SL32 0- YE42- A 0
90	125	178	156	145	124	172	FSF	6SL32 0- YE44- U 0	6SL32 0- YE44- A 0
110	150	205	180	178	156	198	FSF	6SL32 0- YE46- U 0	6SL32 0- YE46- A 0
132	200	250	240	205	180	242	FSF	6SL32 0- YE48- U 0	6SL32 0- YE48- A 0
160	250	302	302	250	240	301	FSG	-	6SL32 0- YE50- A 0
200	300	370	361	302	302	365	FSG	-	6SL32 0- YE52- A 0
250	400	477	477	370	361	471	FSG	-	6SL32 0- YE54- A 0
315	400	570	477	468	390	585	FSH	-	6SL32 2 0- YE56- C 0
355	450	640	515	491	394	654	FSH	-	6SL32 2 0- YE58- C 0
400	500	720	590	551	452	735	FSH	-	6SL32 2 0- YE60- C 0
450	500	820	663	672	542	850	FSJ	-	6SL32 2 0- YE62- C 0
500	600	890	724	728	591	924	FSJ	-	6SL32 2 0- YE64- C 0
560	700	1000	830	786	652	1038	FSJ	-	6SL32 2 0- YE66- C 0

#### Article No. supplements

Environmental class/harmful chemical substances acc. to IEC 60721-3-3: 2002									
Class 3C2 – <b>delivery ex stock</b>									
Class 3C3 *									
<b>Operator Panel</b>									
Without Operator Panel *									
With BOP-2 Basic Operator Panel (numeric 2-line display) *									
With IOP-2 Intelligent Operator Panel (graphic color display) – <b>delivery ex stock</b>									
<b>Extension with SINAMICS G120X I/O Extension Module</b>									
Without extension – <b>delivery ex stock</b>									
With SINAMICS G120X I/O Extension Module *									
<b>Line filter</b>									
Without integrated line filter (for IT systems <sup>5)</sup> ) – <b>delivery ex stock</b>									
With integrated line filter Category C2 – <b>delivery ex stock</b>									
With integrated line filter Category C3 *									
<b>Communication</b>									
USS, Modbus RTU, BACnet MS/TP *									
PROFINET, EtherNet/IP – <b>delivery ex stock</b>									
PROFIBUS DP *									

\* If you select one of these supplements, the delivery time for converters up to 132 kW will change from "delivery ex stock" to "standard delivery time".

- Rated power based on the base-load current  $I_L$ . The base-load current  $I_L$  is based on the duty cycle for low overload (LO).
- The rated output current is based on the duty cycle for low overload (LO). These current values are valid for 400 V or 480 V.
- The base-load current  $I_L$  is based on the duty cycle for high overload (HO). These current values are valid for 400 V or 480 V.
- The input current depends on the motor load and line impedance. The input currents apply for a load at rated power (based on  $I_L$ ) for a line impedance corresponding to  $u_k = 1\%$ . The current values are specified on the rating plate of the converter.
- Non-filtered devices are designed for operation in IT systems or in conjunction with an RCD. The customer must provide suitable RI suppression equipment to ensure that these devices comply with the limits defined for Category C3.

Clicking to SiePortal

6SL3255-0AA00-5AA0



# SINAMICS G120X infrastructure converters for HVAC/Water/Wastewater

0.75 kW to 630 kW (1 hp to 700 hp)

## SINAMICS G120X infrastructure converters for HVAC/Water/Wastewater

**Line-side components** (Configuration with load-side power components see next double page)

Line filters		Line harmonics filters <sup>1)</sup> (THD(I) < 5 %)  The prefix "UAC:" is part of a Siemens internal order code that does not belong to the product number of the original manufacturer Schaffner EMV AG.	Line reactors  For frame sizes FSH and FSJ mandatory when using an external line filter Category C2	Recommended line-side overcurrent protection devices <sup>4)</sup>			
Category C2	Category C1 Mandatory for • FSA to FSF ≤ 90 kW: Converter without integrated line filter • FSF 110 kW: Converter with integrated line filter			Fuses IEC-compliant		Fuses UL/cUL-compliant Rated voltage 600 V AC <sup>5)</sup>	
Article No.	Article No.		Article No.	Current A	Article No.	Fuse type Class/Article No.	Current A
SINAMICS G120X available with integrated line filter Category C2	6SL3203-0BE17-7BA1 <sup>6)</sup>	–	A DC line reactor is integrated for frame sizes FSA to FSG – therefore no line reactor is required.	16	3NA3805	J	15
		–		16	3NA3805	J	15
		–		16	3NA3805	J	15
		–		16	3NA3805	J	15
		–		16	3NA3805	J	15
	6SL3203-0BE21-8BA0 <sup>6)</sup>	–	32	3NA3812	J	35	
		UAC:FN34406112E2XXJRX	32	3NA3812	J	35	
		UAC:FN34408112E2XXJRX	32	3NA3812	J	35	
		6SL3203-0BE23-8BA0 <sup>6)</sup>	UAC:FN344011113E2FAJRX	50	3NA3820	J	50
			UAC:FN344015113E2FAJRX	50	3NA3820	J	50
		6SL3203-0BE23-8BA0	UAC:FN344019113E2FAJRX	63	3NA3822	J	60
			UAC:FN344022115E2FAJRX	80	3NA3824	J	70
		6SL3203-0BE27-5BA0	UAC:FN344030115E2FAJRX	100	3NA3830	J	90
			UAC:FN344037115E2FAJRX	100	3NA3830	J	100
		6SL3203-0BE31-1BA0	UAC:FN344045115E2FAJRX	125	3NA3832	J	125
			UAC:FN344055115E2FAJRX	160	3NA3836	J	150
		6SL3000-0BE31-2DA0	UAC:FN344075116E2FAJRX	200	3NA3140	J	200
			UAC:FN344090116E2FAJRX	224	3NA3142	J	250
		6SL3203-0BE31-8BA0	UAC:FN3440110118E2FAJRX	300	3NA3250	J	300
		–	UAC:FN3440132118E2FAJXX	315	3NA3252	J	350
–	UAC:FN3440160118E2FAJXX <sup>2)</sup>	355	3NA3254	J	400		
–	UAC:FN3440200118E2FAJXX <sup>2)</sup>	400	3NA3260	J	500		
–	UAC:FN3440132118E2FAJXX (2x) <sup>2) 3)</sup>	630	3NA3372	J	600		
6SL3760-0MR00-0AA0	–	6SL3000-0CE36-3AA0	710	3NE1437-2		710	
	–	6SL3000-0CE37-7AA0	800	3NE1438-2		800	
	–	–	850	3NE1448-2		850	
	–	6SL3000-0CE38-7AA0	1000	3NB3350-1KK26		1000	
	–	6SL3000-0CE41-0AA0	1100	3NB3351-1KK26		1100	
	–	–	1250	3NB3352-1KK26		1250	

<sup>1)</sup> Voltage 380 V to 415 V, frequency 50 Hz.

<sup>2)</sup> For 160 kW, 200 kW and 250 kW, only operation in Vector Control is permitted. V/f must not be used.

<sup>3)</sup> 250 kW with parallel connection of 2x 132 kW.

<sup>4)</sup> Further information at <https://support.industry.siemens.com/cs/document/109762895>

<sup>5)</sup> The Short Circuit Current Rating (SCCR) according to UL for industrial control panel installations to NEC Article 409 or UL 508A/508C or UL 61800-5-1 is 100 kA for SINAMICS G120X.

<sup>6)</sup> The line filters are suitable for base mounting for SINAMICS G120X frame sizes FSA to FSC. Further information especially to achieve EMC Category C1 is available in the documentation on the internet at: [www.siemens.com/sinamics-g120x/documentation](http://www.siemens.com/sinamics-g120x/documentation)

# SINAMICS G120X infrastructure converters for HVAC/Water/Wastewater

0.75 kW to 630 kW (1 hp to 700 hp)

[Clicking to SiePortal](#)

6SL3255-0AA00-5AA0



## SINAMICS G120X infrastructure converters for HVAC/Water/Wastewater

### Selection and ordering data

SINAMICS G120X converters · Degree of protection IP20/UL Open Type · 380 ... 480 V 3 AC ⇒ Configuration with load-side power components (see right page)

Rated power <sup>1)</sup>		Rated output current <sup>2)</sup>		Base-load current $I_L$ <sup>3)</sup>		Rated input current <sup>4)</sup>	Frame size	SINAMICS G120X Degree of protection IP20/UL Open Type without integrated line filter Converters up to 132 kW delivery ex stock	SINAMICS G120X Degree of protection IP20/UL Open Type with integrated line filter Converters up to 132 kW delivery ex stock
400 V kW	480 V hp	400 V A	480 V A	400 V A	480 V A	400 V A		10 ... 48 ↓ ↓	10 ... 48 ↓ ↓
								Article No.	Article No.

380 ... 480 V 3 AC · Rated pulse frequency 4 kHz ≤ 90 kW, 2 kHz for 110 kW to 250 kW and 4 kHz > 250 kW · Input frequency 47 ... 63 Hz

0.75	1	2.2	2.1	1.7	1.6	2.1	FSA	6SL32	0-0-YE10-U	0	6SL32	0-0-YE10-A	0
1.1	1.5	3.1	3	2.2	2.1	2.8	FSA	6SL32	0-0-YE12-U	0	6SL32	0-0-YE12-A	0
1.5	2	4.1	3.4	3.1	3	3.6	FSA	6SL32	0-0-YE14-U	0	6SL32	0-0-YE14-A	0
2.2	3	5.9	4.8	4.1	3.4	5.5	FSA	6SL32	0-0-YE16-U	0	6SL32	0-0-YE16-A	0
3	4	7.7	6.2	5.9	4.8	6.9	FSA	6SL32	0-0-YE18-U	0	6SL32	0-0-YE18-A	0
4	5	10.2	7.6	7.7	6.2	9.8	FSB	6SL32	0-0-YE20-U	0	6SL32	0-0-YE20-A	0
5.5	7.5	13.2	11	10.2	7.6	12	FSB	6SL32	0-0-YE22-U	0	6SL32	0-0-YE22-A	0
7.5	10	18	14	13.2	11	17	FSB	6SL32	0-0-YE24-U	0	6SL32	0-0-YE24-A	0
11	15	26	21	18	14	24.5	FSC	6SL32	0-0-YE26-U	0	6SL32	0-0-YE26-A	0
15	20	32	27	26	21	29.5	FSC	6SL32	0-0-YE28-U	0	6SL32	0-0-YE28-A	0
18.5	25	38	34	32	27	36	FSD	6SL32	0-0-YE30-U	0	6SL32	0-0-YE30-A	0
22	30	45	40	38	34	42	FSD	6SL32	0-0-YE32-U	0	6SL32	0-0-YE32-A	0
30	40	60	52	45	40	57	FSD	6SL32	0-0-YE34-U	0	6SL32	0-0-YE34-A	0
37	50	75	65	60	52	70	FSD	6SL32	0-0-YE36-U	0	6SL32	0-0-YE36-A	0
45	60	90	77	75	65	86	FSE	6SL32	0-0-YE38-U	0	6SL32	0-0-YE38-A	0
55	75	110	96	90	77	104	FSE	6SL32	0-0-YE40-U	0	6SL32	0-0-YE40-A	0
75	100	145	124	110	96	140	FSF	6SL32	0-0-YE42-U	0	6SL32	0-0-YE42-A	0
90	125	178	156	145	124	172	FSF	6SL32	0-0-YE44-U	0	6SL32	0-0-YE44-A	0
110	150	205	180	178	156	198	FSF	6SL32	0-0-YE46-U	0	6SL32	0-0-YE46-A	0
132	200	250	240	205	180	242	FSF	6SL32	0-0-YE48-U	0	6SL32	0-0-YE48-A	0
160	250	302	302	250	240	301	FSG	-			6SL32	0-0-YE50-	0
200	300	370	361	302	302	365	FSG	-			6SL32	0-0-YE52-	0
250	400	477	477	370	361	471	FSG	-			6SL32	0-0-YE54-	0
315	400	570	477	468	390	585	FSH	-			6SL32	2 0-0-YE56-	C 0
355	450	640	515	491	394	654	FSH	-			6SL32	2 0-0-YE58-	C 0
400	500	720	590	551	452	735	FSH	-			6SL32	2 0-0-YE60-	C 0
450	500	820	663	672	542	850	FSJ	-			6SL32	2 0-0-YE62-	C 0
500	600	890	724	728	591	924	FSJ	-			6SL32	2 0-0-YE64-	C 0
560	700	1000	830	786	652	1038	FSJ	-			6SL32	2 0-0-YE66-	C 0

#### Article No. supplements

Environmental class/harmful chemical substances acc. to IEC 60721-3-3: 2002

Class 3C2 – **delivery ex stock**

Class 3C3 \*

#### Operator Panel

Without Operator Panel \*

With BOP-2 Basic Operator Panel (numeric 2-line display) \*

With IOP-2 Intelligent Operator Panel (graphic color display) – **delivery ex stock**

#### Extension with SINAMICS G120X I/O Extension Module

Without extension – **delivery ex stock**

With SINAMICS G120X I/O Extension Module \*

#### Line filter

Without integrated line filter (for IT systems <sup>5)</sup>) – **delivery ex stock**

With integrated line filter Category C2 – **delivery ex stock**

With integrated line filter Category C3 \*

#### Communication

USS, Modbus RTU, BACnet MS/TP \*

PROFINET, EtherNet/IP – **delivery ex stock**

PROFIBUS DP \*

\* If you select one of these supplements, the delivery time for converters up to 132 kW will change from "delivery ex stock" to "standard delivery time".

<sup>1)</sup> Rated power based on the base-load current  $I_L$ . The base-load current  $I_L$  is based on the duty cycle for low overload (LO).

<sup>2)</sup> The rated output current is based on the duty cycle for low overload (LO). These current values are valid for 400 V or 480 V.

<sup>3)</sup> The base-load current  $I_L$  is based on the duty cycle for high overload (HO). These current values are valid for 400 V or 480 V.

<sup>4)</sup> The input current depends on the motor load and line impedance. The input currents apply for a load at rated power (based on  $I_L$ ) for a line impedance corresponding to  $u_k = 1\%$ . The current values are specified on the rating plate of the converter.

<sup>5)</sup> Non-filtered devices are designed for operation in IT systems or in conjunction with an RCD. The customer must provide suitable RI suppression equipment to ensure that these devices comply with the limits defined for Category C3.

Clicking to SiePortal

6SL3255-0AA00-5AA0



# SINAMICS G120X infrastructure converters for HVAC/Water/Wastewater

0.75 kW to 630 kW (1 hp to 700 hp)

## SINAMICS G120X infrastructure converters for HVAC/Water/Wastewater

### Load-side power components (Configuration with line-side components see double page before)

Output reactors	Sine-wave filters When using sine-wave filters, please note for the pulse frequency of the converter: • ≤ 90 kW: 4 kHz up to 8 kHz • ≥ 110 kW: 4 kHz	dv/dt filters plus VPL The prefix "JTA:" is part of a Siemens internal order code that does not belong to the product number of the original manufacturer Mdexx Magnetronic Devices s. r. o..
Article No.	Article No.	Article No.
-	6SL3202-0AE20-3SA0	-
-	6SL3202-0AE20-6SA0	-
-	-	-
-	6SL3202-0AE21-1SA0	-
-	-	-
-	6SL3202-0AE21-4SA0	-
-	6SL3202-0AE22-0SA0	-
-	-	-
-	6SL3202-0AE23-3SA0	-
-	-	-
6SL3202-0AE23-8CA0	6SL3202-0AE24-6SA0	JTA:TEF1203-0HB
6SE6400-3TC07-5ED0	-	JTA:TEF1203-0JB
-	6SL3202-0AE26-2SA0	-
-	6SL3202-0AE28-8SA0	JTA:TEF1203-0KB
6SE6400-3TC14-5FD0	-	-
-	6SL3202-0AE31-5SA0	JTA:TEF1203-0LB
-	-	-
-	6SL3202-0AE31-8SA0	JTA:TEF1203-0MB
6SL3000-2BE32-1AA0	6SL3000-2CE32-3AA0 <sup>1)</sup>	-
6SL3000-2BE32-6AA0	-	-
6SL3000-2BE33-2AA0	6SL3000-2CE32-8AA0 <sup>1)2)</sup>	6SL3000-2DE35-0AA0
6SL3000-2BE33-8AA0	6SL3000-2CE33-3AA0 <sup>1)2)</sup>	-
6SL3000-2BE35-0AA0	6SL3000-2CE34-1AA0 <sup>1)2)</sup>	-
6SL3000-2AE36-1AA0	-	6SL3000-2DE38-4AA0
6SL3000-2AE38-4AA0	-	-
-	-	-
6SL3000-2AE41-0AA0	-	6SL3000-2DE41-4AA0
-	-	-
6SL3000-2AE41-4AA0	-	-

### Ordering examples

Basic selection	Example 1	Example 2
SINAMICS G120X converters · degree of protection IP20/UL Open Type · 380 ... 480 V 3 AC, 15 kW · with integrated line filter – <b>converters up to 132 kW delivery ex stock</b>	6SL32 0-0- YE28- A 0 0	6SL32 0-0- YE28- A 0 0

### Article No. supplements

<b>Environmental class/harmful chemical substances</b> acc. to IEC 60721-3-3: 2002	
Class 3C2 – <b>delivery ex stock</b>	
Class 3C3 *	
<b>Operator Panel</b>	
With BOP-2 Basic Operator Panel (numeric 2-line display) *	
With IOP-2 Intelligent Operator Panel (graphic color display) – <b>delivery ex stock</b>	
<b>Extension with SINAMICS G120X I/O Extension Module</b>	
Without extension – <b>delivery ex stock</b>	
With SINAMICS G120X I/O Extension Module *	
<b>Line filter</b>	
With integrated line filter Category C2 – <b>delivery ex stock</b>	
<b>Communication</b>	
USS, Modbus RTU, BACnet MS/TP *	
PROFINET, EtherNet/IP – <b>delivery ex stock</b>	
PROFIBUS DP *	
<b>Complete Article No.</b>	6SL32 2 0-3 YE28- 0 A F 0
	<b>Delivery ex stock</b>
	6SL32 3 0-2 YE28- 0 A F 0
	<b>Standard delivery time</b>

\* If you select one of these supplements, the delivery time for converters up to 132 kW will change from "delivery ex stock" to "standard delivery time".

<sup>1)</sup> For converters with a rated power ≥ 110 kW, around 70 % of the current and power is still available when using sine-wave filters due to current derating of the converter.

<sup>2)</sup> For 160 kW, 200 kW and 250 kW, only operation in Vector Control is permitted. V/f must not be used.





# SINAMICS G120X infrastructure converters for HVAC/Water/Wastewater

0.75 kW to 630 kW (1 hp to 700 hp)

[Clicking to SiePortal](#)

6SL3255-0AA00-5AA0



## SINAMICS G120X infrastructure converters for HVAC/Water/Wastewater

### Selection and ordering data

SINAMICS G120X converters · Degree of protection IP20/UL Open Type · 500 ... 690 V 3 AC ⇒ Configuration with line-side components (see right page)

Rated power <sup>1)</sup>		Rated output current <sup>2)</sup>		Base-load current $I_H$ <sup>3)</sup>		Rated input current <sup>4)</sup>	Frame size	SINAMICS G120X Degree of protection IP20/UL Open Type without integrated line filter	SINAMICS G120X Degree of protection IP20/UL Open Type with integrated line filter
690 V kW	600 V hp	690 V A	600 V A	690 V A	600 V A	690 V A		Article No.	Article No.
<b>500 ... 690 V 3 AC · Rated pulse frequency 2 kHz · Input frequency 47 ... 63 Hz</b>									
3	4	5	5	4	4	5	FSD	6SL32 0- YH18- U 0	6SL32 0- YH18- A 0
4	5	6.3	6.3	5	5	6	FSD	6SL32 0- YH20- U 0	6SL32 0- YH20- A 0
5.5	7.5	9	9	6.3	6.3	9	FSD	6SL32 0- YH22- U 0	6SL32 0- YH22- A 0
7.5	10	11	11	9	9	11	FSD	6SL32 0- YH24- U 0	6SL32 0- YH24- A 0
11	10	14	14	11	11	14	FSD	6SL32 0- YH26- U 0	6SL32 0- YH26- A 0
15	15	19	19	14	14	18	FSD	6SL32 0- YH28- U 0	6SL32 0- YH28- A 0
18.5	20	23	23	19	19	22	FSD	6SL32 0- YH30- U 0	6SL32 0- YH30- A 0
22	25	27	27	23	23	25	FSD	6SL32 0- YH32- U 0	6SL32 0- YH32- A 0
30	30	35	35	27	27	33	FSD	6SL32 0- YH34- U 0	6SL32 0- YH34- A 0
37	40	42	42	35	35	40	FSD	6SL32 0- YH36- U 0	6SL32 0- YH36- A 0
45	50	52	52	42	42	50	FSE	6SL32 0- YH38- U 0	6SL32 0- YH38- A 0
55	60	62	62	52	52	59	FSE	6SL32 0- YH40- U 0	6SL32 0- YH40- A 0
75	75	80	80	62	62	78	FSF	6SL32 0- YH42- U 0	6SL32 0- YH42- C 0
90	100	100	100	80	80	97	FSF	6SL32 0- YH44- U 0	6SL32 0- YH44- C 0
110	125	125	125	100	100	121	FSF	6SL32 0- YH46- U 0	6SL32 0- YH46- C 0
132	150	144	144	125	125	138	FSF	6SL32 0- YH48- U 0	6SL32 0- YH48- C 0
160	150	171	171	144	144	171	FSG <sup>5)</sup>	-	6SL32 0- YH50- C 0
200	200	208	208	171	171	205	FSG <sup>5)</sup>	-	6SL32 0- YH52- C 0
250	250	250	250	208	208	249	FSG <sup>5)</sup>	-	6SL32 0- YH54- C 0
315	350	330	345	272	282	343	FSH	-	6SL32 2 0- YH56- C 0
355	400	385	388	314	317	401	FSH	-	6SL32 2 0- YH58- C 0
400	450	420	432	348	357	437	FSH	-	6SL32 2 0- YH60- C 0
450	500	470	487	394	408	489	FSH	-	6SL32 2 0- YH62- C 0
500	500	520	546	444	462	540	FSJ	-	6SL32 2 0- YH64- C 0
560	600	580	610	476	498	602	FSJ	-	6SL32 2 0- YH66- C 0
630	700	650	679	532	554	675	FSJ	-	6SL32 2 0- YH68- C 0

#### Article No. supplements

<b>Environmental class/harmful chemical substances</b> acc. to IEC 60721-3-3: 2002									
Class 3C2								2	
Class 3C3								3	
<b>Operator Panel</b>									
Without Operator Panel									1
With BOP-2 Basic Operator Panel (numeric 2-line display)									2
With IOP-2 Intelligent Operator Panel (graphic color display)									3
<b>Extension with SINAMICS G120X I/O Extension Module</b>									
Without extension									0
With SINAMICS G120X I/O Extension Module									1
<b>Line filter</b>									
Without integrated line filter (for IT systems <sup>6)</sup> )									U
With integrated line filter Category C2									A
With integrated line filter Category C3									C
<b>Communication</b>									
USS, Modbus RTU, BACnet MS/TP									B
PROFINET, EtherNet/IP									F
PROFIBUS DP									P

<sup>1)</sup> Rated power based on the base-load current  $I_L$ . The base-load current  $I_L$  is based on the duty cycle for low overload (LO).  
<sup>2)</sup> The rated output current is based on the duty cycle for low overload (LO). These current values are valid for 690 V or 600 V.  
<sup>3)</sup> The base-load current  $I_H$  is based on the duty cycle for high overload (HO). These current values are valid for 690 V or 600 V.  
<sup>4)</sup> The input current depends on the motor load and line impedance. The input currents apply for a load at rated power (based on  $I_L$ ) for a line impedance corresponding to  $u_K = 1\%$ . The current values are specified on the rating plate of the converter.

<sup>5)</sup> The 690 V versions of frame size FSG are only available with an integrated line filter Category C3. To operate the converters also within TN systems with grounded outer conductor, you must remove the grounding screw.  
<sup>6)</sup> Non-filtered devices are designed for operation in IT systems or in conjunction with an RCD. The customer must provide suitable RI suppression equipment to ensure that these devices comply with the limits defined for Category C3.

Clicking to SiePortal

6SL3255-0AA00-5AA0



# SINAMICS G120X infrastructure converters for HVAC/Water/Wastewater

0.75 kW to 630 kW (1 hp to 700 hp)

## SINAMICS G120X infrastructure converters for HVAC/Water/Wastewater

**Line-side components** (Configuration with load-side power components see next double page)

Line filters		Line reactors	Recommended line-side overcurrent protection devices <sup>1)</sup>			
Category C2	Category C1	For frame sizes FSH and FSJ mandatory when using an external line filter Category C2	Fuses IEC-compliant		Fuses UL/cUL-compliant Rated voltage 600 V AC <sup>2)</sup>	
	Article No.	Article No.	Current A	Article No.	Fuse type Class/Article No.	Current A
SINAMICS G120X available with integrated line filter Category C2	-	A DC link reactor is integrated for frame sizes FSA to FSG – therefore no line reactor is required.	16	<b>3NA3805-6</b>	J	8
	-		16	<b>3NA3805-6</b>	J	10
	-		16	<b>3NA3805-6</b>	J	15
	-		16	<b>3NA3805-6</b>	J	15
	-		20	<b>3NA3807-6</b>	J	20
	-		25	<b>3NA3810-6</b>	J	25
	-		32	<b>3NA3812-6</b>	J	30
	-		40	<b>3NA3817-6KJ</b>	J	35
	-		50	<b>3NA3820-6KJ</b>	J	50
	-		63	<b>3NA3822-6</b>	J	60
	-		80	<b>3NA3824-6</b>	J	80
	-		80	<b>3NA3824-6</b>	J	80
	-		100	<b>3NA3830-6</b>	J	110
	-		125	<b>3NA3132-6</b>	J	150
	-		160	<b>3NA3136-6</b>	J	150
	-		200	<b>3NA3140-6</b>	J	200
-		250	<b>3NE1227-0</b>		250	
-		315	<b>3NE1230-0</b>		315	
-		350	<b>3NE1331-0</b>		350	
<b>6SL3760-0MS00-0AA0</b>	-	<b>6SL3000-0CH34-8AA0</b>	450	<b>3NE1333-2</b>		450
	-		500	<b>3NE1334-2</b>		500
	-		560	<b>3NE1435-2</b>		560
	-	<b>6SL3000-0CH36-0AA0</b>	630	<b>3NE1436-2</b>		630
	-		710	<b>3NE1437-2</b>		710
	-	<b>6SL3000-0CH38-4AA0</b>	800	<b>3NE1438-2</b>		800
	-		850	<b>3NE1448-2</b>		850



<sup>1)</sup> Further information at <https://support.industry.siemens.com/cs/document/109762895>

<sup>2)</sup> The Short Circuit Current Rating (SCCR) according to UL for industrial control panel installations to NEC Article 409 or UL 508A/508C or UL 61800-5-1 is 100 kA for SINAMICS G120X.

# SINAMICS G120X infrastructure converters for HVAC/Water/Wastewater

0.75 kW to 630 kW (1 hp to 700 hp)

[Clicking to SiePortal](#)

6SL3255-0AA00-5AA0



## SINAMICS G120X infrastructure converters for HVAC/Water/Wastewater

### Selection and ordering data

SINAMICS G120X converters · Degree of protection IP20/UL Open Type · 500 ... 690 V 3 AC ⇒ Configuration with load-side power components (see right page)

Rated power <sup>1)</sup>		Rated output current <sup>2)</sup>		Base-load current $I_H$ <sup>3)</sup>		Rated input current <sup>4)</sup>	Frame size	SINAMICS G120X Degree of protection IP20/UL Open Type without integrated line filter	SINAMICS G120X Degree of protection IP20/UL Open Type with integrated line filter
690 V kW	600 V hp	690 V A	600 V A	690 V A	600 V A	690 V A		Article No.	Article No.
<b>500 ... 690 V 3 AC · Rated pulse frequency 2 kHz · Input frequency 47 ... 63 Hz</b>									
3	4	5	5	4	4	5	FSD	6SL32 0- YH18- U 0	6SL32 0- YH18- A 0
4	5	6.3	6.3	5	5	6	FSD	6SL32 0- YH20- U 0	6SL32 0- YH20- A 0
5.5	7.5	9	9	6.3	6.3	9	FSD	6SL32 0- YH22- U 0	6SL32 0- YH22- A 0
7.5	10	11	11	9	9	11	FSD	6SL32 0- YH24- U 0	6SL32 0- YH24- A 0
11	10	14	14	11	11	14	FSD	6SL32 0- YH26- U 0	6SL32 0- YH26- A 0
15	15	19	19	14	14	18	FSD	6SL32 0- YH28- U 0	6SL32 0- YH28- A 0
18.5	20	23	23	19	19	22	FSD	6SL32 0- YH30- U 0	6SL32 0- YH30- A 0
22	25	27	27	23	23	25	FSD	6SL32 0- YH32- U 0	6SL32 0- YH32- A 0
30	30	35	35	27	27	33	FSD	6SL32 0- YH34- U 0	6SL32 0- YH34- A 0
37	40	42	42	35	35	40	FSD	6SL32 0- YH36- U 0	6SL32 0- YH36- A 0
45	50	52	52	42	42	50	FSE	6SL32 0- YH38- U 0	6SL32 0- YH38- A 0
55	60	62	62	52	52	59	FSE	6SL32 0- YH40- U 0	6SL32 0- YH40- A 0
75	75	80	80	62	62	78	FSF	6SL32 0- YH42- U 0	6SL32 0- YH42- C 0
90	100	100	100	80	80	97	FSF	6SL32 0- YH44- U 0	6SL32 0- YH44- C 0
110	125	125	125	100	100	121	FSF	6SL32 0- YH46- U 0	6SL32 0- YH46- C 0
132	150	144	144	125	125	138	FSF	6SL32 0- YH48- U 0	6SL32 0- YH48- C 0
160	150	171	171	144	144	171	FSG <sup>5)</sup>	-	6SL32 0- YH50- C 0
200	200	208	208	171	171	205	FSG <sup>5)</sup>	-	6SL32 0- YH52- C 0
250	250	250	250	208	208	249	FSG <sup>5)</sup>	-	6SL32 0- YH54- C 0
315	350	330	345	272	282	343	FSH	-	6SL32 2 0- YH56- C 0
355	400	385	388	314	317	401	FSH	-	6SL32 2 0- YH58- C 0
400	450	420	432	348	357	437	FSH	-	6SL32 2 0- YH60- C 0
450	500	470	487	394	408	489	FSH	-	6SL32 2 0- YH62- C 0
500	500	520	546	444	462	540	FSJ	-	6SL32 2 0- YH64- C 0
560	600	580	610	476	498	602	FSJ	-	6SL32 2 0- YH66- C 0
630	700	650	679	532	554	675	FSJ	-	6SL32 2 0- YH68- C 0

#### Article No. supplements

<b>Environmental class/harmful chemical substances</b> acc. to IEC 60721-3-3: 2002	2								
Class 3C2									
Class 3C3	3								
<b>Operator Panel</b>									
Without Operator Panel									
With BOP-2 Basic Operator Panel (numeric 2-line display)	1								
With IOP-2 Intelligent Operator Panel (graphic color display)	2								
	3								
<b>Extension with SINAMICS G120X I/O Extension Module</b>									
Without extension						0			
With SINAMICS G120X I/O Extension Module						1			
<b>Line filter</b>									
Without integrated line filter (for IT systems <sup>6)</sup> )							U		
With integrated line filter Category C2									A
With integrated line filter Category C3									C
<b>Communication</b>									
USS, Modbus RTU, BACnet MS/TP							B		B
PROFINET, EtherNet/IP							F		F
PROFIBUS DP							P		P

1) Rated power based on the base-load current  $I_L$ . The base-load current  $I_L$  is based on the duty cycle for low overload (LO).  
 2) The rated output current is based on the duty cycle for low overload (LO). These current values are valid for 690 V or 600 V.  
 3) The base-load current  $I_H$  is based on the duty cycle for high overload (HO). These current values are valid for 690 V or 600 V.  
 4) The input current depends on the motor load and line impedance. The input currents apply for a load at rated power (based on  $I_L$ ) for a line impedance corresponding to  $u_K = 1\%$ . The current values are specified on the rating plate of the converter.

5) The 690 V versions of frame size FSG are only available with an integrated line filter Category C3. To operate the converters also within TN systems with grounded outer conductor, you must remove the grounding screw.  
 6) Non-filtered devices are designed for operation in IT systems or in conjunction with an RCD. The customer must provide suitable RI suppression equipment to ensure that these devices comply with the limits defined for Category C3.

Clicking to SiePortal

6SL3255-0AA00-5AA0



# SINAMICS G120X infrastructure converters for HVAC/Water/Wastewater

0.75 kW to 630 kW (1 hp to 700 hp)

## SINAMICS G120X infrastructure converters for HVAC/Water/Wastewater

### Load-side power components (Configuration with line-side components see double page before)

<b>Output reactors</b> The prefix "JTA:" is part of a Siemens internal order code that does not belong to the product number of the original manufacturer Mdexx Magnetronic Devices s. r. o..  Article No.	<b>Sine-wave filters</b>   Article No.	<b>dv/dt filters plus VPL</b> The prefix "JTA:" is part of a Siemens internal order code that does not belong to the product number of the original manufacturer Mdexx Magnetronic Devices s. r. o..  Article No.	
JTA:TEU2532-0FP00-4EA0	-	JTA:TEF1203-0GB	
	-		
	-		
	-		
	-		
	-		
	-		
JTA:TEU9932-0FP00-4EA0	-	JTA:TEF1203-0HB	
	-		
	-		
JTA:TEU9932-0FS00-0EA0	-	JTA:TEF1203-0JB	
	-		
JTA:TEU9932-1FC00-1BA0	-	JTA:TEF1203-0KB	
	-		
JTA:TEU9932-0FV00-1BA0	-	JTA:TEF1203-0LB	
	-		
JTA:TEU4732-0FA00-0BA0	-	JTA:TEF1203-0MB	
	-		
	-		
6SL3000-2AH34-7AA0	-	6SL3000-2DH35-8AA0	
	-		
6SL3000-2AH35-8AA0	-		
6SL3000-2AH38-1AA0	-	6SL3000-2DH38-1AA0	
	-		
	-		
	-		





# SINAMICS G120X infrastructure converters for HVAC/Water/Wastewater

0.75 kW to 630 kW (1 hp to 700 hp)

[Clicking to SiePortal](#)
[6SL3255-0AA00-5AA0](#)

## SINAMICS G120X infrastructure converters for HVAC/Water/Wastewater

### Selection and ordering data

#### Supplementary system components for SINAMICS G120X

Description	Article No.
<b>IOP-2 Intelligent Operator Panel</b> Operating languages: English, German, French, Italian, Spanish, Portuguese, Dutch, Swedish, Finnish, Russian, Czech, Polish, Turkish, Chinese Simplified	<b>6SL3255-0AA00-4JA2</b>
<b>IOP-2 Handheld</b>	<b>6SL3255-0AA00-4HA1</b>
<b>BOP-2 Basic Operator Panel</b>	<b>6SL3255-0AA00-4CA1</b>
<b>Door mounting kit</b> for IOP-2/BOP-2	<b>6SL3256-0AP00-0JA0</b>
<b>SINAMICS SD card</b> 512 MB, empty	<b>6SL3054-4AG00-2AA0</b>
<b>SINAMICS G120 Smart Access</b> for wireless commissioning, operation and diagnostics of the following converters using a smartphone, tablet or laptop	<b>6SL3255-0AA00-5AA0</b>
<b>SINAMICS G120X I/O Extension Module</b> for direct connection of Pt1000/Ni1000 temperature sensors <sup>1)</sup>	<b>6SL3255-0BE00-0AA0</b>
<b>Shield connection kits for Power Module</b> for SINAMICS G120X • Frame sizes FSA to FSG  • Frame sizes FSH to FSJ	Included in the scope of delivery of the converters, can be ordered as spare part Please observe the notes included in the operating instructions
<b>Push-through mounting frames</b> for SINAMICS G120X • Frame size FSA • Frame size FSB • Frame size FSC • Frame size FSD • Frame size FSE • Frame size FSF • Frame size FSG	<b>6SL3261-6GA00-0BA0</b> <b>6SL3261-6GB00-0BA0</b> <b>6SL3261-6GC00-0BA0</b> <b>6SL3261-6GD00-0BA0</b> <b>6SL3261-6GE00-0BA0</b> <b>6SL3261-6GF00-0BA0</b> <b>6SL3261-6GG00-0BA0</b>
<b>Installation handles</b> for SINAMICS G120X • Frame sizes FSD to FSF	<b>6SL3200-0SM22-0AA0</b>
<b>IP21 top covers</b> for SINAMICS G120X • Frame size FSA • Frame size FSB • Frame sizes FSC and FSD • Frame size FSE • Frame sizes FSF and FSG	<b>6SL3266-1PA00-0BA0</b> <b>6SL3266-1PB00-0BA0</b> <b>6SL3266-1PD00-0BA0</b> <b>6SL3266-1PE00-0BA0</b> <b>6SL3266-1PF00-0BA0</b>
<b>Wiring adapter</b> for optimal and space-saving wiring for SINAMICS G120X • Frame size FSG	<b>6SL3266-2HG00-0BA0</b>
<b>Installation kit for line-side cable connection, left</b> for SINAMICS G120X • Frame size FSH	<b>6SL3366-1LH00-0PA0</b>
<b>SINAMICS G120X Starter Kits</b> Converter (380 ... 480 V 3 AC, PROFINET) with IOP-2 and SINAMICS G120 Smart Access • 0.75 kW, FSA, without integrated line filter • 0.75 kW, FSA, with integrated line filter Category C2 • 3 kW, FSA, with integrated line filter Category C2 • 7.5 kW, FSB, with integrated line filter Category C2	<b>6SL3200-0AE70-0AA0</b> <b>6SL3200-0AE72-0AA0</b> <b>6SL3200-0AE73-0AA0</b> <b>6SL3200-0AE74-0AA0</b>
<b>SINAMICS G120X training case</b>	<b>6AG1067-2AA00-0AC1</b>

#### Spare parts for SINAMICS G120X

Description	Article No.
<b>FPI board (freely-programmable interface board)</b> for SINAMICS G120X • Frame sizes FSH and FSJ	<b>6SL3200-0SP05-0AA0</b>
<b>PSB board (power supply board)</b> for SINAMICS G120X • Frame sizes FSH and FSJ	<b>6SL3200-0SP06-0AA0</b>
<b>Current transformers</b> for SINAMICS G120X • 2000 A for frame size FSJ • 1000 A for frame sizes FSH and FSJ	<b>6SL3200-0SE01-0AA0</b> <b>6SL3200-0SE02-0AA0</b>
<b>Spare parts kit for Control Unit</b> for SINAMICS G120X • Frame sizes FSA to FSJ	<b>6SL3200-0SK10-0AA0</b>
<b>Shield connection kit for Control Unit</b> for SINAMICS G120X • Frame sizes FSD to FSG	<b>6SL3264-1EA00-0YA0</b>
<b>Shield connection kits for Power Module</b> for SINAMICS G120X • Frame size FSA • Frame size FSB • Frame size FSC • Frame size FSD • Frame size FSE • Frame size FSF • Frame size FSG	<b>6SL3262-1AA01-0DA0</b> <b>6SL3262-1AB01-0DA0</b> <b>6SL3262-1AC01-0DA0</b> <b>6SL3262-1AD01-0DA0</b> <b>6SL3262-1AE01-0DA0</b> <b>6SL3262-1AF01-0DA0</b> <b>6SL3262-1AG01-0DA0</b>
<b>Small parts assembly set</b> for SINAMICS G120X • Frame sizes FSD to FSG	<b>6SL3200-0SK08-0AA0</b>
<b>Terminal cover kits</b> for SINAMICS G120X • Frame size FSD • Frame size FSE • Frame size FSF • Frame size FSG	<b>6SL3200-0SM13-0AA0</b> <b>6SL3200-0SM14-0AA0</b> <b>6SL3200-0SM15-0AA0</b> <b>6SL3200-0SM16-0AA0</b>
<b>External fan units</b> for SINAMICS G120X • Frame size FSA • Frame size FSB • Frame size FSC • Frame size FSD • Frame size FSE • Frame size FSF • Frame size FSG • Frame sizes FSH and FSJ	<b>6SL3200-0SF52-0AA0</b> <b>6SL3200-0SF53-0AA0</b> <b>6SL3200-0SF54-0AA0</b> <b>6SL3200-0SF15-0AA0</b> <b>6SL3200-0SF16-0AA0</b> <b>6SL3200-0SF17-0AA0</b> <b>6SL3200-0SF18-0AA0</b> <b>6SL3300-0SF01-0AA0</b>
<b>Internal fan unit</b> for SINAMICS G120X • Frame sizes FSH and FSJ	<b>6SL3200-0SF50-0AA0</b>
<b>Control Units</b> for SINAMICS G120X frame sizes FSD to FSJ • USS, Modbus RTU, BACnet MS/TP • PROFINET, EtherNet/IP • PROFIBUS DP	<b>6SL3200-0SC10-0BA0</b> <b>6SL3200-0SC10-0FA0</b> <b>6SL3200-0SC10-0PA0</b>

Further technical specifications and documentation are available on the internet at:

[www.siemens.com/sinamics-g120x/documentation](http://www.siemens.com/sinamics-g120x/documentation)

and via the Siemens Product Configurator in SiePortal:

[www.siemens.com/spc](http://www.siemens.com/spc)

<sup>1)</sup> The SINAMICS G120X I/O Extension Module (article number: 6SL3255-0BE00-0AA0) is only supported on the SINAMICS G120X converters with hardware version  $\geq$  02 02 (FSA to FSG) / 02 (FSH/FSJ) and firmware  $\geq$  V1.01.  
The hardware version of the converter is on the rating plate.  
For more information please refer to the documentation on the internet at: [www.siemens.com/sinamics-g120x/documentation](http://www.siemens.com/sinamics-g120x/documentation)

# SINAMICS G120X infrastructure converters for HVAC/Water/Wastewater

0.75 kW to 630 kW (1 hp to 700 hp)

## SINAMICS G120X infrastructure converters for HVAC/Water/Wastewater

### Technical specifications

Unless explicitly specified otherwise, the following technical specifications are valid for all SINAMICS G120X converters.

General technical specifications	
<b>Mechanical specifications</b>	
<b>Shock and vibration load</b>	
<ul style="list-style-type: none"> <li>Frame sizes FSA to FSG               <ul style="list-style-type: none"> <li>Transport in transport packaging acc. to EN 61800-5-1 and EN 60068-2-6</li> <li>Vibration during operation acc. to IEC 60721-3-3: 2002</li> </ul> </li> <li>Frame sizes FSH and FSJ               <ul style="list-style-type: none"> <li>Vibration in transport packaging: Test Fc acc. to EN 60068-2-64</li> <li>Shock in product packaging: Test Fc acc. to EN 60068-2-6</li> <li>Vibration during operation: Test Fc acc. to EN 60068-2-6</li> <li>Shock during operation: Test acc. to EN 60068-2-27</li> </ul> </li> </ul>	Class 2M3  Class 3M1  ±1.5 mm for 5 ... 9 Hz 0.5 × g at 9 ... 200 Hz ±1.5 mm for 5 ... 9 Hz 0.5 × g at 9 ... 200 Hz 0.075 mm at 10 ... 58 Hz 9.81 m/s <sup>2</sup> (1 × g) at > 58 ... 200 Hz Shock type EA 49 m/s <sup>2</sup> (5 × g)/30 ms 147 m/s <sup>2</sup> (15 × g)/11 ms
<b>Degree of protection</b>	
<ul style="list-style-type: none"> <li>Frame sizes FSA ... FSJ</li> <li>Frame sizes FSA ... FSG</li> </ul>	IP20/ UL Open Type Optional IP21/ UL Open Type with IP21 top covers
<b>Permissible mounting position</b>	Vertical wall mounting
<b>Ambient conditions</b>	
<b>External 24 V supply</b> according to IEC 60204-1	Touch-proof SELV or PELV power supply. The supply voltage must not exceed 60 V DC under single-fault conditions. <sup>1)</sup>
<b>Protection class</b> according to IEC 61800-5-1	Class I (with protective grounding conductor)
<b>Humidity, max.</b>	<95 % at 40 °C (104 °F), condensation and icing not permissible
<b>Ambient temperature</b>	
<ul style="list-style-type: none"> <li>Storage acc. to EN 60068-2-1               <ul style="list-style-type: none"> <li>Frame sizes FSA to FSG</li> <li>Frame sizes FSH and FSJ</li> </ul> </li> <li>Transport acc. to EN 60068-2-1</li> <li>Operation acc. to EN 60068-2-2               <ul style="list-style-type: none"> <li>Frame sizes FSA to FSG</li> </ul> </li> <li>Frame sizes FSH and FSJ</li> <li>All frame sizes with operator panel</li> </ul>	-40 ... +70 °C (-40 ... +158 °F) -25 ... +55 °C (-13 ... +131 °F) -40 ... +70 °C (-40 ... +158 °F)  Variant PROFINET, EthernNet/IP: -20 °C ... +55 °C (-4 ... +131 °F) with a side clearance of 5 cm or -20 °C ... +50 °C (-4 ... +122 °F) for side-by-side mounting, >45 °C (113 °F) with derating Variants PROFIBUS DP and USS, Modbus RTU, BACnet MS/TP: -20 °C ... +60 °C (-4 ... +140 °F) with a side clearance of 5 cm or -20 °C ... +50 °C (-4 ... +122 °F) for side-by-side mounting, >45 °C (113 °F) with derating 0 ... 55 °C (32 ... 131 °F) , >45 °C (113 °F) with derating 0 ... 50 °C (32 ... 122 °F) <a href="#">see also derating characteristics</a>
<b>Environmental class in operation</b>	
<ul style="list-style-type: none"> <li>Harmful chemical substances               <ul style="list-style-type: none"> <li>Frame sizes FSA to FSG</li> <li>Frame sizes FSH and FSJ</li> </ul> </li> <li>Organic/biological pollutants</li> <li>Degree of pollution</li> </ul>	Class 3C2 acc. to IEC 60721-3-3: 2002 Optional: Class 3C3 acc. to IEC 60721-3-3: 2002 <sup>2)</sup> Class 3C2 acc. to IEC 60721-3-3: 2002 Class 3B1 acc. to IEC 60721-3-3: 2002 2 acc. to EN 61800

<sup>1)</sup> Only supported for SINAMICS G120X converters with hardware version ≥ 02 02 (FSA to FSG) / 02 (FSH/FSJ). The hardware version of the converter is on the rating plate.

<sup>2)</sup> Only supported for SINAMICS G120X converters with hardware version ≥ 02 02. The hardware version of the converter is on the rating plate.

# SINAMICS G120X infrastructure converters for HVAC/Water/Wastewater

0.75 kW to 630 kW (1 hp to 700 hp)

## SINAMICS G120X infrastructure converters for HVAC/Water/Wastewater

### Technical specifications

#### General technical specifications (continued)

##### Standards

##### Compliance with standards <sup>1)</sup>

- Frame sizes FSA to FSG CE, UKCA, UL, cUL, RCM, SEMI F47, RoHS II, EAC, KCC, REACH
- Frame sizes FSH and FSJ CE, UKCA, UL, cUL, RCM, SEMI F47, RoHS II, EAC, REACH

##### Fail-safe certification

- According to IEC 61508 Function: Safe Torque Off (STO)
- According to ISO 13849-1 SIL 3

External components (e.g. **SIRIUS 3SK1** safety relays) are necessary for using the STO safety function according to IEC 61508 SIL 2/SIL 3. <sup>1)</sup>

SINAMICS G120X	SIL 2		SIL 3	
	Forced checking procedure (test stop) once per year		Forced checking procedure (test stop) once per 3 months	
	SIRIUS 3SK1 safety relay <u>with</u>		SIRIUS 3SK1 safety relay <u>with</u>	
	Screw terminal	Spring-loaded terminal (push-in)	Screw terminal	Spring-loaded terminal (push-in)
Frame size	Type	Type	Type	Type
FSA to FSG	3SK1111-1AB30	3SK1111-2AB30	3SK2112-1AA10	3SK2112-2AA10
FSH and FSJ	3SK1111-1AB30	3SK1111-2AB30	3SK1111-1AB30	3SK1111-2AB30

##### CE marking, according to

EMC Directive 2014/30/EU  
Low Voltage Directive 2014/35/EU  
Eco-design requirements of EU Directive 2019/1781

##### EMC Directive <sup>1)</sup>

acc. to EN 61800-3

- Interference immunity The SINAMICS G120X converters are tested according to the interference immunity requirements for environments according to Category C3.
- Interference emissions
  - Frame sizes FSA to FSF without integrated line filter <sup>2)</sup>
  - Frame sizes FSA to FSG with integrated line filter Category C2 Observance of the limit values according for conducted RF emissions according to IEC 61800-3 Category C2 / EN 55011:2016 Class A
  - Frame sizes FSG to FSJ with integrated line filter Category C3 Observance of the limit values according for conducted RF emissions according to IEC 61800-3 Category C3
  - Frame sizes FSH and FSJ with integrated line filter Category C3 with optional line filter Category C2 and optional line reactor Observance of the limit values according for conducted RF emissions according to IEC 61800-3 Category C2 / EN 55011:2016 Class A
  - Frame sizes FSA to FSF ≤ 90 kW without integrated line filter with optional line filter Category C1 Observance of the limit values according for conducted RF emissions according to IEC 61800-3 Category C1 / EN 55011:2016 Class B
  - Frame size FSF 110 kW with integrated line filter Category C2 with optional line filter Category C1 Observance of the limit values according for conducted RF emissions according to IEC 61800-3 Category C1 / EN 55011:2016 Class B

##### Note:

The EMC product standard EN 61800-3 does not apply directly to a frequency converter but to a PDS (Power Drive System), which comprises the complete circuitry, motor and cables in addition to the converter. The frequency converters on their own do not generally require identification according to the EMC Directive.

<sup>1)</sup> Additional information is available in the operating instructions on the internet at: [www.siemens.com/sinamics-g120x/documentation](http://www.siemens.com/sinamics-g120x/documentation)

<sup>2)</sup> Non-filtered devices are designed for operation in IT systems or in conjunction with an RCD. The customer must provide suitable RI suppression equipment to ensure that these devices comply with the limits defined for Category C3.

# SINAMICS G120X infrastructure converters for HVAC/Water/Wastewater

0.75 kW to 630 kW (1 hp to 700 hp)

## SINAMICS G120X infrastructure converters for HVAC/Water/Wastewater

### Technical specifications

SINAMICS G120X converters			
Integrated bus interface	Variant PROFINET, EtherNet/IP	Variant PROFIBUS DP	Variant USS, Modbus RTU, BACnet MS/TP
<b>Fieldbus protocols</b>	<ul style="list-style-type: none"> <li>PROFINET</li> <li>EtherNet/IP</li> </ul>	<ul style="list-style-type: none"> <li>PROFIBUS DP</li> </ul>	<ul style="list-style-type: none"> <li>USS</li> <li>Modbus RTU</li> <li>BACnet MS/TP</li> </ul>
<b>Hardware</b>	2 × RJ45, device name can be stored on the device, max. 100 Mbit/s (full duplex)	9-pin SUB-D socket, isolated, max. 12 Mbit/s	RS485 connected at a terminal, isolated, bus terminating resistor can be switched in, USS: max. 187.5 kBaud Modbus RTU: 19.2 kBaud BACnet MS/TP: max. 187.5 kBaud
I/O interfaces			
<b>Signal cable cross-section</b>	0.15 ... 1.5 mm <sup>2</sup> (28 ... 16 AWG)		
<b>Digital inputs – standard</b>	6 isolated inputs Optically isolated; Free reference potential (own potential group) NPN/PNP logic can be selected using the wiring		
<ul style="list-style-type: none"> <li>Switching level: 0 → 1</li> <li>Switching level: 1 → 0</li> </ul>	11 V 5 V		
<b>Digital inputs – fail-safe</b>	1 isolated input Max. input voltage 60 V Safety function: Safe Torque Off (STO) External components (e.g. safety relays) are necessary for using the STO safety function.		
<b>Digital outputs</b>	2 relay changeover contacts 250 V AC, 2 A (inductive load), 30 V DC, 2 A (ohmic load)		
<b>Analog inputs</b>	2 analog inputs Differential input Switchable between voltage (-10 ... +10 V) and current (0/4 ... 20 mA) using a DIP switch 12-bit resolution Can be used as additional digital input		
<ul style="list-style-type: none"> <li>Switching threshold: 0 → 1</li> <li>Switching threshold: 1 → 0</li> </ul>	4 V 1.6 V		
<b>Analog outputs</b>	1 non-isolated output Switchable between voltage (0 ... 10 V) and current (0/4 ... 20 mA) using a parameter Voltage mode: 10 V, min. burden 10 kΩ Current mode: 20 mA, max. burden 500 Ω The analog outputs have short-circuit protection		
<b>PTC/KTY/Pt100/Pt1000 interface</b>	1 motor temperature sensor input Connectable sensors PTC, Pt1000, KTY and bimetal <b>Note:</b> Connection and evaluation of a recommended, optional Pt100 temperature sensor possible by using a free analog input and output		
<b>Voltage supply for the integrated Control Unit</b>	24 V DC via the Power Module or by connecting to an external 20.4 ... 28.8 V DC power supply Typical input current: 500 mA at 24 V DC		
Tool interfaces			
<b>Memory card</b>	Optional SINAMICS SD card		
<b>Operator panels</b>	Optional BOP-2 Basic Operator Panel or IOP-2 Intelligent Operator Panel or SINAMICS G120 Smart Access		

## SINAMICS G120X infrastructure converters for HVAC/Water/Wastewater

0.75 kW to 630 kW (1 hp to 700 hp)

### SINAMICS G120X infrastructure converters for HVAC/Water/Wastewater

#### Technical specifications

SINAMICS G120X converters	
<b>Open-loop/closed-loop control techniques</b>	
V/f linear/quadratic/parameterizable	✓
V/f with flux current control (FCC)	✓
V/f ECO linear/quadratic	✓
Vector control, sensorless	✓
<b>Software functions</b>	
Setpoint input, can be parameterized	✓
Fixed frequencies	16, parameterizable
JOG	✓
Digital motorized potentiometer (MOP)	✓
Ramp smoothing	✓
Extended ramp-function generator (with ramp smoothing OFF3)	✓
Slip compensation	✓
Switchable drive data sets (DDS)	✓ (4)
Switchable command data sets (CDS)	✓ (2)
Free function blocks (FFB) for logical and arithmetic operations	✓ (for frame sizes FSA to FSG)
Flying restart	✓
Automatic restart after line supply failure or operating fault (AR)	✓
Technology controller (internal PID)	✓
Energy saving display	✓
3 additional, free PID controllers	✓
Hibernation mode with internal/external PID controller	✓
Belt monitoring with and without sensor (load torque monitoring)	✓
Dry-running/overload protection monitoring (load torque monitoring)	✓
Deragging	✓
Thermal motor protection	✓ ( $\hat{P}_t$ , sensor: PTC, Pt100, Pt1000, KTY and bimetal)
Thermal converter protection	✓
Motor identification	✓
Auto-ramping ( $V_{dc\_max}$ controller)	✓
Kinetic buffering ( $V_{dc\_min}$ controller)	✓
<b>Braking functions</b>	
• DC braking	✓
• Compound braking	✓

2



# SINAMICS G120X infrastructure converters for HVAC/Water/Wastewater

0.75 kW to 630 kW (1 hp to 700 hp)

## SINAMICS G120X infrastructure converters for HVAC/Water/Wastewater

### Technical specifications

#### General technical specifications of the power electronics

##### System operating voltage

- Frame sizes FSA to FSG
  - For systems complying with IEC:
    - 200 ... 240 V 3 AC +10 % -20 %
    - 380 ... 480 V 3 AC +10 % -20 %
    - 500 ... 690 V 3 AC +10 % -20 %
  - For systems complying with UL:
    - 200 ... 240 V 3 AC
    - 380 ... 480 V 3 AC
    - 500 ... 600 V 3 AC
- Frame sizes FSH and FSJ
  - 380 ... 480 V 3 AC +10 % -15 %
  - 500 ... 690 V 3 AC +10 % -15 %

##### Line supply requirements Line impedance $u_K$

- Frame sizes FSA to FSG
  - 4 %
- Frame sizes FSH and FSJ
  - A line reactor ( $u_K = 2 %$ ) must be connected in series, if the short-circuit power ratio  $R_{SC} > 33$  (315 ... 500 kW) or  $R_{SC} > 20$  (560 kW)

##### Input frequency

47 ... 63 Hz

##### Output frequency

- Frame sizes FSA to FSG
  - Control mode V/f: 0 ... 550 Hz
  - Control mode Vector: 0 ... 240 Hz
- Frame sizes FSH and FSJ
  - Control mode V/f: 0 ... 150 Hz
  - Control mode Vector: 0 ... 150 Hz

##### Pulse frequency

- Frame sizes FSA to FSG
  - 200 V:
    - 4 kHz
    - Higher pulse frequencies up to 16 kHz [see derating data](#)
  - 400 V:
    - 4 kHz for converters with a rated power  $\leq 90$  kW
    - 2 kHz for converters with a rated power  $\geq 110$  kW
    - Higher pulse frequencies up to 16 kHz [see derating data](#)
  - 690 V:
    - 2 kHz
    - Higher pulse frequencies up to 4 kHz [see derating data](#)
- Frame sizes FSH and FSJ
  - 2 kHz
  - Self-adjusting up to 4 kHz [see derating data](#)

##### Power factor $\lambda$

- Frame sizes FSA to FSC
  - 0.70 ... 0.85
- Frame sizes FSD to FSG
  - 0.90 ... 0.95
- Frame sizes FSH and FSJ
  - 0.75 ... 0.93 (with line reactor  $u_K = 2 %$ )

##### Displacement factor $\cos \varphi$

- Frame sizes FSA to FSC
  - 0.96
- Frame sizes FSD to FSG
  - 0.99
- Frame sizes FSH and FSJ
  - 0.96

##### Converter efficiency acc. to IEC 61800-9-2

200 V: 95,3 ... 96,7 %  
400 V: 96,2 ... 97,9 %  
690 V: 96,5 ... 98,2 %

##### Efficiency class

acc. to IEC 61800-9-2

IE2

##### Output voltage, max. as % of line voltage

97 %

##### Overload capability

- Low overload (LO)
  - 1.1 × base-load current  $I_L$  (i. e. 110 % overload) for 60 s within a cycle time of 300 s
- High overload (HO)
  - 1.5 × base-load current  $I_H$  (i. e. 150 % overload) for 60 s within a cycle time of 600 s

##### Cooling

Air cooling using an integrated fan

##### Installation altitude

Up to 1000 m (3281 ft) above sea level without derating,  
>1000 m (3281 ft) [see derating characteristics](#)

##### Short Circuit Current Rating (SCCR) max.

100 kA [see Recommended line-side overcurrent protection devices](#) – the value depends on the fuses and circuit breakers used  
For more information, see: <https://support.industry.siemens.com/cs/document/109762895>

##### Protection functions

- Undervoltage
- Overvoltage
- Overcurrent/overload
- Ground fault
- Short-circuit
- Stall protection
- Motor blocking protection
- Motor overtemperature
- Converter overtemperature
- Parameter locking

# SINAMICS G120X infrastructure converters for HVAC/Water/Wastewater

0.75 kW to 630 kW (1 hp to 700 hp)

## SINAMICS G120X infrastructure converters for HVAC/Water/Wastewater

### Technical specifications

#### Maximum permissible motor cable lengths SINAMICS G120X

The values specified in the table below apply with low-capacitance CY cables and with pulse frequencies set in the factory.

	Maximum permissible motor cable lengths (shielded/unshielded) in m (ft)			
	FSA to FSC	FSD and FSE	FSF and FSG	FSH and FSJ
<b>Without compliance to the EMC category</b>				
<b>Converters without optional power components</b>				
• 200 V versions	150/300 (492/984)	200/300 (656/984)	FSF: 300/450 (984/1476)	–
• 400 V versions	150/300 (492/984)	200/300 (656/984)	300/450 (984/1476)	150/200 (492/656)
• 690 V versions	–	FSD ≤ 30 kW: 200/300 (656/984) FSD 37 kW, FSE: 300/450 (984/1476)	300/450 (984/1476)	150/200 (492/656)
<b>Converters with one optional output reactor</b>				
• 200 V versions	–	–	–	–
• 400 V versions	–	200/300 (656/984) <sup>1)</sup>	300/450 (984/1476) <sup>1)</sup>	300/450 (984/1476)
• 690 V versions	–	350/525 (1148/1723)	525/800 (1723/2625)	300/450 (984/1476)
<b>Converters with two in series connected optional output reactors <sup>1)</sup></b>				
• 200 V versions	–	–	–	–
• 400 V versions	–	350/525 (1148/1723)	525/800 (1723/2625)	–
• 690 V versions	–	–	–	–
<b>Converters with optional sine-wave filter</b>				
• 200 V versions	–	–	–	–
• 400 V versions	200/300 (656/984)	200/300 (656/984)	FSF: 200/300 (656/984) FSG: 300/450 (984/1476)	–
• 690 V versions	–	–	–	–
<b>Converters with optional dv/dt filter plus VPL</b>				
• 200 V versions	–	–	–	–
• 400 V versions	–	350/525 (1148/1723)	650/800 (2133/2625)	300/450 (984/1476)
• 690 V versions	–	FSD ≤ 30 kW: 350/525 (1148/1723) FSD 37 kW, FSE: 450/625 (1476/2051) <sup>2)</sup>	450/625 (1476/2051) <sup>2)</sup>	300/450 (984/1476)
<b>With compliance to the EMC category <sup>3)</sup></b>				
<b>Converters with integrated line filter</b> for observance of the limit values for conducted RF emissions according to IEC 61800-3 <u>Category C3</u>				
• 200 V versions	–	–	–	–
• 400 V versions	150/– (492/–)	200/– (656/–)	200/– (656/–)	150/– (492/–) <sup>4)</sup>
• 690 V versions	–	150/– (492/–)	150/– (492/–)	150/– (492/–) <sup>4)</sup>
<b>Converters with integrated line filter with external line filter <u>Category C2</u></b> for observance of the limit values for conducted RF emissions according to IEC 61800-3 <u>Category C2</u> / EN 55011:2016 Class A				
• 200 V versions	–	–	–	–
• 400 V versions	–	–	–	150/– (492/–)
• 690 V versions	–	–	–	150/– (492/–)
<b>Converters with integrated line filter</b> for observance of the limit values for conducted RF emissions according to IEC 61800-3 <u>Category C2</u> / EN 55011:2016 Class A				
• 200 V versions	–	–	–	–
• 400 V versions	150/– (492/–)	150/– (492/–)	150/– (492/–)	–
• 690 V versions	–	100/– (328/–)	–	–
<b>Converters with integrated line filter with external sine-wave filter</b> for observance of the limit values for conducted RF emissions according to IEC 61800-3 <u>Category C2</u> / EN 55011:2016 Class A or according to IEC 61800-3 <u>Category C3</u>				
• 200 V versions	–	–	–	–
• 400 V versions	<u>Category C2</u> FSA: 100/– (328/–) FSB: 200/– (656/–) <u>Category C3</u> FSC: 200/– (656/–)	<u>Category C2</u> 150/– (492/–)	<u>Category C2</u> 150/– (492/–)	–
• 690 V versions	–	–	–	–
<b>Converters without/with integrated line filter with external line filter <u>Category C1</u></b> for observance of the limit values for conducted RF emissions according to IEC 61800-3 <u>Category C1</u> / EN 55011:2016 Class B				
• 200 V versions	–	–	–	–
• 400 V versions	Without integrated line filter 50/– (164/–) <sup>3)</sup>	Without integrated line filter 50/– (164/–) <sup>3)</sup>	Without integrated line filter FSF ≤ 90 kW: 50/– (164/–) <sup>3)</sup> With integrated line filter FSF 110 kW: 10/– (23.8/–) <sup>3)</sup>	–
• 690 V versions	–	–	–	–

<sup>1)</sup> For frame sizes FSD to FSG the maximum permissible cable lengths are not increased with one output reactor. By means of the output reactor, the loading of the motor windings is reduced by lower rates of voltage rise ( $dv/dt$ ). By means of two output reactors connected in series, the maximum permissible cable lengths for frame sizes FSD to FSG are increased.

<sup>2)</sup> Maximum overvoltage at the motor terminals < 1350 V.

<sup>3)</sup> Further information especially to achieve EMC Category C1 is available in the manual on the internet at:  
[www.siemens.com/sinamics-g120x/documentation](http://www.siemens.com/sinamics-g120x/documentation)

<sup>4)</sup> For motor cable lengths of 100 m (328 ft) up to 150 m (492 ft) with an additional basic interference suppression module (available on request).

# SINAMICS G120X infrastructure converters for HVAC/Water/Wastewater

0.75 kW to 630 kW (1 hp to 700 hp)

## SINAMICS G120X infrastructure converters for HVAC/Water/Wastewater

### Technical specifications

#### SINAMICS G120X converters · Degree of protection IP20/UL Open Type · 200 ... 240 V 3 AC

		6SL32.0-.YC10-.U.0	6SL32.0-.YC12-.U.0	6SL32.0-.YC14-.U.0	6SL32.0-.YC16-.U.0
Type of voltage		3 AC	3 AC	3 AC	3 AC
Line voltage	V	200 ... 240	200 ... 240	200 ... 240	200 ... 240
Output current at line voltage 200 V					
• without overload rated value	A	4.4	6.1	7.7	10.8
• with low overload rated value	A	4.2	6.0	7.4	10.4
• with high overload rated value	A	3.2	4.2	6.0	7.4
• maximum	A	5.7	8.1	10.0	14.1
Supplied active power at rated value of output voltage and at line voltage 200 V					
• with low overload	kW	0.75	1.1	1.5	2.2
• with high overload	kW	0.55	0.75	1.1	1.5
Supplied active power [hp] at rated value of output voltage and at line voltage 240 V					
• with low overload	hp	1	1.5	2	3
• with high overload	hp	0.75	1	1.5	2
Pulse frequency	kHz	4	4	4	4
Efficiency		0.956	0.955	0.953	0.962
Power loss <sup>1)</sup>	kW	0.058	0.084	0.109	0.123
Cooling air flow	m <sup>3</sup> /s (ft <sup>3</sup> /h)	0.005 (0.177)	0.0092 (0.325)	0.0092 (0.325)	0.0092 (0.325)
1 m measuring surface sound pressure level maximum	dB	55	55	55	63
Input current at line voltage 200 V					
• with low overload rated value	A	3.8	5.4	6.7	9.6
• with high overload rated value	A	2.8	3.8	5.4	6.7
for mains supply line					
• Type of electrical connection		Screw-type terminals	Screw-type terminals	Screw-type terminals	Screw-type terminals
• Number of connections		1	1	1	1
• Connectable conductor cross-section	mm <sup>2</sup>	1.5 ... 2.5	1.5 ... 2.5	1.5 ... 2.5	1.5 ... 6
• as coded connectable conductor cross section		AWG 16 ... AWG 14	AWG 16 ... AWG 14	AWG 16 ... AWG 14	AWG 16 ... AWG 10
for motor supply line					
• Type of electrical connection		Screw-type terminals	Screw-type terminals	Screw-type terminals	Screw-type terminals
• Number of connections		1	1	1	1
• Connectable conductor cross-section	mm <sup>2</sup>	1.5 ... 2.5	1.5 ... 2.5	1.5 ... 2.5	1.5 ... 6
• as coded connectable conductor cross section		AWG 16 ... AWG 14	AWG 16 ... AWG 14	AWG 16 ... AWG 14	AWG 16 ... AWG 10
Type of electrical connection for PE conductor		On housing with M4 screw	On housing with M4 screw	On housing with M4 screw	On housing with M4 screw
Cable length for motor					
• shielded maximum <sup>2)</sup>	m (ft)	150 (492.12598)	150 (492.12598)	150 (492.12598)	150 (492.12598)
• unshielded maximum <sup>2)</sup>	m (ft)	300 (984.25197)	300 (984.25197)	300 (984.25197)	300 (984.25197)
Dimensions					
• Width	mm (in)	73 (2.87402)	73 (2.87402)	73 (2.87402)	100 (3.93701)
• Height	mm (in)	232 (9.13386)	232 (9.13386)	232 (9.13386)	275 (10.82677)
• Depth	mm (in)	209 (8.22835)	209 (8.22835)	209 (8.22835)	209 (8.22835)
• Depth, with operator panel	mm (in)	218 (8.58268)	218 (8.58268)	218 (8.58268)	218 (8.58268)
Frame size		FSA	FSA	FSA	FSB
Weight, approx.	kg (lb)	3.3 (7.275246)	3.3 (7.275246)	3.3 (7.275246)	5.8 (12.786796)

<sup>1)</sup> Typical values acc. to IEC 61800-9-2.  
More information can be found on the internet at  
<https://support.industry.siemens.com/cs/document/94059311>

<sup>2)</sup> The values apply without compliance to the EMC category.  
For more information, see Maximum permissible motor cable lengths  
SINAMICS G120X and on the internet at  
[www.siemens.com/sinamics-g120x/documentation](http://www.siemens.com/sinamics-g120x/documentation)

# SINAMICS G120X infrastructure converters for HVAC/Water/Wastewater

0.75 kW to 630 kW (1 hp to 700 hp)

## SINAMICS G120X infrastructure converters for HVAC/Water/Wastewater

### Technical specifications

		6SL32.0-.YC18-.U.0	6SL32.0-.YC20-.U.0	6SL32.0-.YC22-.U.0	6SL32.0-.YC24-.U.0
Type of voltage		3 AC	3 AC	3 AC	3 AC
Line voltage	V	200 ... 240	200 ... 240	200 ... 240	200 ... 240
Output current at line voltage 200 V					
• without overload rated value	A	14.1	18.1	22.8	29.0
• with low overload rated value	A	13.6	17.5	22.0	28.0
• with high overload rated value	A	10.4	13.6	17.5	22.0
• maximum	A	18.4	23.7	29.7	37.8
Supplied active power at rated value of output voltage and at line voltage 200 V					
• with low overload	kW	3	4	5.5	7.5
• with high overload	kW	2.2	3	4	5.5
Supplied active power [hp] at rated value of output voltage and at line voltage 240 V					
• with low overload	hp	4	5	7.5	10
• with high overload	hp	3	4	5	7.5
Pulse frequency	kHz	4	4	4	4
Efficiency		0.961	0.959	0.964	0.961
Power loss <sup>1)</sup>	kW	0.165	0.223	0.269	0.365
Cooling air flow	m <sup>3</sup> /s (ft <sup>3</sup> /h)	0.0185 (0.653)	0.0185 (0.653)	0.0185 (0.653)	0.0185 (0.653)
1 m measuring surface sound pressure level maximum	dB	63	63	67	67
Input current at line voltage 200 V					
• with low overload rated value	A	12.7	16.3	20.8	26.3
• with high overload rated value	A	9.6	12.7	16.3	20.8
for mains supply line					
• Type of electrical connection		Screw-type terminals	Screw-type terminals	Screw-type terminals	Screw-type terminals
• Number of connections		1	1	1	1
• Connectable conductor cross-section	mm <sup>2</sup>	1.5 ... 6	1.5 ... 6	1.5 ... 16	1.5 ... 16
• as coded connectable conductor cross section		AWG 16 ... AWG 10	AWG 16 ... AWG 10	AWG 16 ... AWG 6	AWG 16 ... AWG 6
for motor supply line					
• Type of electrical connection		Screw-type terminals	Screw-type terminals	Screw-type terminals	Screw-type terminals
• Number of connections		1	1	1	1
• Connectable conductor cross-section	mm <sup>2</sup>	1.5 ... 6	1.5 ... 6	1.5 ... 16	1.5 ... 16
• as coded connectable conductor cross section		AWG 16 ... AWG 10	AWG 16 ... AWG 10	AWG 16 ... AWG 6	AWG 16 ... AWG 6
Type of electrical connection for PE conductor		On housing with M4 screw	On housing with M4 screw	On housing with M4 screw	On housing with M4 screw
Cable length for motor					
• shielded maximum <sup>2)</sup>	m (ft)	150 (492.12598)	150 (492.12598)	150 (492.12598)	150 (492.12598)
• unshielded maximum <sup>2)</sup>	m (ft)	300 (984.25197)	300 (984.25197)	300 (984.25197)	300 (984.25197)
Dimensions					
• Width	mm (in)	100 (3.93701)	100 (3.93701)	140 (5.51181)	140 (5.51181)
• Height	mm (in)	275 (10.82677)	275 (10.82677)	295 (11.61417)	295 (11.61417)
• Depth	mm (in)	209 (8.22835)	209 (8.22835)	209 (8.22835)	209 (8.22835)
• Depth, with operator panel	mm (in)	218 (8.58268)	218 (8.58268)	218 (8.58268)	218 (8.58268)
Frame size		FSB	FSB	FSC	FSC
Weight, approx.	kg (lb)	5.8 (12.786796)	5.8 (12.786796)	7.1 (15.652802)	7.1 (15.652802)

<sup>1)</sup> Typical values acc. to IEC 61800-9-2.  
More information can be found on the internet at  
<https://support.industry.siemens.com/cs/document/94059311>

<sup>2)</sup> The values apply without compliance to the EMC category.  
For more information, see Maximum permissible motor cable lengths  
SINAMICS G120X and on the internet at  
[www.siemens.com/sinamics-g120x/documentation](http://www.siemens.com/sinamics-g120x/documentation)

# SINAMICS G120X infrastructure converters for HVAC/Water/Wastewater

0.75 kW to 630 kW (1 hp to 700 hp)

## SINAMICS G120X infrastructure converters for HVAC/Water/Wastewater

### Technical specifications

		6SL32.0-.YC26-.U.0	6SL32.0-.YC28-.U.0	6SL32.0-.YC30-.U.0	6SL32.0-.YC32-.U.0
Type of voltage		3 AC	3 AC	3 AC	3 AC
Line voltage	V	200 ... 240	200 ... 240	200 ... 240	200 ... 240
Output current at line voltage 200 V					
• without overload rated value	A	43	56	70	82
• with low overload rated value	A	42	54	68	80
• with high overload rated value	A	28	42	54	68
• maximum	A	57	73	92	108
Supplied active power at rated value of output voltage and at line voltage 200 V					
• with low overload	kW	11	15	18.5	22
• with high overload	kW	7.5	11	15	18.5
Supplied active power [hp] at rated value of output voltage and at line voltage 240 V					
• with low overload	hp	15	20	25	30
• with high overload	hp	10	15	20	25
Pulse frequency	kHz	4	4	4	4
Efficiency		0.967	0.965	0.963	0.965
Power loss <sup>1)</sup>	kW	0.463	0.626	0.843	0.937
Cooling air flow	m <sup>3</sup> /s (ft <sup>3</sup> /h)	0.055 (1.942)	0.055 (1.942)	0.055 (1.942)	0.083 (2.931)
1 m measuring surface sound pressure level maximum	dB	70	70	70	70
Input current at line voltage 200 V					
• with low overload rated value	A	40	51	64	76
• with high overload rated value	A	26.3	40	51	64
for mains supply line					
• Type of electrical connection		Screw-type terminals	Screw-type terminals	Screw-type terminals	Screw-type terminals
• Number of connections		1	1	1	1
• Connectable conductor cross-section	mm <sup>2</sup>	10 ... 35	10 ... 35	10 ... 35	25 ... 70
• as coded connectable conductor cross section		AWG 8 ... AWG 2	AWG 8 ... AWG 2	AWG 8 ... AWG 2	AWG 6 ... AWG 3/0
for motor supply line					
• Type of electrical connection		Screw-type terminals	Screw-type terminals	Screw-type terminals	Screw-type terminals
• Number of connections		1	1	1	1
• Connectable conductor cross-section	mm <sup>2</sup>	10 ... 35	10 ... 35	10 ... 35	25 ... 70
• as coded connectable conductor cross section		AWG 8 ... AWG 2	AWG 8 ... AWG 2	AWG 8 ... AWG 2	AWG 6 ... AWG 3/0
Type of electrical connection for PE conductor		Screw-type terminals	Screw-type terminals	Screw-type terminals	Screw-type terminals
Cable length for motor					
• shielded maximum <sup>2)</sup>	m (ft)	200 (656.16798)	200 (656.16798)	200 (656.16798)	200 (656.16798)
• unshielded maximum <sup>2)</sup>	m (ft)	300 (984.25197)	300 (984.25197)	300 (984.25197)	300 (984.25197)
Dimensions					
• Width	mm (in)	200 (7.87402)	200 (7.87402)	200 (7.87402)	275 (10.82677)
• Height	mm (in)	472 (18.58268)	472 (18.58268)	472 (18.58268)	551 (21.69291)
• Depth	mm (in)	239 (9.40945)	239 (9.40945)	239 (9.40945)	239 (9.40945)
• Depth, with operator panel	mm (in)	248 (9.76378)	248 (9.76378)	248 (9.76378)	248 (9.76378)
Frame size		FSD	FSD	FSD	FSE
Weight, approx.	kg (lb)	16.6 (36.596692)	16.6 (36.596692)	16.6 (36.596692)	16.6 (36.596692)

<sup>1)</sup> Typical values acc. to IEC 61800-9-2.  
More information can be found on the internet at  
<https://support.industry.siemens.com/cs/document/94059311>

<sup>2)</sup> The values apply without compliance to the EMC category.  
For more information, see Maximum permissible motor cable lengths  
SINAMICS G120X and on the internet at  
[www.siemens.com/sinamics-g120x/documentation](http://www.siemens.com/sinamics-g120x/documentation)



## SINAMICS G120X infrastructure converters for HVAC/Water/Wastewater

0.75 kW to 630 kW (1 hp to 700 hp)

### SINAMICS G120X infrastructure converters for HVAC/Water/Wastewater

#### Technical specifications

		6SL32.0-.YC34-.U.0	6SL32.0-.YC36-.U.0	6SL32.0-.YC38-.U.0	6SL32.0-.YC40-.U.0
Type of voltage		3 AC	3 AC	3 AC	3 AC
Line voltage	V	200 ... 240	200 ... 240	200 ... 240	200 ... 240
Output current at line voltage 200 V					
• without overload rated value	A	107	133	158	197
• with low overload rated value	A	104	130	154	192
• with high overload rated value	A	80	104	130	154
• maximum	A	141	176	208	260
Supplied active power at rated value of output voltage and at line voltage 200 V					
• with low overload	kW	30	37	45	55
• with high overload	kW	22	30	37	45
Supplied active power [hp] at rated value of output voltage and at line voltage 240 V					
• with low overload	hp	40	50	60	75
• with high overload	hp	30	40	50	60
Pulse frequency	kHz	4	4	4	4
Efficiency		0.962	0.967	0.965	0.963
Power loss <sup>1)</sup>	kW	1.31	1.45	1.81	2.43
Cooling air flow	m <sup>3</sup> /s (ft <sup>3</sup> /h)	0.083 (2.931)	0.153 (5.403)	0.153 (5.403)	0.153 (5.403)
1 m measuring surface sound pressure level maximum	dB	70	72	72	72
Input current at line voltage 200 V					
• with low overload rated value	A	98	126	149	172
• with high overload rated value	A	76	98	126	149
for mains supply line					
• Type of electrical connection		Screw-type terminals	M10 screw	M10 screw	M10 screw
• Number of connections		1	2	2	2
• Connectable conductor cross-section	mm <sup>2</sup>	25 ... 70	35 ... 120	35 ... 120	35 ... 120
• as coded connectable conductor cross section		AWG 6 ... AWG 3/0	AWG 1 ... AWG 2 ×4/0	AWG 1 ... AWG 2 ×4/0	AWG 1 ... AWG 2 ×4/0
for motor supply line					
• Type of electrical connection		Screw-type terminals	M10 screw	M10 screw	M10 screw
• Number of connections		1	2	2	2
• Connectable conductor cross-section	mm <sup>2</sup>	25 ... 70	35 ... 120	35 ... 120	35 ... 120
• as coded connectable conductor cross section		AWG 6 ... AWG 3/0	AWG 1 ... AWG 2 ×4/0	AWG 1 ... AWG 2 ×4/0	AWG 1 ... AWG 2 ×4/0
Type of electrical connection for PE conductor		Screw-type terminals	M10 screw	M10 screw	M10 screw
Cable length for motor					
• shielded maximum <sup>2)</sup>	m (ft)	200 (656.16798)	300 (984.25197)	300 (984.25197)	300 (984.25197)
• unshielded maximum <sup>2)</sup>	m (ft)	300 (984.25197)	450 (1476.37795)	450 (1476.37795)	450 (1476.37795)
Dimensions					
• Width	mm (in)	275 (10.82677)	305 (12.00787)	305 (12.00787)	305 (12.00787)
• Height	mm (in)	551 (21.69291)	709 (27.91339)	709 (27.91339)	709 (27.91339)
• Depth	mm (in)	239 (9.40945)	360 (14.17323)	360 (14.17323)	360 (14.17323)
• Depth, with operator panel	mm (in)	248 (9.76378)	369 (14.52756)	369 (14.52756)	369 (14.52756)
Frame size		FSE	FSF	FSF	FSF
Weight, approx.	kg (lb)	16.6 (36.596692)	18.8 (41.446856)	17.6 (38.801312)	26.7 (58.863354)

<sup>1)</sup> Typical values acc. to IEC 61800-9-2.  
More information can be found on the internet at  
<https://support.industry.siemens.com/cs/document/94059311>

<sup>2)</sup> The values apply without compliance to the EMC category.  
For more information, see Maximum permissible motor cable lengths  
SINAMICS G120X and on the internet at  
[www.siemens.com/sinamics-g120x/documentation](http://www.siemens.com/sinamics-g120x/documentation)

# SINAMICS G120X infrastructure converters for HVAC/Water/Wastewater

0.75 kW to 630 kW (1 hp to 700 hp)

## SINAMICS G120X infrastructure converters for HVAC/Water/Wastewater

### Technical specifications

#### SINAMICS G120X converters · Degree of protection IP20/UL Open Type · 380 ... 480 V 3 AC

		6SL32.0-.YE10-.A.0 6SL32.0-.YE10-.U.0	6SL32.0-.YE12-.A.0 6SL32.0-.YE12-.U.0	6SL32.0-.YE14-.A.0 6SL32.0-.YE14-.U.0	6SL32.0-.YE16-.A.0 6SL32.0-.YE16-.U.0
Type of voltage		3 AC	3 AC	3 AC	3 AC
Line voltage	V	380 ... 480	380 ... 480	380 ... 480	380 ... 480
Output current at line voltage 400 V					
• without overload rated value	A	2.3	3.2	4.3	6.1
• with low overload rated value	A	2.2	3.1	4.1	5.9
• with high overload rated value	A	1.7	2.2	3.1	4.1
• maximum	A	2.7	3.4	4.8	6.4
Supplied active power at rated value of output voltage and at line voltage 400 V					
• with low overload	kW	0.75	1.1	1.5	2.2
• with high overload	kW	0.55	0.75	1.1	1.5
Supplied active power [hp] at rated value of output voltage and at line voltage 480 V					
• with low overload	hp	1	1.5	2	3
• with high overload	hp	0.75	1	1.5	2
Pulse frequency	kHz	4	4	4	4
Efficiency		0.962	0.966	0.966	0.970
Power loss <sup>1)</sup>	kW	0.043	0.055	0.071	0.090
Cooling air flow	m <sup>3</sup> /s (ft <sup>3</sup> /h)	0.005 (635.66406)	0.005 (635.66406)	0.005 (635.66406)	0.005 (635.66406)
1 m measuring surface sound pressure level maximum	dB	55	55	55	55
Input current at line voltage 400 V					
• with low overload rated value	A	2.1	2.8	3.6	5.5
• with high overload rated value	A	1.62	1.99	2.72	3.82
for mains supply line					
• Type of electrical connection		Screw-type terminals	Screw-type terminals	Screw-type terminals	Screw-type terminals
• Number of connections		1	1	1	1
• Connectable conductor cross-section	mm <sup>2</sup>	1.5 ... 2.5	1.5 ... 2.5	1.5 ... 2.5	1.5 ... 2.5
• as coded connectable conductor cross section		AWG 16 ... AWG 14	AWG 16 ... AWG 14	AWG 16 ... AWG 14	AWG 16 ... AWG 14
for motor supply line					
• Type of electrical connection		Screw-type terminals	Screw-type terminals	Screw-type terminals	Screw-type terminals
• Number of connections		1	1	1	1
• Connectable conductor cross-section	mm <sup>2</sup>	1.5 ... 2.5	1.5 ... 2.5	1.5 ... 2.5	1.5 ... 2.5
• as coded connectable conductor cross section		AWG 16 ... AWG 14	AWG 16 ... AWG 14	AWG 16 ... AWG 14	AWG 16 ... AWG 14
Type of electrical connection for PE conductor		On housing with M4 screw	On housing with M4 screw	On housing with M4 screw	On housing with M4 screw
Cable length for motor					
• shielded maximum <sup>2)</sup>	m (ft)	150 (492.12598)	150 (492.12598)	150 (492.12598)	150 (492.12598)
• unshielded maximum <sup>2)</sup>	m (ft)	300 (984.25197)	300 (984.25197)	300 (984.25197)	300 (984.25197)
Dimensions					
• Width	mm (in)	73 (2.87402)	73 (2.87402)	73 (2.87402)	73 (2.87402)
• Height	mm (in)	232 (9.13386)	232 (9.13386)	232 (9.13386)	232 (9.13386)
• Depth	mm (in)	209 (8.22835)	209 (8.22835)	209 (8.22835)	209 (8.22835)
• Depth, with operator panel	mm (in)	218 (8.58268)	218 (8.58268)	218 (8.58268)	218 (8.58268)
Frame size		FSA	FSA	FSA	FSA
Weight, approx. <sup>3)</sup>	kg (lb)	3.2 (7.05478)	3.2 (7.05478)	3.2 (7.05478)	3.2 (7.05478)

<sup>1)</sup> Typical values acc. to IEC 61800-9-2. More information can be found on the internet at <https://support.industry.siemens.com/cs/document/94059311>

<sup>2)</sup> The values apply without compliance to the EMC category. For more information, see Maximum permissible motor cable lengths SINAMICS G120X and on the internet at [www.siemens.com/sinamics-g120x/documentation](http://www.siemens.com/sinamics-g120x/documentation)

<sup>3)</sup> The values apply for converters without integrated line filter. For more information, see on the internet at [www.siemens.com/sinamics-g120x/documentation](http://www.siemens.com/sinamics-g120x/documentation)

# SINAMICS G120X infrastructure converters for HVAC/Water/Wastewater

0.75 kW to 630 kW (1 hp to 700 hp)

## SINAMICS G120X infrastructure converters for HVAC/Water/Wastewater

### Technical specifications

		6SL32.0-.YE18-.A.0 6SL32.0-.YE18-.U.0	6SL32.0-.YE20-.A.0 6SL32.0-.YE20-.U.0	6SL32.0-.YE22-.A.0 6SL32.0-.YE22-.U.0	6SL32.0-.YE24-.A.0 6SL32.0-.YE24-.U.0
Type of voltage		3 AC	3 AC	3 AC	3 AC
Line voltage	V	380 ... 480	380 ... 480	380 ... 480	380 ... 480
Output current at line voltage 400 V					
• without overload rated value	A	8	10.5	13.6	18.5
• with low overload rated value	A	7.7	10.2	13.2	18
• with high overload rated value	A	5.9	7.7	10.2	13.2
• maximum	A	9.1	14	18	24
Supplied active power at rated value of output voltage and at line voltage 400 V					
• with low overload	kW	3	4	5.5	7.5
• with high overload	kW	2.2	3	4	5.5
Supplied active power [hp] at rated value of output voltage and at line voltage 480 V					
• with low overload	hp	4	5	7.5	10
• with high overload	hp	3	4	5	7.5
Pulse frequency	kHz	4	4	4	4
Efficiency		0.969	0.973	0.974	0.974
Power loss <sup>1)</sup>	kW	0.123	0.140	0.187	0.253
Cooling air flow	m <sup>3</sup> /s (ft <sup>3</sup> /h)	0.005 (635.66406)	0.005 (635.66406)	0.0092 (1169.62187)	0.0092 (1169.62187)
1 m measuring surface sound pressure level maximum	dB	55	63	63	63
Input current at line voltage 400 V					
• with low overload rated value	A	6.9	9.75	12	17
• with high overload rated value	A	5.29	7.36	9.27	12.47
for mains supply line					
• Type of electrical connection		Screw-type terminals	Screw-type terminals	Screw-type terminals	Screw-type terminals
• Number of connections		1	1	1	1
• Connectable conductor cross-section	mm <sup>2</sup>	1.5 ... 2.5	1.5 ... 6	1.5 ... 6	1.5 ... 6
• as coded connectable conductor cross section		18 ... 14	10 ... 6	10 ... 6	10 ... 6
for motor supply line					
• Type of electrical connection		Screw-type terminals	Screw-type terminals	Screw-type terminals	Screw-type terminals
• Number of connections		1	1	1	1
• Connectable conductor cross-section	mm <sup>2</sup>	1.5 ... 2.5	1.5 ... 6	1.5 ... 6	1.5 ... 6
• as coded connectable conductor cross section		18 ... 14	10 ... 6	10 ... 6	10 ... 6
Type of electrical connection for PE conductor		On housing with M4 screw	On housing with M4 screw	On housing with M4 screw	On housing with M4 screw
Cable length for motor					
• shielded maximum <sup>2)</sup>	m (ft)	150 (492.12598)	150 (492.12598)	150 (492.12598)	150 (492.12598)
• unshielded maximum <sup>2)</sup>	m (ft)	300 (984.25197)	300 (984.25197)	300 (984.25197)	300 (984.25197)
Dimensions					
• Width	mm (in)	73 (2.87402)	100 (3.93701)	100 (3.93701)	100 (3.93701)
• Height	mm (in)	232 (9.13386)	275 (10.82677)	275 (10.82677)	275 (10.82677)
• Depth	mm (in)	209 (8.22835)	209 (8.22835)	209 (8.22835)	209 (8.22835)
• Depth, with operator panel	mm (in)	218 (8.58268)	218 (8.58268)	218 (8.58268)	218 (8.58268)
Frame size		FSA	FSB	FSB	FSB
Weight, approx. <sup>3)</sup>	kg (lb)	3.2 (7.05478)	5.83 (12.85293)	5.83 (12.85293)	5.83 (12.85293)

<sup>1)</sup> Typical values acc. to IEC 61800-9-2.  
More information can be found on the internet at  
<https://support.industry.siemens.com/cs/document/94059311>

<sup>2)</sup> The values apply without compliance to the EMC category.  
For more information, see Maximum permissible motor cable lengths  
SINAMICS G120X and on the internet at  
[www.siemens.com/sinamics-g120x/documentation](http://www.siemens.com/sinamics-g120x/documentation)

<sup>3)</sup> The values apply for converters without integrated line filter.  
For more information, see on the internet at  
[www.siemens.com/sinamics-g120x/documentation](http://www.siemens.com/sinamics-g120x/documentation)

# SINAMICS G120X infrastructure converters for HVAC/Water/Wastewater

0.75 kW to 630 kW (1 hp to 700 hp)

## SINAMICS G120X infrastructure converters for HVAC/Water/Wastewater

### Technical specifications

		6SL32.0-.YE26-.A.0 6SL32.0-.YE26-.U.0	6SL32.0-.YE28-.A.0 6SL32.0-.YE28-.U.0	6SL32.0-.YE30-.A.0 6SL32.0-.YE30-.U.0	6SL32.0-.YE32-.A.0 6SL32.0-.YE32-.U.0
Type of voltage		3 AC	3 AC	3 AC	3 AC
Line voltage	V	380 ... 480	380 ... 480	380 ... 480	380 ... 480
Output current at line voltage 400 V					
• without overload rated value	A	27	33	39	47
• with low overload rated value	A	26	32	38	45
• with high overload rated value	A	18	26	32	38
• maximum	A	35	43	51.3	61
Supplied active power at rated value of output voltage and at line voltage 400 V					
• with low overload	kW	11	15	18.5	22
• with high overload	kW	7.5	11	15	18.5
Supplied active power [hp] at rated value of output voltage and at line voltage 480 V					
• with low overload	hp	15	20	25	30
• with high overload	hp	10	15	20	25
Pulse frequency	kHz	4	4	4	4
Efficiency		0.976	0.976	0.972	0.971
Power loss <sup>1)</sup>	kW	0.340	0.432	0.591	0.723
Cooling air flow	m <sup>3</sup> /s (ft <sup>3</sup> /h)	0.0185 (2351,95680)	0.0185 (2351,95680)	0.055 (6992.30465)	0.055 (6992.30465)
1 m measuring surface sound pressure level maximum	dB	67	67	70	70
Input current at line voltage 400 V					
• with low overload rated value	A	24.5	29.5	36	42
• with high overload rated value	A	16.96	23.97	33	38
for mains supply line					
• Type of electrical connection		Screw-type terminals	Screw-type terminals	Screw-type terminals	Screw-type terminals
• Number of connections		1	1	1	1
• Connectable conductor cross-section	mm <sup>2</sup>	1.5 ... 16	1.5 ... 16	10 ... 35	10 ... 35
• as coded connectable conductor cross section		AWG 16 ... AWG 6	AWG 16 ... AWG 6	AWG 8 ... AWG 2	AWG 8 ... AWG 2
for motor supply line					
• Type of electrical connection		Screw-type terminals	Screw-type terminals	Screw-type terminals	Screw-type terminals
• Number of connections		1	1	1	1
• Connectable conductor cross-section	mm <sup>2</sup>	1.5 ... 16	1.5 ... 16	10 ... 35	10 ... 35
• as coded connectable conductor cross section		AWG 16 ... AWG 6	AWG 16 ... AWG 6	AWG 8 ... AWG 2	AWG 8 ... AWG 2
Type of electrical connection for PE conductor		On housing with M4 screw	On housing with M4 screw	Screw-type terminals	Screw-type terminals
Cable length for motor					
• shielded maximum <sup>2)</sup>	m (ft)	150 (492.12598)	150 (492.12598)	200 (656.16798)	200 (656.16798)
• unshielded maximum <sup>2)</sup>	m (ft)	300 (984.25197)	300 (984.25197)	300 (984.25197)	300 (984.25197)
Dimensions					
• Width	mm (in)	140 (5.51181)	140 (5.51181)	200 (7.87402)	200 (7.87402)
• Height	mm (in)	295 (11.61417)	295 (11.61417)	472 (18.58268)	472 (18.58268)
• Depth	mm (in)	209 (8.22835)	209 (8.22835)	239 (9.40945)	239 (9.40945)
• Depth, with operator panel	mm (in)	218 (8.58268)	218 (8.58268)	248 (9.76378)	248 (9.76378)
Frame size		FSC	FSC	FSD	FSD
Weight, approx. <sup>3)</sup>	kg (lb)	7.14 (15.74099)	7.14 (15.74099)	17 (37.47854)	17 (37.47854)

<sup>1)</sup> Typical values acc. to IEC 61800-9-2.  
More information can be found on the internet at  
<https://support.industry.siemens.com/cs/document/94059311>

<sup>2)</sup> The values apply without compliance to the EMC category.  
For more information, see Maximum permissible motor cable lengths  
SINAMICS G120X and on the internet at  
[www.siemens.com/sinamics-g120x/documentation](http://www.siemens.com/sinamics-g120x/documentation)

<sup>3)</sup> The values apply for converters without integrated line filter.  
For more information, see on the internet at  
[www.siemens.com/sinamics-g120x/documentation](http://www.siemens.com/sinamics-g120x/documentation)

# SINAMICS G120X infrastructure converters for HVAC/Water/Wastewater

0.75 kW to 630 kW (1 hp to 700 hp)

## SINAMICS G120X infrastructure converters for HVAC/Water/Wastewater

### Technical specifications

		6SL32.0-.YE34-.A.0 6SL32.0-.YE34-.U.0	6SL32.0-.YE36-.A.0 6SL32.0-.YE36-.U.0	6SL32.0-.YE38-.A.0 6SL32.0-.YE38-.U.0	6SL32.0-.YE40-.A.0 6SL32.0-.YE40-.U.0
Type of voltage		3 AC	3 AC	3 AC	3 AC
Line voltage	V	380 ... 480	380 ... 480	380 ... 480	380 ... 480
Output current at line voltage 400 V					
• without overload rated value	A	62	77	93	113
• with low overload rated value	A	60	75	90	110
• with high overload rated value	A	45	60	75	90
• maximum	A	81	102	122	149
Supplied active power at rated value of output voltage and at line voltage 400 V					
• with low overload	kW	30	37	45	55
• with high overload	kW	22	30	37	45
Supplied active power [hp] at rated value of output voltage and at line voltage 480 V					
• with low overload	hp	40	50	60	75
• with high overload	hp	30	40	50	60
Pulse frequency	kHz	4	4	4	4
Efficiency		0.975	0.974	0.974	0.972
Power loss <sup>1)</sup>	kW	0.834	1.10	1.33	1.71
Cooling air flow	m <sup>3</sup> /s (ft <sup>3</sup> /h)	0.055 (6992.30465)	0.055 (6992.30465)	0.083 (10552.02338)	0.083 (10552.02338)
1 m measuring surface sound pressure level maximum	dB	70	70	70	70
Input current at line voltage 400 V					
• with low overload rated value	A	57	70	86	104
• with high overload rated value	A	47	62	78	94
for mains supply line					
• Type of electrical connection		Screw-type terminals	Screw-type terminals	Screw-type terminals	Screw-type terminals
• Number of connections		1	1	1	1
• Connectable conductor cross-section	mm <sup>2</sup>	10 ... 35	10 ... 35	25 ... 70	25 ... 70
• as coded connectable conductor cross section		AWG 8 ... AWG 2	AWG 8 ... AWG 2	AWG 6 ... AWG 3/0	AWG 6 ... AWG 3/0
for motor supply line					
• Type of electrical connection		Screw-type terminals	Screw-type terminals	Screw-type terminals	Screw-type terminals
• Number of connections		1	1	1	1
• Connectable conductor cross-section	mm <sup>2</sup>	10 ... 35	10 ... 35	25 ... 70	25 ... 70
• as coded connectable conductor cross section		AWG 8 ... AWG 2	AWG 8 ... AWG 2	AWG 6 ... AWG 3/0	AWG 6 ... AWG 3/0
Type of electrical connection for PE conductor		Screw-type terminals	Screw-type terminals	Screw-type terminals	Screw-type terminals
Cable length for motor					
• shielded maximum <sup>2)</sup>	m (ft)	200 (656.16798)	200 (656.16798)	200 (656.16798)	200 (656.16798)
• unshielded maximum <sup>2)</sup>	m (ft)	300 (984.25197)	300 (984.25197)	300 (984.25197)	300 (984.25197)
Dimensions					
• Width	mm (in)	200 (7.87402)	200 (7.87402)	275 (10.82677)	275 (10.82677)
• Height	mm (in)	472 (18.58268)	472 (18.58268)	551 (21.69291)	551 (21.69291)
• Depth	mm (in)	239 (9.40945)	239 (9.40945)	239 (9.40945)	239 (9.40945)
• Depth, with operator panel	mm (in)	248 (9.76378)	248 (9.76378)	248 (9.76378)	248 (9.76378)
Frame size		FSD	FSD	FSE	FSE
Weight, approx. <sup>3)</sup>	kg (lb)	17 (37.47854)	19 (41.88778)	27 (59.52474)	27 (59.52474)

<sup>1)</sup> Typical values acc. to IEC 61800-9-2.  
More information can be found on the internet at  
<https://support.industry.siemens.com/cs/document/94059311>

<sup>2)</sup> The values apply without compliance to the EMC category.  
For more information, see Maximum permissible motor cable lengths  
SINAMICS G120X and on the internet at  
[www.siemens.com/sinamics-g120x/documentation](http://www.siemens.com/sinamics-g120x/documentation)

<sup>3)</sup> The values apply for converters without integrated line filter.  
For more information, see on the internet at  
[www.siemens.com/sinamics-g120x/documentation](http://www.siemens.com/sinamics-g120x/documentation)



# SINAMICS G120X infrastructure converters for HVAC/Water/Wastewater

0.75 kW to 630 kW (1 hp to 700 hp)

## SINAMICS G120X infrastructure converters for HVAC/Water/Wastewater

### Technical specifications

		6SL32.0-.YE42-.A.0 6SL32.0-.YE42-.U.0	6SL32.0-.YE44-.A.0 6SL32.0-.YE44-.U.0	6SL32.0-.YE46-.A.0 6SL32.0-.YE46-.U.0	6SL32.0-.YE48-.A.0 6SL32.0-.YE48-.U.0
Type of voltage		3 AC	3 AC	3 AC	3 AC
Line voltage	V	380 ... 480	380 ... 480	380 ... 480	380 ... 480
Output current at line voltage 400 V					
• without overload rated value	A	149	183	210	256
• with low overload rated value	A	145	178	205	250
• with high overload rated value	A	110	145	178	205
• maximum	A	196	241	277	338
Supplied active power at rated value of output voltage and at line voltage 400 V					
• with low overload	kW	75	90	110	132
• with high overload	kW	55	75	90	110
Supplied active power [hp] at rated value of output voltage and at line voltage 480 V					
• with low overload	hp	100	125	150	200
• with high overload	hp	75	100	125	150
Pulse frequency	kHz	4	4	2	2
Efficiency		0.976	0.974	0.979	0.978
Power loss <sup>1)</sup>	kW	1.97	2.57	2.37	3.10
Cooling air flow	m <sup>3</sup> /s (ft <sup>3</sup> /h)	0.153 (19451.32021)	0.153 (19451.32021)	0.153 (19451.32021)	0.153 (19451.32021)
1 m measuring surface sound pressure level maximum	dB	72	72	72	72
Input current at line voltage 400 V					
• with low overload rated value	A	140	172	198	242
• with high overload rated value	A	117	154	189	218
for mains supply line					
• Type of electrical connection		M10 screw	M10 screw	M10 screw	M10 screw
• Number of connections		2	2	2	2
• Connectable conductor cross-section	mm <sup>2</sup>	35 ... 120	35 ... 120	35 ... 120	35 ... 120
• as coded connectable conductor cross section		AWG 2 ... AWG 2 × 4/0	AWG 2 ... AWG 2 × 4/0	AWG 2 ... AWG 2 × 4/0	AWG 2 ... AWG 2 × 4/0
for motor supply line					
• Type of electrical connection		M10 screw	M10 screw	M10 screw	M10 screw
• Number of connections		2	2	2	2
• Connectable conductor cross-section	mm <sup>2</sup>	35 ... 120	35 ... 120	35 ... 120	35 ... 120
• as coded connectable conductor cross section		AWG 2 ... AWG 2 × 4/0	AWG 2 ... AWG 2 × 4/0	AWG 2 ... AWG 2 × 4/0	AWG 2 ... AWG 2 × 4/0
Type of electrical connection for PE conductor		M10 screw	M10 screw	M10 screw	M10 screw
Cable length for motor					
• shielded maximum <sup>2)</sup>	m (ft)	300 (984.25197)	300 (984.25197)	300 (984.25197)	300 (984.25197)
• unshielded maximum <sup>2)</sup>	m (ft)	450 (1476.37795)	450 (1476.37795)	450 (1476.37795)	450 (1476.37795)
Dimensions					
• Width	mm (in)	305 (12.00787)	305 (12.00787)	305 (12.00787)	305 (12.00787)
• Height	mm (in)	709 (27.91339)	709 (27.91339)	709 (27.91339)	709 (27.91339)
• Depth	mm (in)	360 (14.17323)	360 (14.17323)	360 (14.17323)	360 (14.17323)
• Depth, with operator panel	mm (in)	369 (14.52756)	369 (14.52756)	369 (14.52756)	369 (14.52756)
Frame size		FSF	FSF	FSF	FSF
Weight, approx. <sup>3)</sup>	kg (lb)	61 (134.48182)	61 (134.48182)	67 (147.70954)	67 (147.70954)

<sup>1)</sup> Typical values acc. to IEC 61800-9-2.  
More information can be found on the internet at  
<https://support.industry.siemens.com/cs/document/94059311>

<sup>2)</sup> The values apply without compliance to the EMC category.  
For more information, see Maximum permissible motor cable lengths  
SINAMICS G120X and on the internet at  
[www.siemens.com/sinamics-g120x/documentation](http://www.siemens.com/sinamics-g120x/documentation)

<sup>3)</sup> The values apply for converters without integrated line filter.  
For more information, see on the internet at  
[www.siemens.com/sinamics-g120x/documentation](http://www.siemens.com/sinamics-g120x/documentation)

# SINAMICS G120X infrastructure converters for HVAC/Water/Wastewater

0.75 kW to 630 kW (1 hp to 700 hp)

## SINAMICS G120X infrastructure converters for HVAC/Water/Wastewater

### Technical specifications

		6SL32.0-.YE50-.A.0 6SL32.0-.YE50-.C.0	6SL32.0-.YE52-.A.0 6SL32.0-.YE52-.C.0	6SL32.0-.YE54-.A.0 6SL32.0-.YE54-.C.0	6SL3220-.YE56-.C.0
Type of voltage		3 AC	3 AC	3 AC	3 AC
Line voltage	V	380 ... 480	380 ... 480	380 ... 480	380 ... 480
Output current at line voltage 400 V					
• without overload rated value	A	309	379	488	585
• with low overload rated value	A	302	370	477	570
• with high overload rated value	A	250	302	370	468
• maximum	A	408	500	644	770
Supplied active power at rated value of output voltage and at line voltage 400 V					
• with low overload	kW	160	200	250	315
• with high overload	kW	132	160	200	250
Supplied active power [hp] at rated value of output voltage and at line voltage 480 V					
• with low overload	hp	250	300	400	400
• with high overload	hp	200	250	300	300
Pulse frequency	kHz	2	2	2	4
Efficiency		0.979	0.978	0.977	0.979
Power loss <sup>1)</sup>	kW	3.66	4.61	6.17	6.83
Cooling air flow	m <sup>3</sup> /s (ft <sup>3</sup> /h)	0.21 (26697.89049)	0.21 (26697.89049)	0.21 (26697.89049)	0.362 (46022.07788)
1 m measuring surface sound pressure level maximum	dB	74	74	74	74
Input current at line voltage 400 V					
• with low overload rated value	A	301	365	471	585
• with high overload rated value	A	275	330	400	477
for mains supply line					
• Type of electrical connection		M10 screw	M10 screw	M10 screw	M12 screw
• Number of connections		2	2	2	4
• Connectable conductor cross-section	mm <sup>2</sup>	35 ... 185	35 ... 185	35 ... 185	240 ... 240
• as coded connectable conductor cross section		AWG 1 ... MCM 2 × 350	AWG 1 ... MCM 2 × 350	AWG 1 ... MCM 2 × 350	MCM 2 × 500 ... MCM 4 × 500
for motor supply line					
• Type of electrical connection		M10 screw	M10 screw	M10 screw	M12 screw
• Number of connections		2	2	2	4
• Connectable conductor cross-section	mm <sup>2</sup>	35 ... 185	35 ... 185	35 ... 185	240 ... 240
• as coded connectable conductor cross section		AWG 1 ... MCM 2 × 350	AWG 1 ... MCM 2 × 350	AWG 1 ... MCM 2 × 350	MCM 2 × 500 ... MCM 4 × 500
Type of electrical connection for PE conductor		M10 screw	M10 screw	M10 screw	M12 screw
Cable length for motor					
• shielded maximum <sup>2)</sup>	m (ft)	200 (656.16798)	200 (656.16798)	200 (656.16798)	150 (492.12598)
Dimensions					
• Width	mm (in)	305 (12.00787)	305 (12.00787)	305 (12.00787)	548 (21.5748)
• Height	mm (in)	999 (39.33071)	999 (39.33071)	999 (39.33071)	1695 (66.73228)
• Depth	mm (in)	360 (14.17323)	360 (14.17323)	360 (14.17323)	393 (15.47244)
• Depth, with operator panel	mm (in)	369 (14.52756)	369 (14.52756)	369 (14.52756)	393 (15.47244)
Frame size		FSG	FSG	FSG	FSH
Weight, approx.	kg (lb)	105 (231.48536)	113 (249.12234)	120 (264.5547)	151 (332.89799)

<sup>1)</sup> Typical values acc. to IEC 61800-9-2.  
More information can be found on the internet at  
<https://support.industry.siemens.com/cs/document/94059311>

<sup>2)</sup> The values apply with compliance to the EMC category C3.  
For more information, see Maximum permissible motor cable lengths  
SINAMICS G120X and on the internet at  
[www.siemens.com/sinamics-g120x/documentation](http://www.siemens.com/sinamics-g120x/documentation)

# SINAMICS G120X infrastructure converters for HVAC/Water/Wastewater

0.75 kW to 630 kW (1 hp to 700 hp)

## SINAMICS G120X infrastructure converters for HVAC/Water/Wastewater

### Technical specifications

		6SL3220-.YE58-.C.0	6SL3220-.YE60-.C.0	6SL3220-.YE62-.C.0	6SL3220-.YE64-.C.0	6SL3220-.YE66-.C.0
Type of voltage		3 AC	3 AC	3 AC	3 AC	3 AC
Line voltage	V	380 ... 480	380 ... 480	380 ... 480	380 ... 480	380 ... 480
Output current at line voltage 400 V						
• without overload rated value	A	655	735	840	910	1021
• with low overload rated value	A	640	720	820	890	1000
• with high overload rated value	A	491	551	672	728	786
• maximum	A	864	972	1107	1202	1350
Supplied active power at rated value of output voltage and at line voltage 400 V						
• with low overload	kW	355	400	450	500	560
• with high overload	kW	250	315	355	400	450
Supplied active power [hp] at rated value of output voltage and at line voltage 480 V						
• with low overload	hp	450	500	500	600	700
• with high overload	hp	300	350	450	500	500
Pulse frequency	kHz	4	4	4	4	4
Efficiency		0.978	0.979	0.978	0.979	0.979
Power loss <sup>1)</sup>	kW	8.02	8.83	10.2	10.5	12.2
Cooling air flow	m <sup>3</sup> /s (ft <sup>3</sup> /h)	0.362 (46022.07788)	0.362 (46022.07788)	0.45 (57209.76533)	0.45 (57209.76533)	0.45 (57209.76533)
1 m measuring surface sound pressure level maximum	dB	74	74	74	74	74
Input current at line voltage 400 V						
• with low overload rated value	A	654	735	850	924	1038
• with high overload rated value	A	501	562	696	756	816
for mains supply line						
• Type of electrical connection		M12 screw	M12 screw	M12 screw	M12 screw	M12 screw
• Number of connections		4	4	6	6	6
• Connectable conductor cross-section	mm <sup>2</sup>	240 ... 240	240 ... 240	240 ... 240	240 ... 240	240 ... 240
• as coded connectable conductor cross section		MCM 2 × 500 ... MCM 4 × 500	MCM 2 × 500 ... MCM 4 × 500	MCM 4 × 500 ... MCM 6 × 500	MCM 4 × 500 ... MCM 6 × 500	MCM 4 × 500 ... MCM 6 × 500
for motor supply line						
• Type of electrical connection		M12 screw	M12 screw	M12 screw	M12 screw	M12 screw
• Number of connections		4	4	6	6	6
• Connectable conductor cross-section	mm <sup>2</sup>	240 ... 240	240 ... 240	240 ... 240	240 ... 240	240 ... 240
• as coded connectable conductor cross section		MCM 2 × 500 ... MCM 4 × 500	MCM 2 × 500 ... MCM 4 × 500	MCM 4 × 500 ... MCM 8 × 500	MCM 4 × 500 ... MCM 8 × 500	MCM 4 × 500 ... MCM 8 × 500
Type of electrical connection for PE conductor		M12 screw	M12 screw	M12 screw	M12 screw	M12 screw
Cable length for motor						
• shielded maximum <sup>2)</sup>	m (ft)	150 (492.12598)	150 (492.12598)	150 (492.12598)	150 (492.12598)	150 (492.12598)
Dimensions						
• Width	mm (in)	548 (21.5748)	548 (21.5748)	801 (31.53543)	801 (31.53543)	801 (31.53543)
• Height	mm (in)	1695 (66.73228)	1695 (66.73228)	1621 (63.8189)	1621 (63.8189)	1621 (63.8189)
• Depth	mm (in)	393 (15.47244)	393 (15.47244)	393 (15.47244)	393 (15.47244)	393 (15.47244)
• Depth, with operator panel	mm (in)	393 (15.47244)	393 (15.47244)	393 (15.47244)	393 (15.47244)	393 (15.47244)
Frame size		FSH	FSH	FSJ	FSJ	FSJ
Weight, approx.	kg (lb)	157 (346.12573)	159 (350.53497)	236 (520.2909)	250 (551.15562)	250 (551.15562)

<sup>1)</sup> Typical values acc. to IEC 61800-9-2.  
More information can be found on the internet at  
<https://support.industry.siemens.com/cs/document/94059311>

<sup>2)</sup> The values apply with compliance to the EMC category.  
For more information, see Maximum permissible motor cable lengths  
SINAMICS G120X and on the internet at  
[www.siemens.com/sinamics-g120x/documentation](http://www.siemens.com/sinamics-g120x/documentation)

# SINAMICS G120X infrastructure converters for HVAC/Water/Wastewater

0.75 kW to 630 kW (1 hp to 700 hp)

## SINAMICS G120X infrastructure converters for HVAC/Water/Wastewater

### Technical specifications

#### SINAMICS G120X converters · Degree of protection IP20/UL Open Type · 500 ... 690 V 3 AC

		6SL32.0-.YH18-.A.0 6SL32.0-.YH18-.U.0	6SL32.0-.YH20-.A.0 6SL32.0-.YH20-.U.0	6SL32.0-.YH22-.A.0 6SL32.0-.YH22-.U.0	6SL32.0-.YH24-.A.0 6SL32.0-.YH24-.U.0
Type of voltage		3 AC	3 AC	3 AC	3 AC
Line voltage	V	500 ... 690	500 ... 690	500 ... 690	500 ... 690
Output current at line voltage 690 V					
• without overload rated value	A	6	7	10	12
• with low overload rated value	A	5	6.3	9	11
• with high overload rated value	A	4	5	6.3	9
• maximum	A	7	9	13	15
Supplied active power at rated value of output voltage and at line voltage 690 V					
• with low overload	kW	3	4	5.5	7.5
• with high overload	kW	2.2	3	4	5.5
Supplied active power [hp] at rated value of output voltage and at line voltage 600 V					
• with low overload	hp	4	5	7.5	10
• with high overload	hp	3	4	5	7.5
Pulse frequency	kHz	2	2	2	2
Efficiency		0.965	0.966	0.970	0.971
Power loss <sup>1)</sup>	kW	0.158	0.191	0.262	0.306
Cooling air flow	m <sup>3</sup> /s (ft <sup>3</sup> /h)	0.055 (6992.30465)	0.055 (6992.30465)	0.055 (6992.30465)	0.055 (6992.30465)
1 m measuring surface sound pressure level maximum	dB	70	70	70	70
Input current at line voltage 690 V					
• with low overload rated value	A	5	6	9	11
• with high overload rated value	A	4.4	5.2	6.9	9.9
for mains supply line					
• Type of electrical connection		Screw-type terminals	Screw-type terminals	Screw-type terminals	Screw-type terminals
• Number of connections		1	1	1	1
• Connectable conductor cross-section	mm <sup>2</sup>	10 ... 35	10 ... 35	10 ... 35	10 ... 35
• as coded connectable conductor cross section		AWG 8 ... AWG 2	AWG 8 ... AWG 2	AWG 8 ... AWG 2	AWG 8 ... AWG 2
for motor supply line					
• Type of electrical connection		Screw-type terminals	Screw-type terminals	Screw-type terminals	Screw-type terminals
• Number of connections		1	1	1	1
• Connectable conductor cross-section	mm <sup>2</sup>	10 ... 35	10 ... 35	10 ... 35	10 ... 35
• as coded connectable conductor cross section		AWG 8 ... AWG 2	AWG 8 ... AWG 2	AWG 8 ... AWG 2	AWG 8 ... AWG 2
Type of electrical connection for PE conductor		Screw-type terminals	Screw-type terminals	Screw-type terminals	Screw-type terminals
Cable length for motor					
• shielded maximum <sup>2)</sup>	m (ft)	200 (656.16798)	200 (656.16798)	200 (656.16798)	200 (656.16798)
• unshielded maximum <sup>2)</sup>	m (ft)	300 (984.25197)	300 (984.25197)	300 (984.25197)	300 (984.25197)
Dimensions					
• Width	mm (in)	200 (7.87402)	200 (7.87402)	200 (7.87402)	200 (7.87402)
• Height	mm (in)	472 (18.58268)	472 (18.58268)	472 (18.58268)	472 (18.58268)
• Depth	mm (in)	239 (9.40945)	239 (9.40945)	239 (9.40945)	239 (9.40945)
• Depth, with operator panel	mm (in)	248 (9.76378)	248 (9.76378)	248 (9.76378)	248 (9.76378)
Frame size		FSD	FSD	FSD	FSD
Weight, approx. <sup>3)</sup>	kg (lb)	16.6 (36.59669)	16.6 (36.59669)	16.6 (36.59669)	16.6 (36.59669)

<sup>1)</sup> Typical values acc. to IEC 61800-9-2. More information can be found on the internet at <https://support.industry.siemens.com/cs/document/94059311>

<sup>2)</sup> The values apply without compliance to the EMC category. For more information, see Maximum permissible motor cable lengths SINAMICS G120X and on the internet at [www.siemens.com/sinamics-g120x/documentation](http://www.siemens.com/sinamics-g120x/documentation)

<sup>3)</sup> The values apply for converters without integrated line filter. For more information, see on the internet at [www.siemens.com/sinamics-g120x/documentation](http://www.siemens.com/sinamics-g120x/documentation)

# SINAMICS G120X infrastructure converters for HVAC/Water/Wastewater

0.75 kW to 630 kW (1 hp to 700 hp)

## SINAMICS G120X infrastructure converters for HVAC/Water/Wastewater

### Technical specifications

		6SL32.0-.YH26-.A.0 6SL32.0-.YH26-.U.0	6SL32.0-.YH28-.A.0 6SL32.0-.YH28-.U.0	6SL32.0-.YH30-.A.0 6SL32.0-.YH30-.U.0	6SL32.0-.YH32-.A.0 6SL32.0-.YH32-.U.0
Type of voltage		3 AC	3 AC	3 AC	3 AC
Line voltage	V	500 ... 690	500 ... 690	500 ... 690	500 ... 690
Output current at line voltage 690 V					
• without overload rated value	A	15	20	24	28
• with low overload rated value	A	14	19	23	27
• with high overload rated value	A	11	14	19	23
• maximum	A	19	26	32	37
Supplied active power at rated value of output voltage and at line voltage 690 V					
• with low overload	kW	11	15	18.5	22
• with high overload	kW	7.5	11	15	18.5
Supplied active power [hp] at rated value of output voltage and at line voltage 600 V					
• with low overload	hp	10	15	20	25
• with high overload	hp	10	10	15	20
Pulse frequency	kHz	2	2	2	2
Efficiency		0.973	0.975	0.976	0.976
Power loss <sup>1)</sup>	kW	0.359	0.452	0.533	0.614
Cooling air flow	m <sup>3</sup> /s (ft <sup>3</sup> /h)	0.055 (6992.30465)	0.055 (6992.30465)	0.055 (6992.30465)	0.055 (6992.30465)
1 m measuring surface sound pressure level maximum	dB	70	70	70	70
Input current at line voltage 690 V					
• with low overload rated value	A	14	18	22	25
• with high overload rated value	A	12.1	14.6	20	23.4
for mains supply line					
• Type of electrical connection		Screw-type terminals	Screw-type terminals	Screw-type terminals	Screw-type terminals
• Number of connections		1	1	1	1
• Connectable conductor cross-section	mm <sup>2</sup>	10 ... 35	10 ... 35	10 ... 35	10 ... 35
• as coded connectable conductor cross section		AWG 8 ... AWG 2	AWG 8 ... AWG 2	AWG 8 ... AWG 2	AWG 8 ... AWG 2
for motor supply line					
• Type of electrical connection		Screw-type terminals	Screw-type terminals	Screw-type terminals	Screw-type terminals
• Number of connections		1	1	1	1
• Connectable conductor cross-section	mm <sup>2</sup>	10 ... 35	10 ... 35	10 ... 35	10 ... 35
• as coded connectable conductor cross section		AWG 8 ... AWG 2	AWG 8 ... AWG 2	AWG 8 ... AWG 2	AWG 8 ... AWG 2
Type of electrical connection for PE conductor		Screw-type terminals	Screw-type terminals	Screw-type terminals	Screw-type terminals
Cable length for motor					
• shielded maximum <sup>2)</sup>	m (ft)	200 (656.16798)	200 (656.16798)	200 (656.16798)	200 (656.16798)
• unshielded maximum <sup>2)</sup>	m (ft)	300 (984.25197)	300 (984.25197)	300 (984.25197)	300 (984.25197)
Dimensions					
• Width	mm (in)	200 (7.87402)	200 (7.87402)	200 (7.87402)	200 (7.87402)
• Height	mm (in)	472 (18.58268)	472 (18.58268)	472 (18.58268)	472 (18.58268)
• Depth	mm (in)	239 (9.40945)	239 (9.40945)	239 (9.40945)	239 (9.40945)
• Depth, with operator panel	mm (in)	248 (9.76378)	248 (9.76378)	248 (9.76378)	248 (9.76378)
Frame size		FSD	FSD	FSD	FSD
Weight, approx. <sup>3)</sup>	kg (lb)	16.6 (36.59669)	16.6 (36.59669)	16.6 (36.59669)	16.6 (36.59669)

<sup>1)</sup> Typical values acc. to IEC 61800-9-2.  
More information can be found on the internet at  
<https://support.industry.siemens.com/cs/document/94059311>

<sup>2)</sup> The values apply without compliance to the EMC category.  
For more information, see Maximum permissible motor cable lengths  
SINAMICS G120X and on the internet at  
[www.siemens.com/sinamics-g120x/documentation](http://www.siemens.com/sinamics-g120x/documentation)

<sup>3)</sup> The values apply for converters without integrated line filter.  
For more information, see on the internet at  
[www.siemens.com/sinamics-g120x/documentation](http://www.siemens.com/sinamics-g120x/documentation)



# SINAMICS G120X infrastructure converters for HVAC/Water/Wastewater

0.75 kW to 630 kW (1 hp to 700 hp)

## SINAMICS G120X infrastructure converters for HVAC/Water/Wastewater

### Technical specifications

		6SL32.0-.YH34-.A.0 6SL32.0-.YH34-.U.0	6SL32.0-.YH36-.A.0 6SL32.0-.YH36-.U.0	6SL32.0-.YH38-.U.0 6SL32.0-.YH38-.A.0	6SL32.0-.YH40-.A.0 6SL32.0-.YH40-.U.0
Type of voltage		3 AC	3 AC	3 AC	3 AC
Line voltage	V	500 ... 690	500 ... 690	500 ... 690	500 ... 690
Output current at line voltage 690 V					
• without overload rated value	A	36	43	54	64
• with low overload rated value	A	35	42	52	62
• with high overload rated value	A	27	35	42	52
• maximum	A	48	57	71	84
Supplied active power at rated value of output voltage and at line voltage 690 V					
• with low overload	kW	30	37	45	55
• with high overload	kW	22	30	37	45
Supplied active power [hp] at rated value of output voltage and at line voltage 600 V					
• with low overload	hp	30	40	50	60
• with high overload	hp	25	30	40	50
Pulse frequency	kHz	2	2	2	2
Efficiency		0.976	0.976	0.978	0.978
Power loss <sup>1)</sup>	kW	0.797	0.971	1.11	1.35
Cooling air flow	m <sup>3</sup> /s (ft <sup>3</sup> /h)	0.055 (6992.30465)	0.055 (6992.30465)	0.083 (10552.02338)	0.083 (10552.02338)
1 m measuring surface sound pressure level maximum	dB	70	70	70	70
Input current at line voltage 690 V					
• with low overload rated value	A	33	40	50	59
• with high overload rated value	A	28	36.6	44.4	54.4
for mains supply line					
• Type of electrical connection		Screw-type terminals	Screw-type terminals	Screw-type terminals	Screw-type terminals
• Number of connections		1	1	1	1
• Connectable conductor cross-section	mm <sup>2</sup>	10 ... 35	10 ... 35	25 ... 70	25 ... 70
• as coded connectable conductor cross section		AWG 8 ... AWG 2	AWG 8 ... AWG 2	AWG 6 ... AWG 3/0	AWG 6 ... AWG 3/0
for motor supply line					
• Type of electrical connection		Screw-type terminals	Screw-type terminals	Screw-type terminals	Screw-type terminals
• Number of connections		1	1	1	1
• Connectable conductor cross-section	mm <sup>2</sup>	10 ... 35	10 ... 35	25 ... 70	25 ... 70
• as coded connectable conductor cross section		AWG 8 ... AWG 2	AWG 8 ... AWG 2	AWG 6 ... AWG 3/0	AWG 6 ... AWG 3/0
Type of electrical connection for PE conductor		Screw-type terminals	Screw-type terminals	Screw-type terminals	Screw-type terminals
Cable length for motor					
• shielded maximum <sup>2)</sup>	m (ft)	200 (656.16798)	300 (984.25197)	300 (984.25197)	300 (984.25197)
• unshielded maximum <sup>2)</sup>	m (ft)	300 (984.25197)	450 (1476.37795)	450 (1476.37795)	450 (1476.37795)
Dimensions					
• Width	mm (in)	200 (7.87402)	200 (7.87402)	275 (10.82677)	275 (10.82677)
• Height	mm (in)	472 (18.58268)	472 (18.58268)	551 (21.69291)	551 (21.69291)
• Depth	mm (in)	239 (9.40945)	239 (9.40945)	239 (9.40945)	239 (9.40945)
• Depth, with operator panel	mm (in)	248 (9.76378)	248 (9.76378)	248 (9.76378)	248 (9.76378)
Frame size		FSD	FSD	FSE	FSE
Weight, approx. <sup>3)</sup>	kg (lb)	16.6 (36.59669)	18.8 (41.44686)	26.7 (58.86342)	26.7 (58.86342)

<sup>1)</sup> Typical values acc. to IEC 61800-9-2.  
More information can be found on the internet at  
<https://support.industry.siemens.com/cs/document/94059311>

<sup>2)</sup> The values apply without compliance to the EMC category.  
For more information, see Maximum permissible motor cable lengths  
SINAMICS G120X and on the internet at  
[www.siemens.com/sinamics-g120x/documentation](http://www.siemens.com/sinamics-g120x/documentation)

<sup>3)</sup> The values apply for converters without integrated line filter.  
For more information, see on the internet at  
[www.siemens.com/sinamics-g120x/documentation](http://www.siemens.com/sinamics-g120x/documentation)

# SINAMICS G120X infrastructure converters for HVAC/Water/Wastewater

0.75 kW to 630 kW (1 hp to 700 hp)

## SINAMICS G120X infrastructure converters for HVAC/Water/Wastewater

### Technical specifications

		6SL32.0-.YH42-.C.0 6SL32.0-.YH42-.U.0	6SL32.0-.YH44-.C.0 6SL32.0-.YH44-.U.0	6SL32.0-.YH46-.C.0 6SL32.0-.YH46-.U.0	6SL32.0-.YH48-.C.0 6SL32.0-.YH48-.U.0
Type of voltage		3 AC	3 AC	3 AC	3 AC
Line voltage	V	500 ... 690	500 ... 690	500 ... 690	500 ... 690
Output current at line voltage 690 V					
• without overload rated value	A	82	103	128	148
• with low overload rated value	A	80	100	125	144
• with high overload rated value	A	62	80	100	125
• maximum	A	108	135	169	195
Supplied active power at rated value of output voltage and at line voltage 690 V					
• with low overload	kW	75	90	110	132
• with high overload	kW	55	75	90	110
Supplied active power [hp] at rated value of output voltage and at line voltage 600 V					
• with low overload	hp	75	100	125	150
• with high overload	hp	60	75	100	125
Pulse frequency	kHz	2	2	2	2
Efficiency		0.982	0.981	0.982	0.981
Power loss <sup>1)</sup>	kW	1.41	1.80	2.22	2.64
Cooling air flow	m <sup>3</sup> /s (ft <sup>3</sup> /h)	0.153 (19451.32021)	0.153 (19451.32021)	0.153 (19451.32021)	0.153 (19451.32021)
1 m measuring surface sound pressure level maximum	dB	72	72	72	72
Input current at line voltage 690 V					
• with low overload rated value	A	78	97	121	138
• with high overload rated value	A	66.4	85.2	106.3	131.6
for mains supply line					
• Type of electrical connection		M10 screw	M10 screw	M10 screw	M10 screw
• Number of connections		2	2	2	2
• Connectable conductor cross-section	mm <sup>2</sup>	35 ... 120	35 ... 120	35 ... 120	35 ... 120
• as coded connectable conductor cross section		AWG 1 ... AWG 2 × 4/0	AWG 1 ... AWG 2 × 4/0	AWG 1 ... AWG 2 × 4/0	AWG 1 ... AWG 2 × 4/0
for motor supply line					
• Type of electrical connection		M10 screw	M10 screw	M10 screw	M10 screw
• Number of connections		2	2	2	2
• Connectable conductor cross-section	mm <sup>2</sup>	35 ... 120	35 ... 120	35 ... 120	35 ... 120
• as coded connectable conductor cross section		AWG 1 ... AWG 2 × 4/0	AWG 1 ... AWG 2 × 4/0	AWG 1 ... AWG 2 × 4/0	AWG 1 ... AWG 2 × 4/0
Type of electrical connection for PE conductor		M10 screw	M10 screw	M10 screw	M10 screw
Cable length for motor					
• shielded maximum <sup>2)</sup>	m (ft)	300 (984.25197)	300 (984.25197)	300 (984.25197)	300 (984.25197)
• unshielded maximum <sup>2)</sup>	m (ft)	450 (1476.37795)	450 (1476.37795)	450 (1476.37795)	450 (1476.37795)
Dimensions					
• Width	mm (in)	305 (12.00787)	305 (12.00787)	305 (12.00787)	305 (12.00787)
• Height	mm (in)	709 (27.91339)	709 (27.91339)	709 (27.91339)	709 (27.91339)
• Depth	mm (in)	360 (14.17323)	360 (14.17323)	360 (14.17323)	360 (14.17323)
• Depth, with operator panel	mm (in)	369 (14.52756)	369 (14.52756)	369 (14.52756)	369 (14.52756)
Frame size		FSF	FSF	FSF	FSF
Weight, approx. <sup>3)</sup>	kg (lb)	61 (134.48182)	61 (134.48182)	66.5 (146.60723)	66.5 (146.60723)

<sup>1)</sup> Typical values acc. to IEC 61800-9-2.  
More information can be found on the internet at  
<https://support.industry.siemens.com/cs/document/94059311>

<sup>2)</sup> The values apply without compliance to the EMC category.  
For more information, see Maximum permissible motor cable lengths  
SINAMICS G120X and on the internet at  
[www.siemens.com/sinamics-g120x/documentation](http://www.siemens.com/sinamics-g120x/documentation)

<sup>3)</sup> The values apply for converters without integrated line filter.  
For more information, see on the internet at  
[www.siemens.com/sinamics-g120x/documentation](http://www.siemens.com/sinamics-g120x/documentation)

## SINAMICS G120X infrastructure converters for HVAC/Water/Wastewater

0.75 kW to 630 kW (1 hp to 700 hp)

### SINAMICS G120X infrastructure converters for HVAC/Water/Wastewater

#### Technical specifications

		6SL32.0-.YH50-.C.0	6SL32.0-.YH52-.C.0	6SL32.0-.YH54-.C.0	6SL3220-.YH56-.C.0	6SL3220-.YH58-.C.0
Type of voltage		3 AC	3 AC	3 AC	3 AC	3 AC
Line voltage	V	500 ... 690	500 ... 690	500 ... 690	500 ... 690	500 ... 690
Output current at line voltage 690 V						
• without overload rated value	A	175	213	256	368	400
• with low overload rated value	A	171	208	250	330	385
• with high overload rated value	A	144	171	208	272	314
• maximum	A	231	281	338	487	529
Supplied active power at rated value of output voltage and at line voltage 690 V						
• with low overload	kW	160	200	250	315	355
• with high overload	kW	132	160	200	250	315
Supplied active power [hp] at rated value of output voltage and at line voltage 600 V						
• with low overload	hp	150	200	250	350	400
• with high overload	hp	150	150	200	250	300
Pulse frequency	kHz	2	2	2	2	2
Efficiency		0.982	0.982	0.981	0.982	0.982
Power loss <sup>1)</sup>	kW	2.93	3.70	4.63	5.88	6.91
Cooling air flow	m <sup>3</sup> /s (ft <sup>3</sup> /h)	0.21 (26697.89049)	0.21 (26697.89049)	0.21 (26697.89049)	0.362 (46022.07788)	0.362 (46022.07788)
1 m measuring surface sound pressure level maximum	dB	74	74	74	74	74
Input current at line voltage 690 V						
• with low overload rated value	A	171	205	249	343	401
• with high overload rated value	A	158.2	185.1	227.5	283	327
for mains supply line						
• Type of electrical connection		M10 screw	M10 screw	M10 screw	M12 screw	M12 screw
• Number of connections		2	2	2	4	4
• Connectable conductor cross-section	mm <sup>2</sup>	35 ... 185	35 ... 185	35 ... 185	240 ... 240	240 ... 240
• as coded connectable conductor cross section		AWG 1 ... MCM 2 × 350	AWG 1 ... MCM 2 × 350	AWG 1 ... MCM 2 × 350	MCM 2 × 500 ... MCM 4 × 500	MCM 2 × 500 ... MCM 4 × 500
for motor supply line						
• Type of electrical connection		M10 screw	M10 screw	M10 screw	M12 screw	M12 screw
• Number of connections		2	2	2	4	4
• Connectable conductor cross-section	mm <sup>2</sup>	35 ... 185	35 ... 185	35 ... 185	240 ... 240	240 ... 240
• as coded connectable conductor cross section		AWG 1 ... MCM 2 × 350	AWG 1 ... MCM 2 × 350	AWG 1 ... MCM 2 × 350	MCM 2 × 500 ... MCM 4 × 500	MCM 2 × 500 ... MCM 4 × 500
Type of electrical connection for PE conductor		M10 screw	M10 screw	M10 screw	M12 screw	M12 screw
Cable length for motor						
• shielded maximum <sup>2)</sup>	m (ft)	150 (492.12598)	150 (492.12598)	150 (492.12598)	150 (492.12598)	150 (492.12598)
Dimensions						
• Width	mm (in)	305 (12.00787)	305 (12.00787)	305 (12.00787)	548 (21.5748)	548 (21.5748)
• Height	mm (in)	999 (39.33071)	999 (39.33071)	999 (39.33071)	1695 (66.73228)	1695 (66.73228)
• Depth	mm (in)	360 (14.17323)	360 (14.17323)	360 (14.17323)	393 (15.47244)	393 (15.47244)
• Depth, with operator panel	mm (in)	369 (14.52756)	369 (14.52756)	369 (14.52756)	393 (15.47244)	393 (15.47244)
Frame size		FSG	FSG	FSG	FSH	FSH
Weight, approx.	kg (lb)	105 (231.48536)	113 (249.12234)	120 (264.5547)	158 (348.33035)	158 (348.33035)

<sup>1)</sup> Typical values acc. to IEC 61800-9-2.  
More information can be found on the internet at  
<https://support.industry.siemens.com/cs/document/94059311>

<sup>2)</sup> The values apply with compliance to the EMC category.  
For more information, see Maximum permissible motor cable lengths  
SINAMICS G120X and on the internet at  
[www.siemens.com/sinamics-g120x/documentation](http://www.siemens.com/sinamics-g120x/documentation)

# SINAMICS G120X infrastructure converters for HVAC/Water/Wastewater

0.75 kW to 630 kW (1 hp to 700 hp)

## SINAMICS G120X infrastructure converters for HVAC/Water/Wastewater

### Technical specifications

		6SL3220-YH60-C.0	6SL3220-YH62-C.0	6SL3220-YH64-C.0	6SL3220-YH66-C.0	6SL3220-YH68-C.0
Type of voltage		3 AC	3 AC	3 AC	3 AC	3 AC
Line voltage	V	500 ... 690	500 ... 690	500 ... 690	500 ... 690	500 ... 690
Output current at line voltage 690 V						
• without overload rated value	A	453	516	581	654	725
• with low overload rated value	A	420	470	520	580	650
• with high overload rated value	A	348	394	444	476	532
• maximum	A	598	682	768	864	959
Supplied active power at rated value of output voltage and at line voltage 690 V						
• with low overload	kW	400	450	500	560	630
• with high overload	kW	355	400	450	500	560
Supplied active power [hp] at rated value of output voltage and at line voltage 600 V						
• with low overload	hp	450	500	500	600	700
• with high overload	hp	350	450	450	500	500
Pulse frequency	kHz	2	2	2	2	2
Efficiency		0.982	0.981	0.982	0.982	0.982
Power loss <sup>1)</sup>	kW	7.67	8.84	9.18	10.4	11.4
Cooling air flow	m <sup>3</sup> /s (ft <sup>3</sup> /h)	0.362 (46022.07788)	0.362 (46022.07788)	0.45 (57209.76533)	0.45 (57209.76533)	0.45 (57209.76533)
1 m measuring surface sound pressure level maximum	dB	74	74	74	74	74
Input current at line voltage 690 V						
• with low overload rated value	A	437	489	540	602	675
• with high overload rated value	A	362	410	461	494	552
for mains supply line						
• Type of electrical connection		M12 screw	M12 screw	M12 screw	M12 screw	M12 screw
• Number of connections		4	4	6	6	6
• Connectable conductor cross-section	mm <sup>2</sup>	240 ... 240	240 ... 240	240 ... 240	240 ... 240	240 ... 240
• as coded connectable conductor cross section		MCM 2 × 500 ... MCM 4 × 500	MCM 2 × 500 ... MCM 4 × 500	MCM 4 × 500 ... MCM 6 × 500	MCM 4 × 500 ... MCM 6 × 500	MCM 4 × 500 ... MCM 6 × 500
for motor supply line						
• Type of electrical connection		M12 screw	M12 screw	M12 screw	M12 screw	M12 screw
• Number of connections		4	4	6	6	6
• Connectable conductor cross-section	mm <sup>2</sup>	240 ... 240	240 ... 240	240 ... 240	240 ... 240	240 ... 240
• as coded connectable conductor cross section		MCM 2 × 500 ... MCM 4 × 500	MCM 2 × 500 ... MCM 4 × 500	MCM 4 × 500 ... MCM 8 × 500	MCM 4 × 500 ... MCM 8 × 500	MCM 4 × 500 ... MCM 8 × 500
Type of electrical connection for PE conductor		M12 screw	M12 screw	M12 screw	M12 screw	M12 screw
Cable length for motor						
• shielded maximum <sup>2)</sup>	m (ft)	150 (492.12598)	150 (492.12598)	150 (492.12598)	150 (492.12598)	150 (492.12598)
Dimensions						
• Width	mm (in)	548 (21.5748)	548 (21.5748)	801 (31.53543)	801 (31.53543)	801 (31.53543)
• Height	mm (in)	1695 (66.73228)	1695 (66.73228)	1621 (63.8189)	1621 (63.8189)	1621 (63.8189)
• Depth	mm (in)	393 (15.47244)	393 (15.47244)	393 (15.47244)	393 (15.47244)	393 (15.47244)
• Depth, with operator panel	mm (in)	393 (15.47244)	393 (15.47244)	393 (15.47244)	393 (15.47244)	393 (15.47244)
Frame size		FSH	FSH	FSJ	FSJ	FSJ
Weight, approx.	kg (lb)	162 (357.14884)	162 (357.14884)	236 (520.2909)	236 (520.2909)	246 (542.33713)

<sup>1)</sup> Typical values acc. to IEC 61800-9-2.  
More information can be found on the internet at  
<https://support.industry.siemens.com/cs/document/94059311>

<sup>2)</sup> The values apply with compliance to the EMC category.  
For more information, see Maximum permissible motor cable lengths  
SINAMICS G120X and on the internet at  
[www.siemens.com/sinamics-g120x/documentation](http://www.siemens.com/sinamics-g120x/documentation)

## SINAMICS G120X infrastructure converters for HVAC/Water/Wastewater

0.75 kW to 630 kW (1 hp to 700 hp)

### SINAMICS G120X infrastructure converters for HVAC/Water/Wastewater

#### Characteristic curves

##### Derating data

##### Pulse frequency

Frame size	Rated power <sup>1)</sup> at 50 Hz 200 V 3 AC		Rated output current <sup>2)</sup> in A (at an ambient temperature of 45 °C (113 °F)) for a pulse frequency of							
	kW	hp	2 kHz	4 kHz	6 kHz	8 kHz	10 kHz	12 kHz	14 kHz	16 kHz
FSA	0.75	1	4.2	<b>4.2</b>	3.5	2.9	2.5	2.1	1.8	1.6
	1.1	1.5	6	<b>6</b>	5.1	4.2	3.6	3	2.7	2.4
	1.5	2	7.4	<b>7.4</b>	6.2	5.1	4.4	3.7	3.3	2.9
FSB	2.2	3	10.4	<b>10.4</b>	8.8	7.2	6.2	5.2	4.6	4.1
	3	4	13.6	<b>13.6</b>	11.5	9.5	8.1	6.8	6.1	5.4
	4	5	17.5	<b>17.5</b>	14.8	12.2	10.4	8.7	7.8	7
FSC	5.5	7.5	22	<b>22</b>	18.7	15.4	13.2	11	9.9	8.8
	7.5	10	28	<b>28</b>	23.8	19.6	16.8	14	12.6	11.2
FSD	11	15	42	<b>42</b>	35.7	29.4	25.2	21	18.9	16.8
	15	20	54	<b>54</b>	45.9	37.8	32.4	27	24.3	21.6
	18.5	25	68	<b>68</b>	57.8	47.6	40.8	34	30.6	27.2
FSE	22	30	80	<b>80</b>	68	56	48	40	36	32
	30	40	104	<b>104</b>	88.4	72.8	62.4	52	46.8	41.6
FSF	37	50	130	<b>130</b>	110.5	91	78	65	58.5	52
	45	60	154	<b>154</b>	130.8	107.8	92.4	77	69.3	61.6
	55	75	192	<b>192</b>	163.2	134.4	115.2	96	86.4	76.8

The rated output currents in **bold** apply for the standard pulse frequency.

<sup>1)</sup> Rated power based on the base-load current  $I_L$ .  
The base-load current  $I_L$  is based on the duty cycle for low overload (LO).

<sup>2)</sup> Output current based on the base-load current  $I_L$ .  
The base-load current  $I_L$  is based on the duty cycle for low overload (LO).

## SINAMICS G120X infrastructure converters for HVAC/Water/Wastewater

0.75 kW to 630 kW (1 hp to 700 hp)

### SINAMICS G120X infrastructure converters for HVAC/Water/Wastewater

#### Characteristic curves

Frame size	Rated power <sup>1)</sup> at 50 Hz 400 V 3 AC		Rated output current <sup>2)</sup> in A (at an ambient temperature of 45 °C (113 °F)) for a pulse frequency of							
	kW	hp	2 kHz	4 kHz	6 kHz	8 kHz	10 kHz	12 kHz	14 kHz	16 kHz
FSA	0.75	1	2.2	<b>2.2</b>	1.87	1.54	1.32	1.1	0.99	0.88
	1.1	1.5	3.1	<b>3.1</b>	2.635	2.17	1.86	1.55	1.395	1.24
	1.5	2	4.1	<b>4.1</b>	3.485	2.87	2.46	2.05	1.895	1.64
	2.2	3	5.9	<b>5.9</b>	5.015	4.13	3.54	2.95	2.655	2.36
	3	4	7.7	<b>7.7</b>	6.545	5.39	4.62	3.85	3.465	3.08
FSB	4	5	10.2	<b>10.2</b>	8.67	7.14	6.12	5.1	4.59	4.08
	5.5	7.5	13.2	<b>13.2</b>	11.22	9.24	7.92	6.6	5.94	5.28
	7.5	10	18	<b>18</b>	15.3	12.6	10.8	9	8.1	7.2
FSC	11	15	26	<b>26</b>	22.1	18.2	15.6	13	11.7	10.4
	15	20	32	<b>32</b>	27.2	22.4	19	18	14.4	12.8
FSD	18.5	25	38	<b>38</b>	32.3	26.6	22.8	19	17.1	15.2
	22	30	45	<b>45</b>	38.2	31.5	27	22.5	20.2	18
	30	40	60	<b>60</b>	51	42	36	30	27	24
	37	50	75	<b>75</b>	63.7	52.5	45	37.5	33.7	30
FSE	45	60	90	<b>90</b>	76.5	63	54	45	40.5	36
	55	75	110	<b>110</b>	93.5	77	66	55	49.5	44
FSF	75	100	145	<b>145</b>	123.2	101.5	87	72.5	65.2	58
	90	125	178	<b>178</b>	151	124.6	107	89	80.1	71.2
	110	150	<b>205</b>	143.5	103	82	–	–	–	–
	132	200	<b>250</b>	175	125	100	–	–	–	–
FSG	160	250	<b>302</b>	211.4	151	121	–	–	–	–
	200	300	<b>370</b>	259	185	148	–	–	–	–
	250	400	<b>477</b>	334	239	191	–	–	–	–
FSH <sup>3)</sup>	315	400	<b>585</b>	468	–	–	–	–	–	–
	355	450	<b>655</b>	524	–	–	–	–	–	–
	400	500	<b>735</b>	588	–	–	–	–	–	–
FSJ <sup>3)</sup>	450	500	<b>840</b>	672	–	–	–	–	–	–
	500	600	<b>910</b>	728	–	–	–	–	–	–
	560	700	<b>1021</b>	817	–	–	–	–	–	–

The rated output currents in **bold** apply for the standard pulse frequency.

<sup>1)</sup> Rated power based on the base-load current  $I_L$ .  
The base-load current  $I_L$  is based on the duty cycle for low overload (LO).

<sup>2)</sup> Frame sizes FSA to FSG:  
Output current based on the base-load current  $I_L$ . The base-load current  $I_L$  is based on the duty cycle for low overload (LO). Frame sizes FSH and FSJ:  
Output current based on the rated output current  $I_N$ . The rated output current  $I_N$  can be used up to 100 %; however, without overload.

<sup>3)</sup> In the factory setting, these converters start at a pulse frequency of 4 kHz and reduce it automatically under load to the associated required frequencies. As the load decreases, the pulse frequency increases automatically up to 4 kHz.



## SINAMICS G120X infrastructure converters for HVAC/Water/Wastewater

0.75 kW to 630 kW (1 hp to 700 hp)

### SINAMICS G120X infrastructure converters for HVAC/Water/Wastewater

#### Characteristic curves

Frame size	Rated power <sup>1)</sup> at 50 Hz 690 V 3 AC		Rated output current in A (at an ambient temperature of 45 °C (113 °F)) for a pulse frequency of							
	kW	hp	2 kHz	4 kHz	6 kHz	8 kHz	10 kHz	12 kHz	14 kHz	16 kHz
FSD	3	4	<b>6</b>	3.6	–	–	–	–	–	–
	4	5	<b>7</b>	4.2	–	–	–	–	–	–
	5.5	7.5	<b>10</b>	6	–	–	–	–	–	–
	7.5	10	<b>13</b>	7.8	–	–	–	–	–	–
	11	10	<b>16</b>	9.6	–	–	–	–	–	–
	15	15	<b>21</b>	12.6	–	–	–	–	–	–
	18.5	20	<b>25</b>	15	–	–	–	–	–	–
	22	25	<b>29</b>	17.4	–	–	–	–	–	–
	30	30	<b>38</b>	22.8	–	–	–	–	–	–
	37	40	<b>46</b>	27.6	–	–	–	–	–	–
FSE	45	50	<b>58</b>	34.8	–	–	–	–	–	–
	55	60	<b>68</b>	40.8	–	–	–	–	–	–
FSF	75	75	<b>90</b>	54	–	–	–	–	–	–
	90	100	<b>112</b>	67.2	–	–	–	–	–	–
	110	125	<b>128</b>	76.8	–	–	–	–	–	–
	132	150	<b>158</b>	94.8	–	–	–	–	–	–
FSG	160	150	<b>196</b>	118	–	–	–	–	–	–
	200	200	<b>236</b>	142	–	–	–	–	–	–
	250	250	<b>288</b>	173	–	–	–	–	–	–
FSH <sup>2)</sup>	315	350	<b>330</b>	215	–	–	–	–	–	–
	355	400	<b>385</b>	250	–	–	–	–	–	–
	400	450	<b>420</b>	273	–	–	–	–	–	–
	450	500	<b>470</b>	306	–	–	–	–	–	–
FSJ <sup>2)</sup>	500	500	<b>520</b>	338	–	–	–	–	–	–
	560	600	<b>580</b>	377	–	–	–	–	–	–
	630	700	<b>650</b>	423	–	–	–	–	–	–

The rated output currents in **bold** apply for the standard pulse frequency.

<sup>1)</sup> Rated power based on the base-load current  $I_L$ .  
The base-load current  $I_L$  is based on the duty cycle for low overload (LO).

<sup>2)</sup> In the factory setting, these converters start at a pulse frequency of 4 kHz and reduce it automatically under load to the associated required frequencies. As the load decreases, the pulse frequency increases automatically up to 4 kHz. The values of the rated currents apply to a pulse frequency of 2 kHz and are reached at any time by automatic adaptation of the output pulse frequency.

# SINAMICS G120X infrastructure converters for HVAC/Water/Wastewater

0.75 kW to 630 kW (1 hp to 700 hp)

## SINAMICS G120X infrastructure converters for HVAC/Water/Wastewater

### Characteristic curves

#### Ambient temperature

##### Frame sizes FSA to FSG:

- Variant PROFINET, Ethernet/IP:

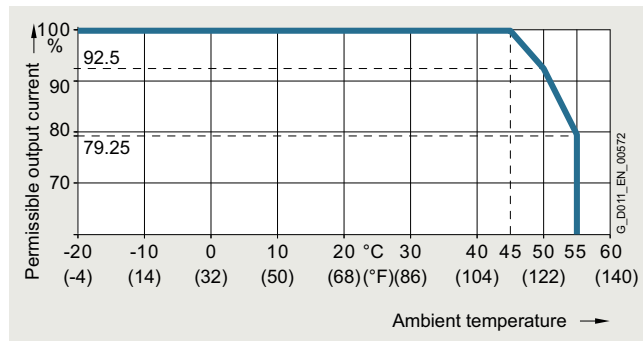

Permissible output current as a function of ambient temperature for SINAMICS G120X, frame sizes FSA to FSG, at low overload (LO)

- Variants PROFIBUS DP and USS, Modbus RTU, BACnet MS/TP:

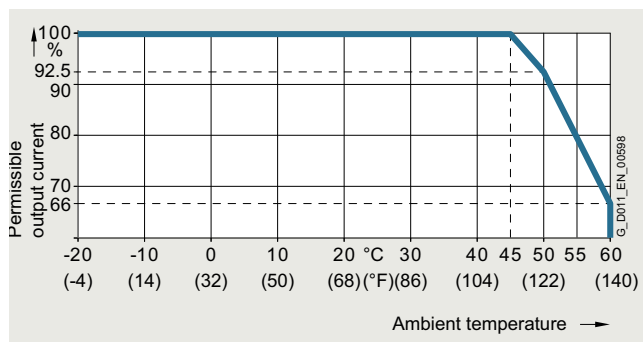

Permissible output current as a function of ambient temperature for SINAMICS G120X, frame sizes FSA to FSG, at low overload (LO)

##### Frame sizes FSH and FSJ:

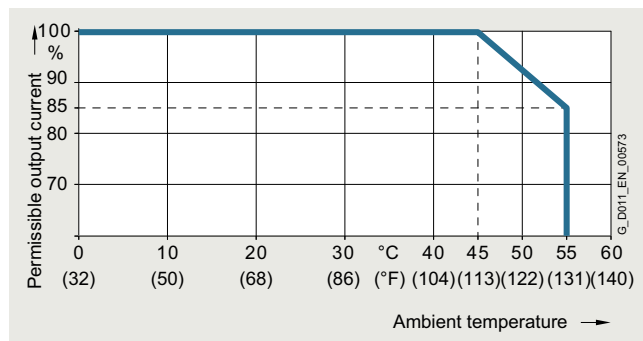

Permissible output current as a function of ambient temperature for SINAMICS G120X, frame sizes FSH and FSJ, at low overload (LO)

The operating temperature ranges of the operator panels should be taken into account. The temperature ranges are specified in the Technical specifications section under Operator panels.

#### Installation altitude

##### Frame sizes FSA to FSJ:

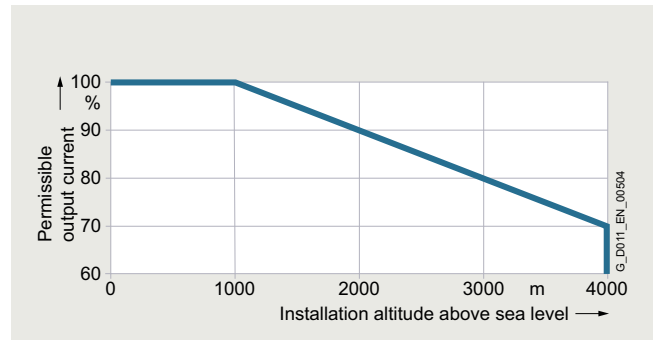

Permissible output current as a function of installation altitude for SINAMICS G120X at low overload (LO) at an ambient temperature of 45 °C (113 °F), derating 70 % at 4000 m (13124 ft)

The connected motors, power elements and components must be considered separately.

Permissible line supplies as a function of the installation altitude

- Installation altitude up to 2000 m (6562 ft) above sea level
  - Connection to every supply system permitted for the converter
- Installation altitudes between 2000 m (6562 ft) and 4000 m (13124 ft) above sea level
  - Connection only to a TN system with grounded neutral point
  - TN systems with grounded line conductor are not permitted
  - The TN line system with grounded neutral point can also be supplied using an isolation transformer
  - The phase-to-phase voltage does not have to be reduced

When using converters on TN systems with voltages  $\geq 600$  V and at installation altitudes of 2000 m to 4000 m, the TN line supply must have a grounded neutral point established using an isolation transformer.

# SINAMICS G120X infrastructure converters for HVAC/Water/Wastewater

0.75 kW to 630 kW (1 hp to 700 hp)

## SINAMICS G120X infrastructure converters for HVAC/Water/Wastewater

### Characteristic curves

#### System operating voltage

#### 200 V converters frame sizes FSA to FSF:

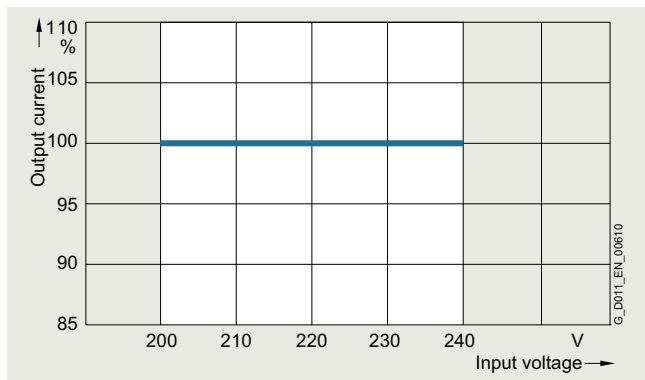

Permissible output current as a function of the input voltage for 200 V SINAMICS G120X converters, frame sizes FSA to FSF

#### 400 V converters frame sizes FSH and FSJ:

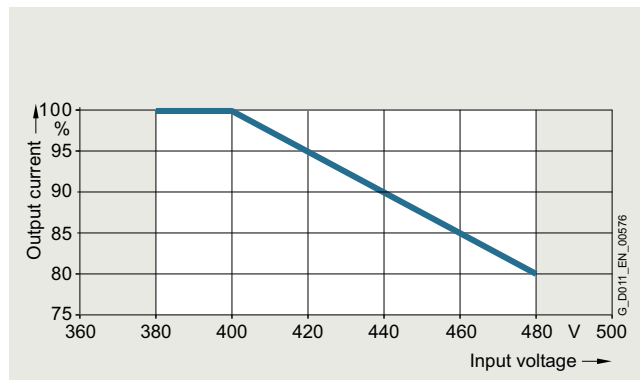

Permissible output current as a function of input voltage for 400 V SINAMICS G120X converters, frame sizes FSH and FSJ, at low overload (LO)

#### 400 V converters frame sizes FSA to FSG:

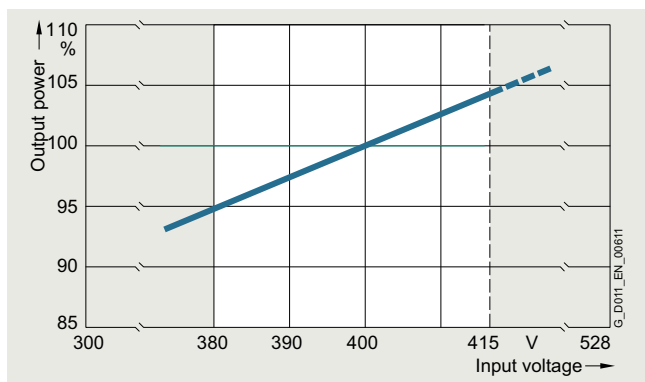

Permissible output power as a function of the input voltage for 400 V SINAMICS G120X converters, frame sizes FSA to FSG, at 100% output current in the range of 380 V to 415 V (the temperature protection of the converter can reduce the current or pulse frequency above 415 V)

#### 600 V converters frame sizes FSA to FSG:

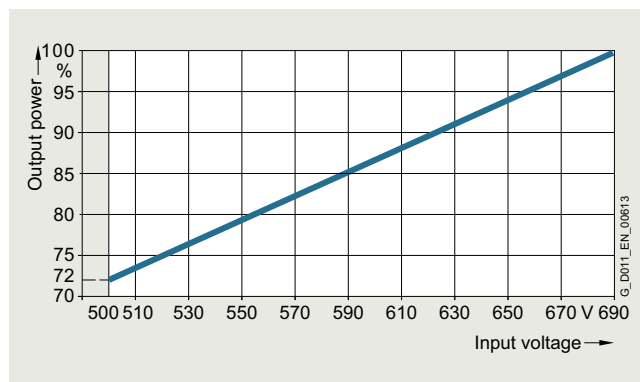

Permissible output power as a function of input voltage for 600 V SINAMICS G120X converters, frame sizes FSA to FSG, at 100% output current in the range of 500 V to 690 V

Further information is available in the manual on the internet at: [www.siemens.com/sinamics-g120x/documentation](http://www.siemens.com/sinamics-g120x/documentation)

#### 600 V converters frame sizes FSH and FSJ:

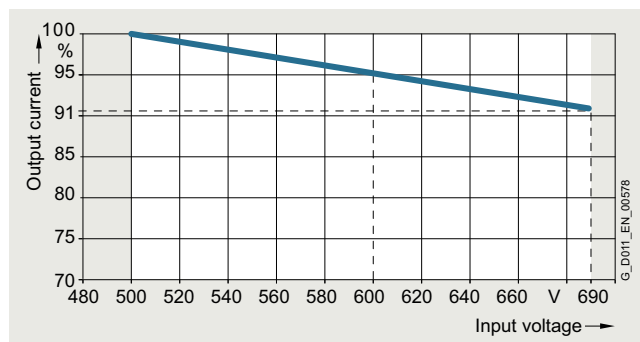

Permissible output current as a function of input voltage for 600 V SINAMICS G120X converters, frame sizes FSH and FSJ, at low overload (LO)

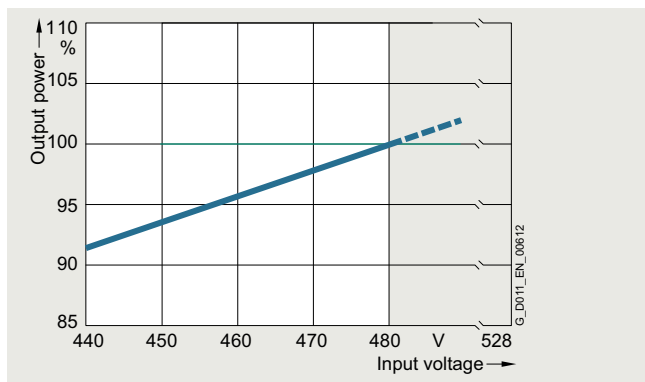

Permissible output power as a function of the input voltage for 400 V SINAMICS G120X converters, frame sizes FSA to FSG, at 100% output current in the range of 440 V to 480 V (the temperature protection of the converter can reduce the current or pulse frequency above 480 V)

Further information is available in the manual on the internet at: [www.siemens.com/sinamics-g120x/documentation](http://www.siemens.com/sinamics-g120x/documentation)

# SINAMICS G120X infrastructure converters for HVAC/Water/Wastewater

0.75 kW to 630 kW (1 hp to 700 hp)

## SINAMICS G120X infrastructure converters for HVAC/Water/Wastewater

### Dimensional drawings

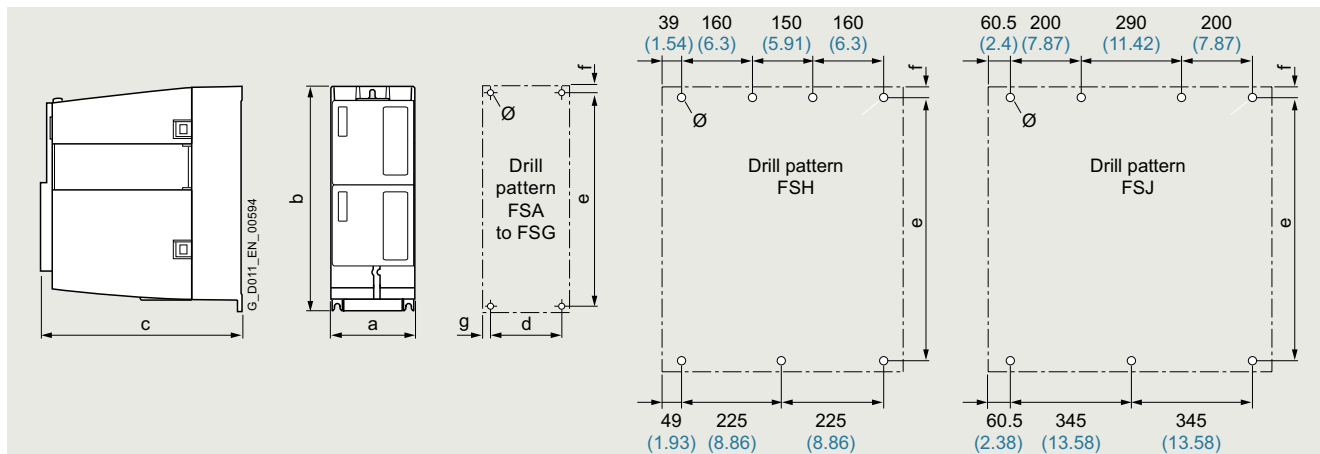

Principle dimension drawing and drill pattern for SINAMICS G120X

Frame size	Dimensions in mm (inches)			Drilling dimensions in mm (inches)					Mounting	Cooling clearance <sup>2)</sup> in mm (inches)		
	a (width)	b (height)	c (depth) <sup>1)</sup>	d	e	f	g	Ø		With screws (plus washers and nuts)	top	bottom
FSA	73 (2.87)	232 (9.13)	209 (8.23)	55 (2.17)	221.5 (8.72)	5.5 (0.22)	9 (0.35)	5 (0.2)	4 × M4	80 (3.15)	100 (3.94)	0 (0)
FSB	100 (3.94)	275 (10.83)	209 (8.23)	80 (3.15)	265 (10.43)	7 (0.28)	10 (0.39)	5 (0.2)	4 × M4	80 (3.15)	100 (3.94)	0 (0)
FSC	140 (5.51)	295 (11.61)	209 (8.23)	118 (4.65)	283 (11.14)	7 (0.28)	11 (0.43)	5.5 (0.22)	4 × M5	80 (3.15)	100 (3.94)	0 (0)
FSD	200 (7.87)	472 (18.58)	239 (9.41)	170 (6.69)	430 (16.93)	15 (0.59)	15 (0.59)	6 (0.24)	4 × M5	300 (11.81)	350 (13.78)	0 (0)
FSE	275 (10.83)	551 (21.69)	239 (9.41)	230 (9.06)	509 (20.04)	11 (0.43)	22.5 (0.89)	6.5 (0.26)	4 × M6	300 (11.81)	350 (13.78)	0 (0)
FSF	305 (12.01)	709 (27.91)	360 (14.17)	270 (10.63)	680 (26.77)	16.6 (0.65)	17.5 (0.69)	8.5 (0.33)	4 × M8	300 (11.81)	350 (13.78)	0 (0)
FSG	305 (12.01)	999 (39.33)	360 (14.17)	265 (10.43)	970.5 (38.21)	18.5 (0.73)	20 (0.79)	12 (0.47)	4 × M10	300 (11.81)	350 (13.78)	0 (0)
FSH	548 (21.57)	1695 (66.73)	393 (15.47)	see above	1419 (55.87)	21 (0.83)	see above	20 (0.79)	7 × M8	0 (0)	250 (9.84)	100 (3.94)
FSJ	801 (31.54)	1621 (63.82)	393 (15.47)	see above	1399 (55.08)	21 (0.83)	see above	20 (0.79)	7 × M8	0 (0)	250 (9.84)	100 (3.94)

### More information

Further documentation, such as the operating instructions, is available free on the internet at:

[www.siemens.com/sinamics-g120x/documentation](http://www.siemens.com/sinamics-g120x/documentation)

Detailed information on the SINAMICS G120X infrastructure converters for HVAC/Water/Wastewater, including the latest technical documentation (brochures, tutorials, dimensional drawings, certificates and operating instructions), is available on the internet at:

[www.siemens.com/sinamics-g120x](http://www.siemens.com/sinamics-g120x)

and is also available via the Siemens Product Configurator on the internet.

The Siemens Product Configurator can be found in SiePortal at the following address:

[www.siemens.com/spc](http://www.siemens.com/spc)

<sup>1)</sup> Increased depth for frame sizes FSA to FSG:

- When the operator panel is plugged on, the depth increases by 9 mm (0.35 in)
- When SINAMICS G120 Smart Access is plugged on, the depth increases by 7 mm (0.28 in)
- When the I/O Extension Module is plugged on, the depth increases by 27 mm (1.06 in)
  - when, in addition, the operator panel is plugged on, the depth increases by a further 11.8 mm (0.46 in)
  - when, in addition, SINAMICS G120 Smart Access is plugged on, the depth increases by a further 9.8 mm (0.39 in)

<sup>2)</sup> The converters in frame sizes FSA to FSG can be mounted side by side. A side clearance of 1 mm (0.04 in) is recommended for tolerance-related reasons. A side clearance of 30 mm (1.18 in) is required between the converters for frame sizes FSH and FSJ.

# SINAMICS G120X infrastructure converters for HVAC/Water/Wastewater

0.75 kW to 630 kW (1 hp to 700 hp)

## Supplementary system components > Operator panels

### Overview

Operator panel	IOP-2 and IOP-2 Handheld Intelligent Operator Panel	BOP-2 Basic Operator Panel
Description	 <p>Thanks to the high-contrast color display, menu-based operation and the wizards, commissioning of the standard drives is easy. Application wizards guide the user through the commissioning of important applications such as pumps, fans, compressors, or conveyor systems.</p>	 <p>Commissioning of standard drives is easy with the menu-prompted dialog on a 2-line display. Simultaneous display of the parameter and parameter value, as well as parameter filtering, means that basic commissioning of a drive can be performed easily and, in most cases, without a printed parameter list.</p>
Possible applications	<ul style="list-style-type: none"> <li>• Can be mounted directly on the converter</li> <li>• Can be mounted in a control cabinet door using a door mounting kit (achievable degree of protection is IP55/UL Type 12 enclosure)</li> <li>• Environmental class/harmful chemical substances Class 3C3 acc. to IEC 60721-3-3: 2002</li> <li>• Available as handheld version</li> <li>• The following languages are integrated in the IOP-2: English, German, French, Italian, Spanish, Portuguese, Dutch, Swedish, Finnish, Russian, Czech, Polish, Turkish, Chinese Simplified</li> </ul>	<ul style="list-style-type: none"> <li>• Can be mounted directly on the converter</li> <li>• Can be mounted in the control cabinet door using a door mounting kit (achievable degree of protection is IP55/UL Type 12)</li> <li>• Environmental class/harmful chemical substances Class 3C3 acc. to IEC 60721-3-3: 2002</li> </ul>
Quick commissioning without expert knowledge	<ul style="list-style-type: none"> <li>• Standard commissioning using the clone function</li> <li>• For quicker access, the parameter block names can be directly entered respectively changed on the IOP-2 using the virtual keyboard.</li> <li>• User-defined parameter list with a reduced number of self-selected parameters</li> <li>• Simple commissioning of standard applications using Quick Startup and Advanced Startup; it is not necessary to know the parameter structure</li> <li>• Simple local commissioning using the handheld version</li> <li>• Commissioning is possible largely without documentation</li> </ul>	<ul style="list-style-type: none"> <li>• Standard commissioning using the clone function</li> </ul>
High degree of operator friendliness and intuitive operation	<ul style="list-style-type: none"> <li>• Intuitive navigation by operating with a sensor control field</li> <li>• Graphic color display to show status values such as pressure or flow rate in the form of scalar values, bar-type diagrams, or trend displays</li> <li>• Status display with freely selectable units to specify physical values</li> <li>• Direct manual operation of the drive – you can simply toggle between the automatic and manual modes</li> <li>• Simple cloning of specific settings of the IOP-2 user interface.</li> </ul>	<ul style="list-style-type: none"> <li>• 2-line display for showing up to 2 process values with text</li> <li>• Status display of predefined units</li> <li>• Direct manual operation of the drive – you can simply toggle between the automatic and manual modes</li> </ul>
Minimization of maintenance times	<ul style="list-style-type: none"> <li>• Diagnostics using plain text display, can be used locally on-site without documentation</li> <li>• The support function is used to determine the drive data for the Power Module, Control Unit and IOP-2 and makes this available as a two-dimensional code (data matrix/QR code)</li> <li>• Easily upgradable to new functional status via USB interface</li> </ul>	<ul style="list-style-type: none"> <li>• Diagnostics with menu prompting with 7-segment display</li> </ul>

# SINAMICS G120X infrastructure converters for HVAC/Water/Wastewater

0.75 kW to 630 kW (1 hp to 700 hp)

Supplementary system components > IOP-2 Intelligent Operator Panel

## Overview

### IOP-2 Intelligent Operator Panel



IOP-2 Intelligent Operator Panel

The Intelligent Operator Panel IOP-2 is a very user-friendly and powerful operator panel for the SINAMICS G120, SINAMICS G120C, SINAMICS G120P, SINAMICS G120X, SINAMICS G120D and SIMATIC ET 200pro FC-2.

The IOP-2 supports both newcomers and drive experts. Thanks to the membrane keyboard with a central sensor control field, high-contrast color displays, menu-based operation and simple setup processes, which do not require special drive know-how, it is easy to commission drives. The updated IOP-2 (from V2.3) offers a new concept, which allows faster and easier commissioning of the drive.

The Quick Startup provides with an overview of the basic parameters required to commission and operate the drive in a few minutes.

Advanced Startup supports easier commissioning of more complex applications and provides the parameters on one screen, thus eliminating the need to switch between different areas within the IOP-2.

Advanced Setup provides with a list of categories that needs to be checked and that guides the user by highlighting the status icons of categories, which have been altered by the user. Furthermore, a drive can be essentially commissioned without having to use a printed parameter list – as the parameters are displayed in plain text, and explanatory help texts and the parameter filtering functions are provided.

The status screen allows the graphical visualization of two process values and the numerical visualization of four process values. Process values can also be displayed in technological units.

The IOP-2 supports standard commissioning of identical drives. For this purpose, a parameter list can be copied from a converter into the IOP-2 and downloaded into other drive units of the same type as required.

The IOP-2 can also use a text editor to create a user-defined parameter list and download it directly to the frequency converter using the IOP-2 download process.

The IOP-2 can be installed in control cabinet doors using the optionally available door mounting kit.

### Updating the IOP-2

The IOP-2 can be updated and expanded using the integrated USB interface.

Data to support future drive systems can be transferred from the PC to the IOP-2. Further, the USB interface allows user languages and simple setup processes that will become available in the future to be subsequently downloaded and the firmware to be updated for the IOP-2<sup>1)</sup>.

The IOP-2 is supplied with power via the USB interface during an update.

### IOP-2 Handheld



IOP-2 Handheld

A handheld version of the IOP-2 can be ordered for mobile use. In addition to the IOP-2, it includes a housing with rechargeable batteries, a charging unit, an RS232 connecting cable, and a USB cable. The charging unit is supplied with connector adapters for Europe, the US and UK. When the batteries are fully charged, the operating time is up to 10 hours.

To connect the IOP-2 Handheld to SINAMICS G120D and SIMATIC ET 200pro FC-2, the RS232 connecting cable with optical interface is required in addition.

<sup>1)</sup> Information on updates for the IOP-2 is available at <https://support.industry.siemens.com/cs/document/67273266>



# SINAMICS G120X infrastructure converters for HVAC/Water/Wastewater

0.75 kW to 630 kW (1 hp to 700 hp)

## Supplementary system components > IOP-2 Intelligent Operator Panel

### Selection and ordering data

Description	Article No.
<b>IOP-2 Intelligent Operator Panel</b> For use with SINAMICS G120 SINAMICS G120C SINAMICS G120P SINAMICS G120X SINAMICS G120D SIMATIC ET 200pro FC-2 Operating languages: English, German, French, Italian, Spanish, Portuguese, Dutch, Swedish, Finnish, Russian, Czech, Polish, Turkish, Chinese Simplified	<b>6SL3255-0AA00-4JA2</b>
<b>IOP-2 Handheld</b> For use with SINAMICS G120 SINAMICS G120C SINAMICS G120P SINAMICS G120X SINAMICS G120D SIMATIC ET 200pro FC-2 Included in the scope of delivery: <ul style="list-style-type: none"> <li>• IOP-2</li> <li>• Handheld housing</li> <li>• Rechargeable batteries (4 × AA)</li> <li>• Charging unit (international)</li> <li>• RS232 connecting cable <sup>1)</sup> 3 m (9.84 ft) long, can be used in combination with SINAMICS G120 SINAMICS G120C SINAMICS G120P SINAMICS G120X</li> <li>• USB cable 1 m (3.28 ft) long</li> </ul>	<b>6SL3255-0AA00-4HA1</b>
<b>Accessories</b>	
<b>Door mounting kit</b> For mounting an operator panel in control cabinet doors with sheet steel thicknesses of 1 ... 3 mm (0.04 in ... 0.12 in) Degree of protection IP55 Included in the scope of delivery: <ul style="list-style-type: none"> <li>• Seal</li> <li>• Mounting material</li> <li>• Connecting cable 5 m (16.4 ft) long, also supplies voltage to the IOP-2 directly via the converter</li> </ul>	<b>6SL3256-0AP00-0JA0</b>
<b>RS232 connecting cable</b> 2.5 m (8.20 ft) long, with optical interface for connecting the IOP-2 Handheld to SINAMICS G120D SIMATIC ET 200pro FC-2	<b>3RK1922-2BP00</b>

### Benefits

- New device design
  - Intuitive user interface – membrane keyboard with central sensor control field
  - High-contrast color display with a range of display options
  - IOP-2 device design open for future functional expansions (e.g. device functions, commissioning setups, languages)
  - Easily upgradable to new functional status via USB interface
- Commissioning
  - Simple commissioning via Quick Startup and Advanced Startup
  - Quick Startup allows easy and fast access to all basic parameters required for the commissioning of simple applications
  - Advanced Startup provides the parameters necessary for the commissioning of more complex applications and eliminates the need to switch between different areas of the IOP-2
  - I/O Setup supports quick and easy configuration of the digital and analog inputs and outputs
  - Fieldbus Setup allows easy configuration of the Ethernet/IP and PROFINET interface protocols
  - Fast standard commissioning of converters thanks to the cloning function
  - For quicker access, the parameter data set names can be directly entered respectively changed on the IOP-2 using the virtual keyboard. Extended help functions support the user during commissioning.
  - Simple local commissioning on-site using the handheld version
- Operator control and monitoring
  - Simple, individual local drive control (start/stop, setpoint value specification, change in direction of rotation)
  - Application-specific scenarios such as operator concepts with additional external operating elements can be implemented easily
  - Simple cloning of specific settings of the IOP-2 user interface, such as status screen, language settings, lighting duration, date/time settings, parameter backup mode and "My Parameters" – settings made once can such be easily transferred to many further IOP-2 Intelligent Operator Panels
  - Easy creation of a user-defined parameter list and direct download to the frequency converter using the IOP-2 download process
- Diagnostics
  - Rapid diagnostics thanks to on-site plain text display
  - Integrated plain text help function for local display and resolution of fault messages
- Support function
  - Used to determine the drive data for the Power Module, Control Unit and IOP-2 (article number, serial number, firmware version, error statuses) and makes this available as a two-dimensional code (data matrix/QR code)
  - Allows easy contact with Customer Support via a data matrix/QR code generated on the IOP-2
  - Quick access via mobile devices (e.g. smartphones, tablets) to product information, documentation, FAQs, contact persons via a two-dimensional code generated on the IOP-2 (data matrix/QR code)
  - Scanning and evaluating of the two-dimensional data matrix code using the Industry Online Support app (<https://support.industry.siemens.com/cs/www/en/sc/2067>), see also: <https://support.industry.siemens.com/cs/document/109748340>

<sup>1)</sup> For use in conjunction with SSINAMICS G120D and SIMATIC ET 200pro FC-2, the RS232 connecting cable with optical interface is required (Article No.: **3RK1922-2BP00**). The cable must be ordered separately.

# SINAMICS G120X infrastructure converters for HVAC/Water/Wastewater

0.75 kW to 630 kW (1 hp to 700 hp)

Supplementary system components > IOP-2 Intelligent Operator Panel

## Integration

### Using the IOP-2 with the converters

	<ul style="list-style-type: none"> <li>SINAMICS G120 with CU230P-2, CU240E-2 or CU250S-2</li> <li>SINAMICS G120C</li> <li>SINAMICS G120P with CU230P-2</li> <li>SINAMICS G120X</li> </ul>	<ul style="list-style-type: none"> <li>SINAMICS G120D</li> <li>SIMATIC ET 200pro FC-2</li> </ul>
<b>Plugging the IOP-2 onto the converter</b> (Voltage supply via converter)	✓	—
<b>Door mounting of the IOP-2 with the door mounting kit</b> (Voltage supply via converter. For this purpose, the IOP-2 must be connected up by means of the connecting cable supplied with the door mounting kit.)	✓	—
<b>Mobile use of the IOP-2 Handheld</b> (supplied from rechargeable batteries)	✓	✓ (RS232 connecting cable with optical interface required, article number 3RK1922-2BP00)

### Door mounting

Using the optionally available door mounting kit, an operator panel can be simply mounted in a control cabinet door with just a few manual operations. In the case of door mounting, the IOP-2 Operator Panel achieves degree of protection IP55/UL Type 12 enclosure.

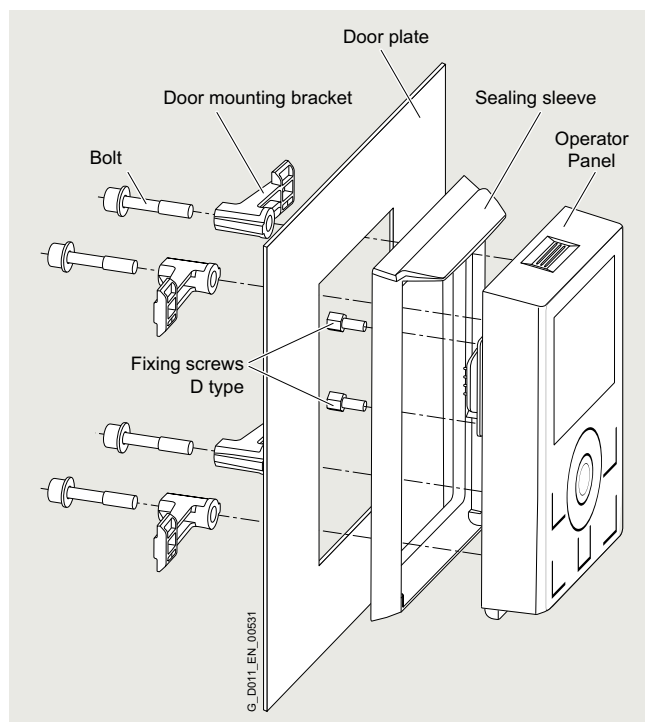

Door mounting kit with plugged-on IOP-2

## Technical specifications

	IOP-2 6SL3255-0AA00-4JA2	IOP-2 Handheld 6SL3255-0AA00-4HA1
<b>Display</b>	High-contrast color display, a variety of display options	
• Resolution	320 × 240 pixels	
<b>Operator panel</b>	Membrane keyboard with central sensor control field	
<b>Operating languages</b>	English, German, French, Italian, Spanish, Portuguese, Dutch, Swedish, Finnish, Russian, Czech, Polish, Turkish, Chinese Simplified	
<b>Ambient temperature</b>	<ul style="list-style-type: none"> <li>During transport and storage: -40 ... +70 °C (-40 ... +158 °F)</li> <li>During operation: For direct mounting on the converter: 0 ... 50 °C (32 ... 122 °F); For installation with door mounting kit: 0 ... 55 °C (32 ... 131 °F)</li> </ul>	
<b>Humidity</b>	Relative humidity < 95 %, non-condensing	
<b>Degree of protection</b>	For direct mounting on the converter: IP20 For installation with door mounting kit: IP55, UL Type 12 enclosure	IP20
<b>Dimensions (H × W × D)</b>	106.86 × 70 × 19.65 mm (4.21 × 2.76 × 0.77 in)	195.04 × 70 × 37.58 mm (7.68 × 2.76 × 1.48 in)
<b>Weight, approx.</b>	0.134 kg (0.3 lb)	0.724 kg (1.6 lb)
<b>Compliance with standards</b>	CE, UKCA, RCM, cULus, EAC, KC-REM-S49-SINAMICS	
<b>Environmental class in operation</b>	<ul style="list-style-type: none"> <li>Harmful chemical substances: Class 3C3 acc. to IEC 60721-3-3: 2002</li> </ul>	

## SINAMICS G120X infrastructure converters for HVAC/Water/Wastewater

0.75 kW to 630 kW (1 hp to 700 hp)

### Supplementary system components > BOP-2 Basic Operator Panel

#### Overview



BOP-2 Basic Operator Panel

The BOP-2 Basic Operator Panel can be used to commission drives, monitor drives in operation and input individual parameter settings.

Commissioning of standard drives is easy with the menu-prompted dialog on a 2-line display. Simultaneous display of the parameter and parameter value, as well as parameter filtering, means that basic commissioning of a drive can be performed easily and, in most cases, without a printed parameter list.

The drives are easily controlled manually using directly assigned navigation buttons. The BOP-2 has a dedicated switchover button to switch from automatic to manual mode.

Diagnostics can easily be performed on the connected converter by following the menus.

Up to two process values can be numerically visualized simultaneously.

BOP-2 supports standard commissioning of identical drives. For this purpose, a parameter list can be copied from a converter into the BOP-2 and when required, downloaded into other drive units of the same type.

The operating temperature of the BOP-2 is 0 °C ... 50 °C (32 °F ... 122 °F).

The environmental class/harmful chemical substances of BOP-2 is class 3C3 acc. to IEC 60721-3-3: 2002.

#### Selection and ordering data

Description	Article No.
<b>BOP-2 Basic Operator Panel</b>	<b>6SL3255-0AA00-4CA1</b>
<b>Accessories</b>	
<b>Door mounting kit</b>	<b>6SL3256-0AP00-0JA0</b>
For mounting an operator panel in control cabinet doors with sheet steel thicknesses of 1 ... 3 mm (0.04 ... 0.12 in) Degree of protection IP55	
Included in the scope of delivery:	
<ul style="list-style-type: none"> <li>• Seal</li> <li>• Mounting material</li> <li>• Connecting cable 5 m/16.4 ft long, also supplies voltage to the operator panel directly via the converter</li> </ul>	

#### Benefits

- Shorten commissioning times – Easy commissioning of standard drives using basic commissioning wizards (setup)
- Minimize standstill times – Fast detection and rectification of faults (Diagnostics)
- Greater transparency in the process – The status display of the BOP-2 makes process variable monitoring easy (Monitoring)
- Direct mounting on the converter
- User-friendly user interface:
  - Easy navigation using clear menu structure and clearly assigned control keys
  - Two-line display

# SINAMICS G120X infrastructure converters for HVAC/Water/Wastewater

0.75 kW to 630 kW (1 hp to 700 hp)

## Supplementary system components > Memory cards

### Overview



SINAMICS SD memory card

The parameter settings for a converter can be stored on the SINAMICS SD memory card. When service is required, e.g. after the converter has been replaced and the data have been downloaded from the memory card, the drive system is immediately ready for use again.

- Parameter settings can be written from the memory card to the converter or saved from the converter to the memory card.
- Up to 100 parameter sets can be stored.
- The memory card supports standard commissioning without the use of an operator panel such as the IOP-2 or BOP-2.
- If firmware is stored on the memory card, the firmware can be upgraded/downgraded during power-up.

#### Note:

The memory card is not required for operation and does not have to remain inserted.

### Selection and ordering data

Description	Article No.
<b>SINAMICS SD card</b> 512 MB, empty	<b>6SL3054-4AG00-2AA0</b>

## SINAMICS G120X infrastructure converters for HVAC/Water/Wastewater

0.75 kW to 630 kW (1 hp to 700 hp)

Supplementary system components > SINAMICS G120 Smart Access

### Overview



SINAMICS G120 Smart Access

It is also easy and convenient to commission and operate the SINAMICS G115D, SINAMICS G120, SINAMICS G120C and SINAMICS G120X converters of firmware V4.7 SP6 and higher using the web server module SINAMICS G120 Smart Access and a connected smartphone, tablet or laptop.

### Benefits

- Wireless commissioning, operation and diagnostics via mobile device or laptop thanks to the optional SINAMICS G120 Smart Access
- Intuitive user interface and commissioning wizard
- Free choice of terminal devices as the web server works with all common web browsers, such as iOS, Android, Microsoft Windows, Linux and Mac OS

### Function

- Commissioning using commissioning wizard
- Setting and saving parameters
- Testing motor in JOG mode
- Monitoring of converter data
- Quick diagnostics
- Saving the settings and restoring to factory settings

### Selection and ordering data

Description	Article No.
<b>SINAMICS G120 Smart Access</b> For wireless commissioning, operation and diagnostics of the following converters using a smartphone, tablet or laptop <ul style="list-style-type: none"> <li>• SINAMICS G115D together with the interface kit for SINAMICS G120 Smart Access</li> <li>• SINAMICS G120C</li> <li>• SINAMICS G120 together with the CU230P-2 and CU240E-2 Control Units (without fail-safe versions)</li> <li>• SINAMICS G120P together with the CU230P-2 Control Unit</li> <li>• SINAMICS G120X</li> </ul>	<b>6SL3255-0AA00-5AA0</b>

### Technical specifications

	<b>SINAMICS G120 Smart Access</b> 6SL3255-0AA00-5AA0
<b>Operating system</b>	iOS, Android, Microsoft Windows, Linux, Mac OS
<b>Languages</b>	Support of six languages: English, French, German, Italian, Spanish, Chinese
<b>Ambient temperature</b>	
• During storage and transport	-40 ... +70 °C (-40 ... +158 °F)
• During operation	0 ... 50 °C (32 ... 122 °F), if the Smart Access is plugged directly into the converter
<b>Humidity</b>	< 95 %, non-condensing
<b>Degree of protection</b>	Depending on the degree of protection of the converter, max. IP55/UL Type 12 enclosure
<b>Dimensions</b>	
• Width	70 mm (2.76 in)
• Height	108.9 mm (4.29 in)
• Depth	17.3 mm (0.68 in)
<b>Weight, approx.</b>	0.08 kg (0.18 lb)
<b>Compliance with standards</b>	CE, UKCA, FCC, SRRC, WPC, ANATEL, BTK

### Integration



SINAMICS G120X frame size FSD with plugged-on SINAMICS G120 Smart Access

The optional SINAMICS G120 Smart Access is simply plugged onto the converter and is available for the following converters of firmware V4.7 SP6 and higher.

- SINAMICS G115D together with the interface kit for SINAMICS G120 Smart Access
- SINAMICS G120C
- SINAMICS G120 together with the CU230P-2 and CU240E-2 Control Units (without fail-safe versions)
- SINAMICS G120P together with the CU230P-2 Control Unit
- SINAMICS G120X

# SINAMICS G120X infrastructure converters for HVAC/Water/Wastewater

0.75 kW to 630 kW (1 hp to 700 hp)

## Supplementary system components > SINAMICS G120X I/O Extension Module

### Overview



SINAMICS G120X I/O Extension Module

The SINAMICS G120X I/O Extension Module increases the number of I/O terminals of the converter and therefore allows for additional converter control functionalities. It also allows for the connection to an operator panel or the SINAMICS G120 Smart Access.

The optional SINAMICS G120X I/O Extension Module has 2 DI, 2 AO, 4 DO (relay), and up to 2 Pt1000/Ni1000 temperature sensors can be directly connected.

#### Notes:

The SINAMICS G120X I/O Extension Module is only supported for SINAMICS G120X converters with hardware versions  $\geq$  02 02 (FSA to FSG) / 02 (FSH and FSJ) and firmware  $\geq$  V1.01. The hardware version can be found on the rating plate of the converter.

### Selection and ordering data

Description	Article No.
<b>SINAMICS G120X I/O Extension Module</b> for the direct connection of Pt1000/Ni1000 temperature sensors	<b>6SL3255-0BE00-0AA0</b>

### More information

Further information and documentation is available on the internet at:  
[www.siemens.com/sinamics-g120x/documentation](http://www.siemens.com/sinamics-g120x/documentation)

### Technical specifications

Article No.	6SL3255-0BE00-0AA0
<b>Analog inputs</b>	
Number of analog inputs	2
Design of the sensor to detect the ambient temperature connectable	2 analog inputs for connecting temperature sensors Pt1000/Ni1000. One of them can be used as an analog input.
Connectable conductor cross-section at the analog input	0.5 ... 1.5 mm <sup>2</sup>
AWG number as coded connectable conductor cross-section at the analog input	21 ... 16
Input current	0 ... 20 mA
<b>Analog outputs</b>	
Number of analog outputs	2
Analog outputs Type	Non-isolated output
Connectable conductor cross-section at the analog output	0.5 ... 1.5 mm <sup>2</sup>
AWG number as coded connectable conductor cross-section at the analog output	21 ... 16
Output voltage at analog output	0 ... 10 V
Output current at analog output	0 ... 20 mA
<b>Digital inputs</b>	
Number of digital inputs	2
Connectable conductor cross-section at the digital inputs	0.5 ... 1.5 mm <sup>2</sup>
AWG number as coded connectable conductor cross-section at the digital inputs	21 ... 16
Digital inputs Input voltage for signal "0" → "1"	11 V
Digital inputs Input voltage for signal "1" → "0"	5 V
Input voltage at digital input maximum	30 V
<b>Digital outputs</b>	
Number of digital outputs	4
Connectable conductor cross-section at the digital outputs maximum	1.5 mm <sup>2</sup>
AWG number as coded connectable conductor cross section at the digital outputs maximum	16
Output current at digital output	2 A
<b>Mechanical data</b>	
Width	71 mm
Depth	27 mm
Height	117 mm



## SINAMICS G120X infrastructure converters for HVAC/Water/Wastewater

0.75 kW to 630 kW (1 hp to 700 hp)

### Supplementary system components > Push-through mounting frames for frame sizes FSA to FSG

#### Overview



SINAMICS G120X frame size FSC with IOP-2 Intelligent Operator Panel and push-through mounting frame

The optional push-through mounting frame is used to install a SINAMICS G120X converter, frame sizes FSA to FSG, in a control cabinet with the heat sink outside the control cabinet. The converter achieves degree of protection IP20/UL Open Type with push-through installation.

For push-through installation of frame sizes FSD to FSG, installation handles are available for insertion without the need for a lifting device.

#### Selection and ordering data

Description	Article No.
<b>Push-through mounting frames</b> for SINAMICS G120X	
• Frame size FSA	<b>6SL3261-6GA00-0BA0</b>
• Frame size FSB	<b>6SL3261-6GB00-0BA0</b>
• Frame size FSC	<b>6SL3261-6GC00-0BA0</b>
• Frame size FSD	<b>6SL3261-6GD00-0BA0</b>
• Frame size FSE	<b>6SL3261-6GE00-0BA0</b>
• Frame size FSF	<b>6SL3261-6GF00-0BA0</b>
• Frame size FSG	<b>6SL3261-6GG00-0BA0</b>
<b>Accessories</b>	
<b>Installation handles</b> for SINAMICS G120X frame sizes FSD to FSG	<b>6SL3200-0SM22-0AA0</b>

### Supplementary system components > IP21 top covers for frame sizes FSA to FSG

#### Overview



SINAMICS G120X frame size FSC with IOP-2 Intelligent Operator Panel and IP21 top cover

Using the optional IP21 top cover, SINAMICS G120X converters in frame sizes FSA to FSG achieve degree of protection 21. With wall mounting, the IP21 top cover has to be installed above the converter.

#### Dimensional drawings

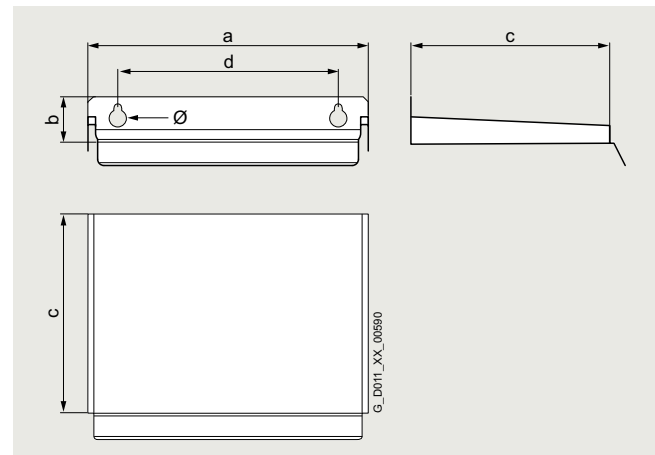

Frame size	Dimensions in mm (inches)			Drilling dimensions in mm (inches)		Cooling clearance between converter and IP21 top cover
	a (width)	b (height)	c (depth)	d	∅	
FSA	120 (4.72)	25 (0.98)	306 (12.05)	80 (3.15)	4.5 (0.18)	100 (3.94)
FSB	160 (6.3)	25 (0.98)	306 (12.05)	118 (4.65)	5.5 (0.22)	100 (3.94)
FSC	260 (10.24)	29 (1.14)	323 (12.72)	170 (6.69)	6 (0.24)	100 (3.94)
FSD	260 (10.24)	29 (1.14)	323 (12.72)	170 (6.69)	6 (0.24)	300 (11.81)
FSE	335 (13.19)	29 (1.14)	323 (12.72)	230 (9.06)	6 (0.24)	300 (11.81)
FSF, FSG	365 (14.37)	29 (1.14)	443 (17.44)	270 (10.63)	6 (0.24)	300 (11.81)

#### Selection and ordering data

Description	Article No.
<b>IP21 top covers</b> for SINAMICS G120X	
• Frame size FSA	<b>6SL3266-1PA00-0BA0</b>
• Frame size FSB	<b>6SL3266-1PB00-0BA0</b>
• Frame sizes FSC and FSD	<b>6SL3266-1PD00-0BA0</b>
• Frame size FSE	<b>6SL3266-1PE00-0BA0</b>
• Frame sizes FSF and FSG	<b>6SL3266-1PF00-0BA0</b>

# SINAMICS G120X infrastructure converters for HVAC/Water/Wastewater

0.75 kW to 630 kW (1 hp to 700 hp)

Supplementary system components > Wiring adapter for frame size FSG

## Overview

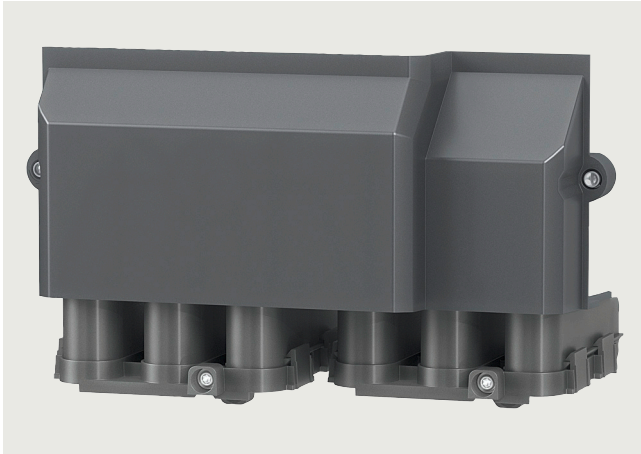

Wiring adapter for frame size FSG

The wiring adapter enables optimal and space-saving wiring of frame size FSG for SINAMICS G120 PM240-2 Power Modules and SINAMICS G120X.

Smaller bending radii help where mounting space is constricted: Up to four smaller cables (with a cross section of 120 mm<sup>2</sup> each) can be routed with the adapter for connection to the line supply and to the motor. All cables can be connected on the underside of the adapter, which allows for easy and space-saving wiring.

The scope of delivery of the wiring adapter includes contacts, nuts, a cover and various small components.

## Integration



SINAMICS G120 frame size FSG with wiring adapter (and cable outlet)

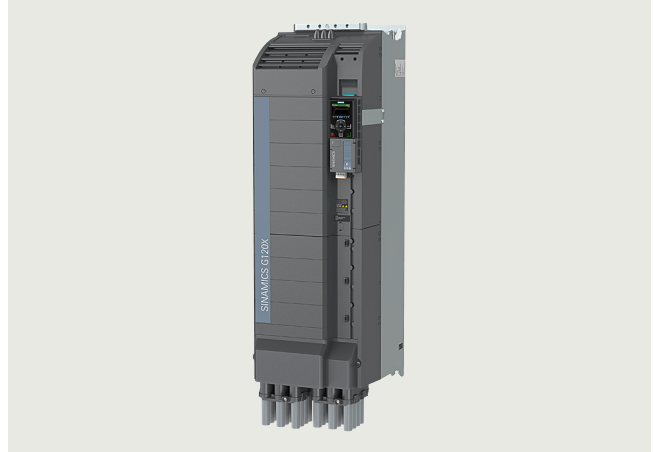

SINAMICS G120X frame size FSG with wiring adapter (and cable outlet)

Further documentation on SINAMICS G120 is available free on the internet at:

[www.siemens.com/sinamics-g120/documentation](http://www.siemens.com/sinamics-g120/documentation)

Further documentation on SINAMICS G120X is available free on the internet at:

[www.siemens.com/sinamics-g120x/documentation](http://www.siemens.com/sinamics-g120x/documentation)

## Selection and ordering data

Description	Article No.
<b>Wiring adapter for frame size FSG</b> for optimal and space-saving wiring of SINAMICS G120 PM240-2 Power Modules and SINAMICS G120X	<b>6SL3266-2HG00-0BA0</b>

## SINAMICS G120X infrastructure converters for HVAC/Water/Wastewater

0.75 kW to 630 kW (1 hp to 700 hp)

### Supplementary system components > Installation kit for line-side cable connection, left, for frame size FSH

#### Overview

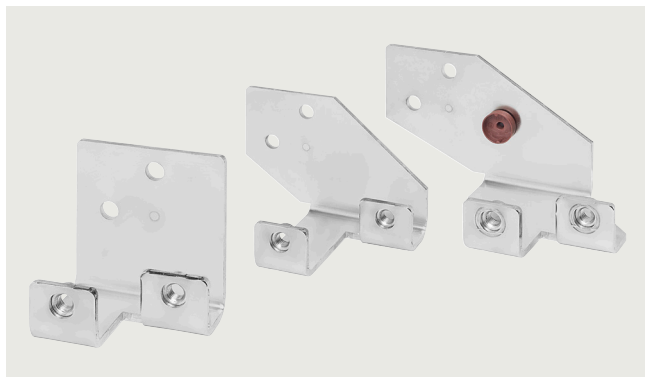

Installation kit for line-side cable connection, left, for SINAMICS G120X, frame size FSH

This installation kit allows supply cables of the SINAMICS G120X converter, frame size FSH, to be connected alternatively on the left-hand side of the converter. The converter can thus be installed higher in the control cabinet, allowing more efficient use of the available cabinet space. In many cases, use of this installation kit also helps in the implementation of effective cabinet cooling.

#### Selection and ordering data

Description	Article No.
<b>Installation kit for line-side cable connection, left</b> for SINAMICS G120X frame size FSH	<b>6SL3366-1LH00-0PA0</b>

### Spare parts > FPI board for frame sizes FSH and FSJ

#### Overview

The FPI board (freely-programmable interface board) is available as a spare part for the SINAMICS G120X converter, frame sizes FSH and FSJ. This is an interface board between Control Unit and Power Module with additional customer terminals (X9, X41).

#### Selection and ordering data

Description	Article No.
<b>FPI board</b> for SINAMICS G120X frame sizes FSH and FSJ	<b>6SL3200-OSP05-0AA0</b>

### Spare parts > PSB board for frame sizes FSH and FSJ

#### Overview

The PSB board (power supply board) is available as a spare part for the SINAMICS G120X converter, frame sizes FSH and FSJ. This is an internal power supply with  $\pm 24$  V for the electronics and 56 V for a power unit fan.

#### Selection and ordering data

Description	Article No.
<b>PSB board</b> for SINAMICS G120X frame sizes FSH and FSJ	<b>6SL3200-OSP06-0AA0</b>

### Spare parts > Current transformers for frame sizes FSH and FSJ

#### Overview

Current transformers are available as spare parts for the SINAMICS G120X converter, frame sizes FSH and FSJ. These are 2000 A or 1000 A current transformers for measuring the motor current at the device output. The current transformers are used for motor control and converter protection.

#### Selection and ordering data

Description	Article No.
<b>Current transformers</b> for SINAMICS G120X	
• 2000 A for frame size FSJ	<b>6SL3200-0SE01-0AA0</b>
• 1000 A for frame sizes FSH and FSJ	<b>6SL3200-0SE02-0AA0</b>

## SINAMICS G120X infrastructure converters for HVAC/Water/Wastewater

0.75 kW to 630 kW (1 hp to 700 hp)

### Spare parts > Spare parts kit for Control Unit

#### Overview

The spare parts kit contains small parts for the SINAMICS G120X Control Unit:

Included in the scope of delivery:

- 1× STO connecting plug for frame sizes FSA to FSC
- 3× replacement doors for the Control Unit
- 4× I/O terminals
- 1× screw for RS485 terminal
- 1× blanking cover
- Label set

#### Selection and ordering data

Description	Article No.
<b>Spare parts kit for Control Unit</b> for SINAMICS G120X	<b>6SL3200-0SK10-0AA0</b>

### Spare parts > Shield connection kit for Control Unit

#### Overview

A shield connection kit for the Control Unit is supplied with the SINAMICS G120X converters, frame sizes FSD to FSG. It is advisable to install the supplied shield connection kit for EMC-compliant configuration of the converter. This shield connection kit can be ordered as a spare part.

The shield connection kit offers optimum shield connection and strain relief for all signal and communication cables.

The kit contains the following:

- a matching shield connection plate
- all of the necessary connecting and retaining elements for mounting

#### Selection and ordering data

Description	Article No.
<b>Shield connection kit for Control Unit</b> for SINAMICS G120X frame sizes FSD to FSG	<b>6SL3264-1EA00-0YA0</b>

### Spare parts > Shield connection kits for Power Module

#### Overview

A shield connection kit is supplied with the SINAMICS G120X converters, frame sizes FSA to FSG. It is advisable to install the supplied shield connection kit for EMC-compliant configuration of the converter. These shield connection kits can be ordered as spare parts.

Please observe the notes included in the operating instructions for the SINAMICS G120X converters, frame sizes FSH and FSJ.

[www.siemens.com/sinamics-g120x/documentation](http://www.siemens.com/sinamics-g120x/documentation)

#### Selection and ordering data

Description	Article No.
<b>Shield connection kits for Power Module</b> for SINAMICS G120X	
• Frame size FSA	<b>6SL3262-1AA01-0DA0</b>
• Frame size FSB	<b>6SL3262-1AB01-0DA0</b>
• Frame size FSC	<b>6SL3262-1AC01-0DA0</b>
• Frame size FSD	<b>6SL3262-1AD01-0DA0</b>
• Frame size FSE	<b>6SL3262-1AE01-0DA0</b>
• Frame size FSF	<b>6SL3262-1AF01-0DA0</b>
• Frame size FSG	<b>6SL3262-1AG01-0DA0</b>

### Spare parts > Small parts assembly set for frame sizes FSD to FSG

#### Overview

A **small parts assembly set** can be ordered for SINAMICS G120 Power Modules PM240-2, SINAMICS G120C and SINAMICS G120X, degree of protection IP20. It contains the following parts:

- Cable entries for frame sizes FSD to FSG
- 2 × 2 pin STO mating connector
- 1 set of warning labels in 30 languages

#### Selection and ordering data

Description	Article No.
<b>Small parts assembly set</b> for SINAMICS G120 Power Modules PM240-2, SINAMICS G120C and SINAMICS G120X degree of protection IP20, frame sizes FSD to FSG	<b>6SL3200-0SK08-0AA0</b>

## SINAMICS G120X infrastructure converters for HVAC/Water/Wastewater

0.75 kW to 630 kW (1 hp to 700 hp)

### Spare parts > Terminal cover kits for frame sizes FSD to FSG

#### Overview

The terminal cover kit includes a replacement cover for the connecting terminals.

Terminal cover kits, which are suitable for the following converters in frame sizes FSD to FSG, are available:

- SINAMICS G120 PM240-2 Power Modules
- SINAMICS G120 PM250 Power Modules
- SINAMICS G120C
- SINAMICS G120X

#### Selection and ordering data

Description	Article No.
<b>Terminal cover kits for SINAMICS G120 PM240-2 Power Modules</b> <ul style="list-style-type: none"> <li>• for frame size FSD</li> <li>• for frame size FSE</li> <li>• for frame size FSF</li> <li>• for frame size FSG</li> </ul>	6SL3200-0SM13-0AA0 6SL3200-0SM14-0AA0 6SL3200-0SM15-0AA0 6SL3200-0SM16-0AA0
<b>Terminal cover kits for SINAMICS G120 PM250 Power Modules</b> <ul style="list-style-type: none"> <li>• for frame sizes FSD and FSE</li> <li>• for frame size FSF</li> </ul>	6SL3200-0SM11-0AA0 6SL3200-0SM12-0AA0
<b>Terminal cover kits for SINAMICS G120C</b> <ul style="list-style-type: none"> <li>• for frame size FSD</li> <li>• for frame size FSE</li> <li>• for frame size FSF</li> </ul>	6SL3200-0SM13-0AA0 6SL3200-0SM14-0AA0 6SL3200-0SM15-0AA0
<b>Terminal cover kits for SINAMICS G120X</b> <ul style="list-style-type: none"> <li>• for frame size FSD</li> <li>• for frame size FSE</li> <li>• for frame size FSF</li> <li>• for frame size FSG</li> </ul>	6SL3200-0SM13-0AA0 6SL3200-0SM14-0AA0 6SL3200-0SM15-0AA0 6SL3200-0SM16-0AA0

### Spare parts > Fan units

#### Overview

The fans of the SINAMICS G120X converters are designed for extra long service life. For special requirements, replacement fans are available that can be exchanged quickly and easily.

#### Selection and ordering data

Description	Article No.
<b>External fan units for SINAMICS G120X</b> <ul style="list-style-type: none"> <li>• Frame size FSA</li> <li>• Frame size FSB</li> <li>• Frame size FSC</li> <li>• Frame size FSD</li> <li>• Frame size FSE</li> <li>• Frame size FSF</li> <li>• Frame size FSG</li> <li>• Frame sizes FSH and FSJ</li> </ul>	6SL3200-0SF52-0AA0 6SL3200-0SF53-0AA0 6SL3200-0SF54-0AA0 6SL3200-0SF15-0AA0 6SL3200-0SF16-0AA0 6SL3200-0SF17-0AA0 6SL3200-0SF18-0AA0 6SL3300-0SF01-0AA0
<b>Internal fan unit for SINAMICS G120X</b> <ul style="list-style-type: none"> <li>• Frame sizes FSH and FSJ</li> </ul>	6SL3200-0SF50-0AA0

### Spare parts > Control Units

#### Overview

Control units are available as spare parts for the SINAMICS G120X converter frame sizes FSD to FSJ.

#### Selection and ordering data

Description	Article No.
<b>Control Units for SINAMICS G120X frame sizes FSD to FSJ</b> <ul style="list-style-type: none"> <li>• USS, Modbus RTU, BACnet MS/TP</li> <li>• PROFINET, EtherNet/IP</li> <li>• PROFIBUS DP</li> </ul>	6SL3200-0SC10-0BA0 6SL3200-0SC10-0FA0 6SL3200-0SC10-0PA0



### SINAMICS Selector App

#### Mobile selection guide for frequency converters



Siemens has developed the SINAMICS Selector app as a practical tool for finding article numbers for your SINAMICS converter in the power range from 0.1 kW to 630 kW quickly and easily. Whether for SINAMICS V20, SINAMICS V90, SINAMICS G120C, SINAMICS G120P, SINAMICS G120X, SINAMICS G120, SINAMICS G220, SINAMICS S200 or SINAMICS S210: The app will provide you with the correct article numbers conveniently.

How does it work? Simply select your application, the frequency converter you require, the rated power and device options as well as the necessary accessories. Then you can save your selection and send it by email. The preselection serves as the basis for an order specification with the dealer/Siemens.

You will find free downloads for Android and iOS here:

[www.siemens.com/sinamics-selector](http://www.siemens.com/sinamics-selector)

### SINAMICS ASSISTANT app

The error code function of the SINAMICS ASSISTANT app helps you to identify and rectify errors. Just enter the error code of your frequency converter and the app shows you what sort of error it is and how you can rectify it.

This app also recalculates for you the frequency (Hz) of a frequency converter into the speed to be set on the motor (r/min) or vice versa.

In addition this app offers you a support page on which you can get in touch straight away with the right contact person in your region if you have any questions. Furthermore, video information is available to you free of charge, e.g. on installation and commissioning of the SINAMICS G120 frequency converter. You will find the free downloads for Android and for iOS at the following link: [www.siemens.com/sinamics-assistant](http://www.siemens.com/sinamics-assistant)

3/2	<b>SINAMICS DriveSim Designer</b>
3/4	<b>Siemens Product Configurator</b>
3/5	<b>SIMARIS planning tools for systems with SINAMICS drives</b>
3/7	<b>SinaSave energy efficiency tool</b>
3/8	<b>SIZER for Siemens Drives engineering tool (integrated into TIA Selection Tool)</b>
3/9	<b>SINAMICS web server for SINAMICS G120X via SINAMICS G120 Smart Access</b>

### Cybersecurity information

Siemens provides products and solutions with industrial cybersecurity functions that support the secure operation of plants, systems, machines and networks.

In order to protect plants, systems, machines and networks against cyber threats, it is necessary to implement – and continuously maintain – a holistic, state-of-the-art industrial cybersecurity concept. Siemens' products and solutions constitute one element of such a concept.

Customers are responsible for preventing unauthorized access to their plants, systems, machines and networks. Such systems, machines and components should only be connected to an enterprise network or the internet if and to the extent such a connection is necessary and only when appropriate security measures (e.g. firewalls and/or network segmentation) are in place.

For additional information on industrial cybersecurity measures that may be implemented, please visit

[www.siemens.com/cybersecurity-industry](http://www.siemens.com/cybersecurity-industry)

Siemens' products and solutions undergo continuous development to make them more secure. Siemens strongly recommends that product updates are applied as soon as they are available and that the latest product versions are used. Use of product versions that are no longer supported, and failure to apply the latest updates may increase customer's exposure to cyber threats.

To stay informed about product updates, subscribe to the Siemens Industrial Cybersecurity RSS Feed under [www.siemens.com/cert](http://www.siemens.com/cert)



## Engineering tools

### DriveSim Designer

#### Overview

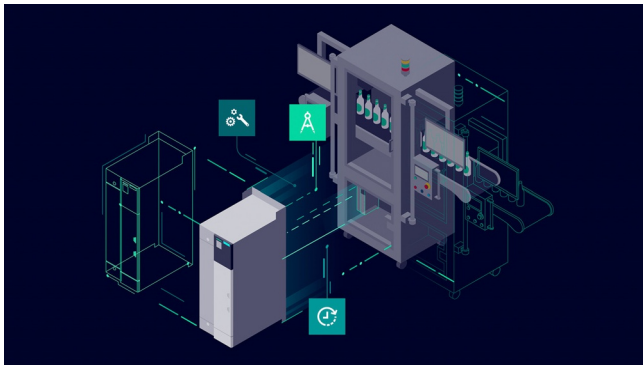

DriveSim Designer provides easy-to-use models for PROFIdrive-enabled SINAMICS converters, so you can create a digital twin of your drive.

The models are validated and tested against real SINAMICS converters and are available in the form of a standardized FMU (Functional Mockup Unit). Therefore, they are compatible with various standard time-based simulation programs such as SIMIT, Simcenter Amesim, ANSYS Twin Builder, MATLAB Simulink or Hopsan.

DriveSim Designer is another element in your engineering toolbox. Together with other virtual Siemens solutions, e.g. SIMATIC S7-PLCSIM Advanced or NX Mechatronics Concept Designer, a consistent model-based development process can be implemented.

#### Benefits

- Speed up time-to-market for OEMs
- Test validated SINAMICS models under real conditions already at the design or planning stage and make needed adjustments
- Identify issues and improvement capabilities early in the design stage and reduce testing effort to save time and cost
- Download the free-of-charge basic version with reduced functionality set, DriveSim Basic, to try the suitability of our solution before buying it
- The full version DriveSim Designer offers a wide range of additional functionalities to improve the SINAMICS simulation model, e. g. safety or position telegrams
- Valid for the most used Siemens drives

Advantages of DriveSim Designer compared to SIMIT PROFIdrive blocks:

- Increased level of detail due to speed controller, current setpoint filters and internal load model
- Identical parameter values and meaning as in the real SINAMICS device
- Direct reference to SINAMICS documentation
- Basic Safety functions
- Brake control functions for lifting applications
- Validated against the real SINAMICS drive
- No wiring effort to represent functional configurations
- Significant reduction of SIMIT simulation tags (even more is possible if unused in-/ outputs are deselected within the Component Type Editor (CTE))
- Enables simulation of an (internal) two-mass oscillator as application with realistic SINAMICS parameter settings, besides the known limitations by the minimum sample time in SIMIT
- Compatible with every FMU Co-Simulation 2.0 compatible simulation tool

#### Application

With DriveSim Designer, you can implement three major use cases:

- Providing load characteristics for drive selection and dimensioning
- Virtual commission your PLC already in the design phase
- Test and improve interaction between PLC, drives and application virtually

Use case 1: Dimension and size the correct drive and motor for your application

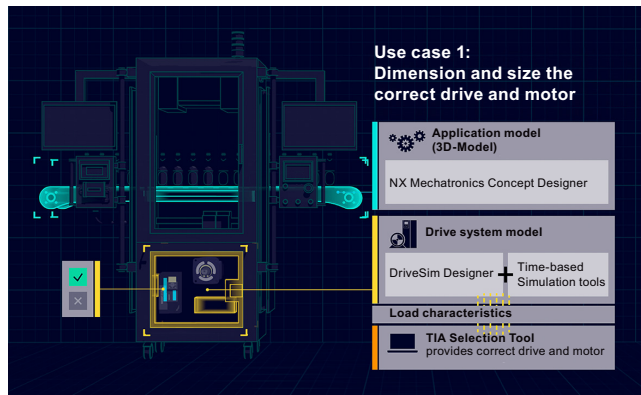

If you are designing a machine, you want to make sure that you select the SINAMICS converter and SIMOTICS motor most suitable for your drive application. As DriveSim Designer is control-unit-agnostic and thus represents a generic drive, you can parametrize it according to the functionality of your application. Running the simulation results in load characteristics, i.e. torque or speed curves over time. You can import these load profiles into TIA Selection Tool to select the suitable Control Unit and dimension the drive to best fit to the demand. So as a result you have well selected SINAMICS converters and SIMOTICS motors with the help of the digital twin.

Use case 2: Virtual commission your drive and PLC early in the design phase

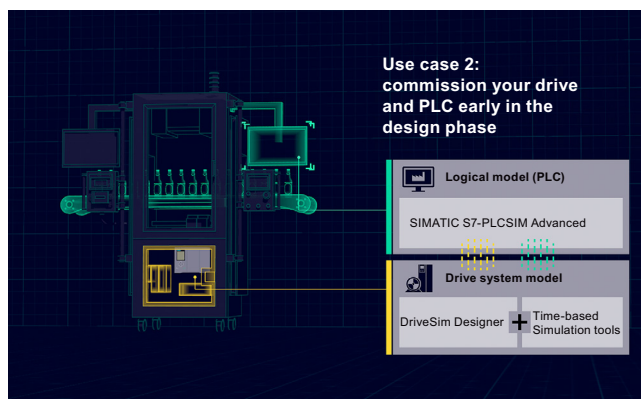

If you are designing a machine, you want to make sure the PLC code works with your SINAMICS drive. After writing the PLC code in TIA Portal, you can connect it via PLCSIM Advanced to any time-based simulation tool (e.g. SIMIT). Integrated into the simulation tool, DriveSim Designer acts as a realistic communication partner for the PLC. Next, you can commission the virtual PLC in TIA Portal as you would do with a real PLC connected to a real drive. Without simulation, you would need to do that on-site. With simulation, you not only save time, but also have the freedom to try out various configurations and optimize your PLC code early in the process.

### Use case 3: Combine the application model and automation model with realistic drive system behavior

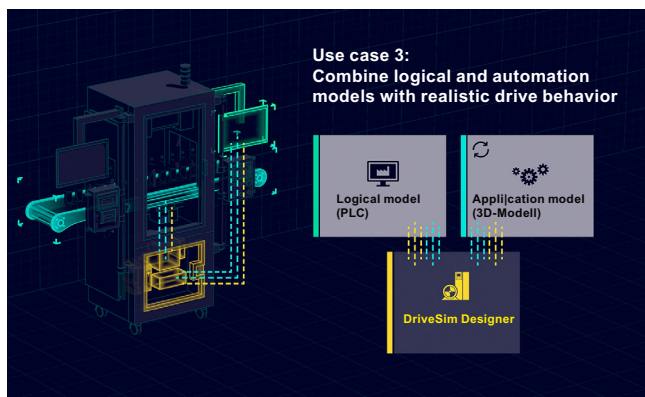

With the third Use case, you can connect a simulation tool such as NX Mechatronic Concept Designer to visualize the mechanical movements of your application. This way, you ensure that the drive behaves according to the desired machine performance. You can test several fault scenarios and optimize the interaction between PLC, application and drive virtually so overall, you can avoid unplanned machine behavior and increase the performance of your setup.

### Integration

DriveSim Designer can be run in tools that support FMU 2.0 Co-Simulation Import (<https://fmi-standard.org/tools/>).

The FMU has been tested in the following simulation environments and is available in the attached application examples.

Tool	Manufacturer	DriveSim*** variant	PLC Sim Advanced interface	Notes
SIMIT	Siemens	***.fmu	Yes	<ul style="list-style-type: none"> <li>Permissible configuration: ExternalLoad = 1 &amp; . Speed-Controller = 0 or ExternalLoad = 0 &amp; . Speed-Controller = 1</li> <li>Simulation with external load can provide wrong results because the minimum possible time step is 1 ms</li> </ul>
Simcenter Amesim	Siemens	***_double.fmu	Yes	
MATLAB Simulink	MathWorks	< 2019a ***_unstruct.fmu ≥ 2019a ***.fmu	Yes	
ANSYS Twin Builder	ANSYS	***.fmu	No	
Hopsan	Linköping University	***_double.fmu	No	<ul style="list-style-type: none"> <li>Open Source</li> <li>Install "win64-with_compiler-installer.exe" package</li> </ul>

### Selection and ordering data

Description	Article No.
DriveSim Designer	9SV1110-3AA00-0AA0

### More information

More information is provided on the internet at:  
[www.siemens.com/drive-virtualization](http://www.siemens.com/drive-virtualization)  
<https://support.industry.siemens.com/cs/document/109812859>

You can find more videos on the topic at:

- [Simulation of drive systems - Quick, Easy and Validated](#)
- [Simulation of drive systems - An introduction to SINAMICS](#)
- [Getting started with DriveSim Designer](#)
- [How to import DriveSim Designer into SIMIT, Matlab Simulink, Amesim and ANSYS TwinBuilder](#)
- [How to connect DriveSim Designer via PLCSim Advance to TIA Portal](#)
- [How to use DriveSim Designer for drive sizing with TIA Selection Tool](#)
- [How to visualize drive system behavior in NX Mechatronics Concept Designer](#)

## Engineering tools

### Siemens Product Configurator

#### Overview

The Siemens Product Configurator helps you to configure the optimum drive technology products for a number of applications. The product portfolio comprises the full drive technology range of gearbox, motor, converter and connection system as well as corresponding controller with suitable software license. The intuitive user interface in conjunction with product-specific preliminary selectors makes it simple, fast and efficient to configure products. The result is a bill of materials with extensive documentation consisting of technical data sheets, motor characteristic curves, 2D dimensional drawings / 3D CAD models, EPLAN macros and much more. You can order the products directly by transferring the bill of materials to the shopping cart of SiePortal.



#### **Siemens Product Configurator at a glance**

- Quick and easy configuration of drive products and associated components – gearboxes, motors, converters, controllers, connection systems
- Extensive documentation for all products and components, such as
  - Data sheets in up to 12 languages
  - Motor characteristic curves
  - 2D dimensional drawings / 3D CAD models in different formats
  - Terminal box drawing and terminal connection diagram
  - Certificates
  - EPLAN macros
- Ability to order products directly through SiePortal

#### Access to the Siemens Product Configurator

The Siemens Product Configurator can be accessed without the need for registration or logging in:  
[www.siemens.com/spc](http://www.siemens.com/spc)

## Overview

### Electrical Planning: Simplified by Electrical Design Software!

Electrical planning of power distribution systems in functional and industrial buildings has never been easy and is now more complex than ever. The electrical calculation software tools SIMARIS design for dimensioning and SIMARIS project for determination of the distribution boards' space requirements support technical planners with the electrical planning process with SINAMICS drives.

#### Supported SINAMICS drives:

- SINAMICS G120, SINAMICS G120D, SINAMICS G120X
- SINAMICS G115D
- SINAMICS G130, SINAMICS G150

## SIMARIS planning tools for systems with SINAMICS drives > SIMARIS design

## Overview

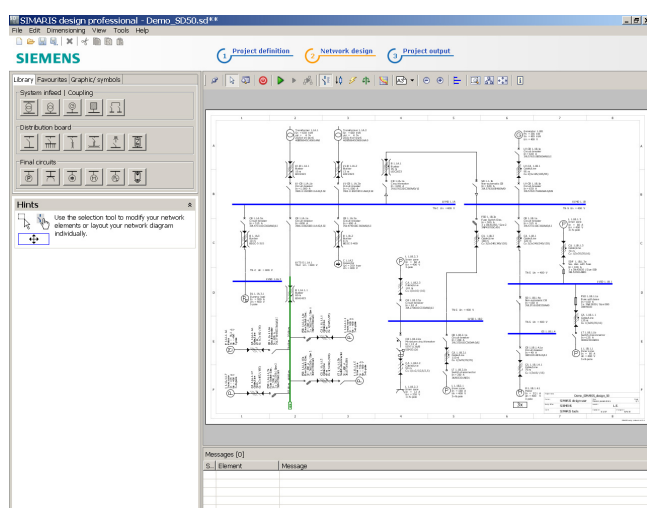

SIMARIS design is a planning tool for quick and effective network calculation and dimensioning of power distribution for non-residential and industrial buildings.

Starting in the planning phase, the entire electrical circuit required for the project can be structured and dimensioned on the basis of real products. For this purpose, the network structure is initially set up based on the stored modules for infeeds, couplings, distributors and branch circuits. It is also possible to reuse stored favorites, such as those processed for previous similar projects. Suitable components and distribution systems are then automatically selected from the product database stored in SIMARIS design based on the selected project-specific parameters and technical data. This precludes the extra costs so often incurred in the implementation phase as a result of systems that have not been correctly coordinated.

Any configuration of electric power distribution is subject to frequent change and adaptation, not only in the planning phase, but also in the implementation phase. SIMARIS design makes it easy to incorporate such changes in the supply concept and to automatically check their reliability in terms of sound engineering practice and the currently applicable standards.

SIMARIS design professional, a program version available for a fee, offers additional useful functions. It can be used to carry out and also document selectivity analyses, essential for safety power supply systems. There is also the option of analyzing and optimizing the energy efficiency of the planned network.

The versatile output variants enable precise documentation of the project structure and of the calculated data suitable for every phase of a project.

There is also the option of exporting the project data. This enables further processing of the planned project in SIMARIS project, and thus also supports and facilitates system planning.

## Benefits

- Reduction in processing overhead for projects
- Dimensioning of electrical networks on the basis of real products according to sound engineering practice and the currently applicable standards (VDE, IEC)
- Automatic selection of the correct components from medium voltage through to interfacing of the load from the stored product database, i.e. no detailed knowledge of products and systems required
- Open definition of the types of mains operation and switching states
- Calculation of the short circuit current, load flow, voltage drop and energy balance
- Incorporation of the required person, short circuit and overload protection
- Option of factoring in any necessary functional endurance
- Display and dimensioning of cable and busbar trunking systems for power conveyance and distribution
- High planning reliability coupled with flexibility in the planning and implementation process
- Tracking changes via change index possible
- Simple adaptation in the case of application changes or expansions
- Option for saving frequently required modules in the favorites library
- Output of the created network diagram, as well as detailed parts lists and data lists
- Incorporation of country-specific product portfolios
- Comprehensive documentation of planning results with simple data transfer (Office, CAD etc.)

## Application

SIMARIS design is a software tool for the network calculation and dimensioning of power distribution for non-residential and industrial buildings. Whether for a shopping center, a hospital or production facilities - with SIMARIS design you can reduce the overhead required for the overall planning of power distribution systems and hence the time spent on the selection and dimensioning of equipment.

## More information

For further information and available downloads, please go to: [www.siemens.com/simarisdg](http://www.siemens.com/simarisdg)

If you have any other questions, please do not hesitate to contact our Customer Support Center:

Phone: +49 70 00 7 46 27 47

Email: [technical-assistance@siemens.com](mailto:technical-assistance@siemens.com)



## Engineering tools

### SIMARIS planning tools for systems with SINAMICS drives > SIMARIS project

#### Overview

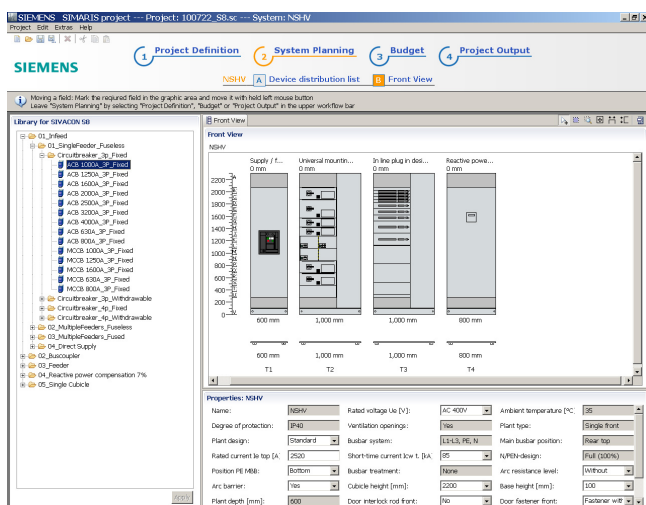

SIMARIS project is a planning tool for fast calculation of space requirements and electrical power distribution system budgets for non-residential and industrial buildings, and for generating specifications automatically.

The following is determined in SIMARIS project based on the pre-defined project structure and the basic technical specifications selected:

- For medium-voltage switchboards: selection of the required system and the required fields, then presentation of a front view with dimensions.
- Following selection of the system for transformers, the required quantity must be selected. Selected transformers are presented as a parts list.
- For low-voltage switchboards and distribution boards: selection of the required protection devices and switching devices per system. The most suitable distribution system is determined automatically based on the list of distribution devices thus created. It is then equipped with the devices and presented graphically in an automatically generated front view that includes dimensions.
- Following selection of the system for busbar trunking systems the length is specified and the additionally required components are selected, e.g. infeeds, junction units and tap-off units. All the resulting components are listed in a parts list.

Detailed information about Siemens devices or their article numbers is not needed because SIMARIS project makes the selection automatically on the basis of the parameters entered. For each item of switchboard or each distribution board, SIMARIS project takes the wiring, control and measurement etc. into account.

A system plan drawn up in SIMARIS design can also be imported into SIMARIS project, which means that selecting devices becomes redundant and SIMARIS project builds up the project structure automatically.

Convenient output versions are available to document the results, including the automatic generation of specifications for the planned systems.

Typical versions of a system planned in SIMARIS project can be saved and repeatedly integrated in new projects from the favorites library. Automatically created systems can also be subsequently optimized or changed. This is particularly relevant if planning becomes more detailed and the budget needs to be re-inforced as a result.

For detailed calculation of costs - on an up-to-date and regional basis - and for more project support, please contact your Siemens representative.

#### Benefits

- Intuitive and easy to operate
- Automatic selection and placement of matching distribution systems
- Fast determination of the space requirements and cost of power distribution plants
- End-to-end planning, from medium-voltage switchgear assemblies, transformers, low-voltage switchgear and busbar trunking systems right through to the distribution boards
- Simple adaptation of project planning with increasing clarification of implementation requirements, but also in the event of application changes or expansions
- Saving planned systems for similar projects individually in the favorites library and importing them from there into new projects
- Option of factoring in functional endurance for busbar systems
- Convenient output versions for documentation, such as graphic views, lists and specifications
- Projects created in SIMARIS design can also be imported

#### Application

SIMARIS project is suitable for the fast determination of the space requirements and cost of electrical power distribution in all industrial and non-residential buildings and for the automatic generation of specifications. From shopping centers to hospitals and production buildings – with SIMARIS project it is possible to reduce the amount of work required for the overall planning of power distribution systems and hence the time spent on selecting and dimensioning the necessary equipment.

#### More information

For further information and available downloads, please go to: [www.siemens.com/simariproject](http://www.siemens.com/simariproject)

If you have any other questions, please do not hesitate to contact our Customer Support Center:

Phone: +49 70 00 7 46 27 47  
Email: [technical-assistance@siemens.com](mailto:technical-assistance@siemens.com)

## Overview

SinaSave determines the energy saving potential and payback time based on your application setup. SinaSave is a web tool which is intuitive to operate and supports you in an investment decision:

- Is it worthwhile to use more energy efficient systems?
- When will my investment pay off?

SinaSave supports you to find the optimum solution: technically, economically, and ecologically.



## In which cases can SinaSave support you?

- Motors
  - Calculate your potential energy savings and amortization times with SIMOTICS motors
- Pump systems
  - Calculate your potential energy and CO2 savings with our pump drive systems
- Fan systems
  - Calculate your potential energy and CO2 savings with our fan drive systems

## Access to the SinaSave energy efficiency tool

SinaSave can be accessed without the need for registration or logging in:

[www.siemens.com/sinasave](http://www.siemens.com/sinasave)

## Benefits

- **Transparency of overall savings potential and individual amortization plan**
  - SinaSave calculates the expected energy consumption and the resulting savings of energy, CO2 and energy cost, based on your individual energy prices, operating times and load profiles.
- **Support to find the optimum solution to make easy decision**
  - SinaSave directly compares your existing motors with SIMOTICS motors of various energy efficiency classes, for new systems and retrofits.
- **Ease of use and self-explanatory user guidance to calculate savings potential on overall system level**
  - SinaSave compares different drive system configurations for pump or fan applications. Regardless of greenfield or brown-field projects, SinaSave offers the flexibility to choose from different motor types and control modes, including variable speed drives and softstarters.
- **Well-structured SinaSave projects give you transparency of the savings potential of your entire facility**
  - SinaSave lets you combine several items in a single project. That means it's possible to reflect entire facilities and identify the savings potential they offer.

## Functions

- Determine savings potential for energy, power costs, and CO2
- Estimate expected amortization and Total Costs of Ownership (TCO)
- Output of system power losses for motor inverter systems as per IEC 61800-9-2
- Calculate possible financing, such as energy performance contracting (EnPC)
- Take government subsidies into account
- Simple design with intuitive usability
- Results presented in graphic form
- Save and load, share a handout e.g with your customer or decision-maker
- Eight languages, 14 currencies, IEC and NEMA standards
- Direct transfer to next processes, e.g. product configuration

## More information

Further information about the amortization calculator for energy-efficient drive systems is available on the Internet at:

[www.siemens.com/tools-sinasave](http://www.siemens.com/tools-sinasave)

Further information about services for energy saving is available on the Internet at:

[www.siemens.com/energy-saving](http://www.siemens.com/energy-saving)

[www.siemens.com/energy-efficiency](http://www.siemens.com/energy-efficiency)



## Engineering tools

### SIZER for Siemens Drives engineering tool (integrated in the TIA Selection Tool)

#### Overview

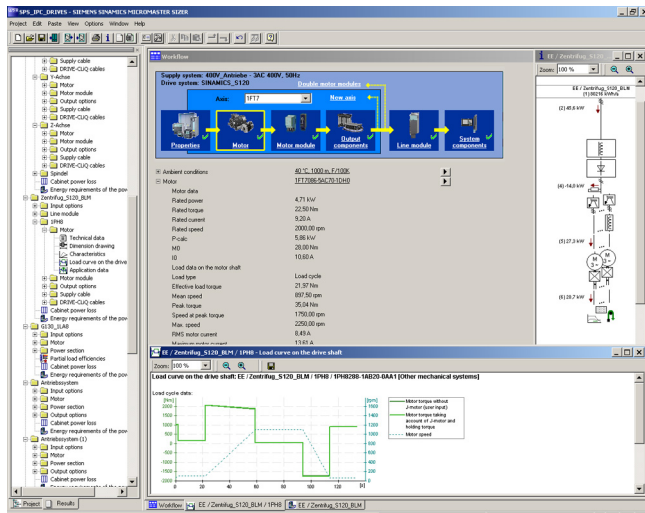

The following drives and controls can be engineered in a user-friendly way using the SIZER for Siemens Drives engineering tool:

- SIMOTICS motors, including servo geared motors
- SINAMICS low-voltage drive systems
- Motor starters
- SINUMERIK CNC
- SIMOTION Motion Control controller
- SIMATIC controller

It provides support when selecting the technologies involved in the hardware and firmware components required for a drive task. SIZER for Siemens Drives covers the full range of operations required to configure a complete drive system, from basic single drives to demanding multi-axis applications.

SIZER for Siemens Drives supports all of the engineering steps in one workflow:

- Configuring the power supply
- Designing the motor and gearbox, including calculation of mechanical transmission elements
- Configuring the drive components
- Compiling the required accessories
- Selecting the line-side and motor-side power options, e.g. cables, filters, and reactors

When SIZER for Siemens Drives was being designed, particular importance was placed on a high degree of usability and a universal, function-based approach to the drive application. The extensive user guidance makes it easy to use the tool. Status information keeps you continually informed about the progress of the configuration process.

The drive configuration is saved in a project. In the project, the components and functions used are displayed in a hierarchical tree structure.

The project view permits the configuration of drive systems and the copying/inserting/modifying of drives already configured.

The configuration process produces the following results:

- A parts list of the required components (export to Excel, use of the Excel data sheet for import to SAP)
- Technical specifications of the system
- Characteristic curves
- Comments on line harmonic distortions
- Mounting arrangement of drive and control components and dimensional drawings of motors
- Energy requirements of the configured application

These results are displayed in a results tree and can be reused for documentation purposes.

Support is provided by the technological online help menu:

- Detailed technical specifications
- Information about the drive systems and their components
- Decision-making criteria for the selection of components
- Online help in English, French, German, Italian, Chinese and Japanese

#### System requirements

- PG or PC, with Pentium III min. 800 MHz (recommended > 1 GHz)
- 512 MB RAM (1 GB RAM recommended)
- At least 2 GB of free hard disk space
- An additional 100 MB of free hard disk space on Microsoft Windows system drive
- Screen resolution 1024 × 768 pixels
- Operating system:
  - Microsoft Windows 7 (32/64-bit) Professional, Enterprise, Ultimate, Home
  - Microsoft Windows 8.1 (32/64-bit) Professional, Enterprise, Ultimate, Home
  - Microsoft Windows 365
  - Microsoft Windows 10 (64-bit) Professional, Enterprise
- Microsoft Office 2003/2007/2010/2013/2016/365
- Microsoft Internet Explorer V8.0
- Microsoft .NET Framework 2.0
- OpenGL 2.1

#### More information

##### Drive dimensioning in the TIA Selection Tool

Application-specific requirements can be determined using drive technology dimensioning in the TIA Selection Tool. This can include motors, gearboxes and converters. The tool supports the configuration and dimensioning of control functions with an open and closed control loop. The technical documentation with features of the technical drive system, as well as a product list for ordering via SiePortal can also be compiled.

You can find more information on the SIZER for Siemens Drives engineering tool at

<https://support.industry.siemens.com/cs/ww/en/ps/13434/dl>

You can find more information about the TIA Selection Tool at: [www.siemens.com/tia-selection-tool](http://www.siemens.com/tia-selection-tool)

## SINAMICS web server for SINAMICS G120X via SINAMICS G120 Smart Access

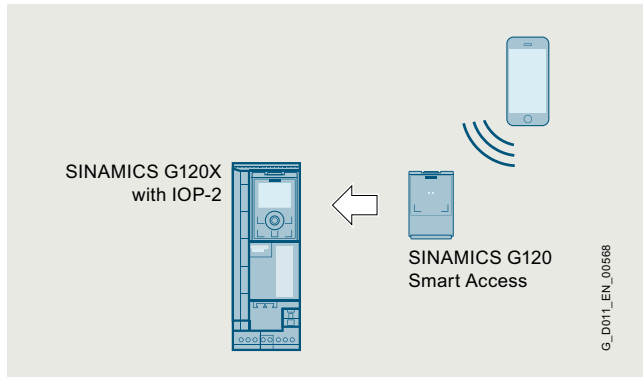
**Overview****Web server for efficient commissioning, diagnostics and maintenance**

SINAMICS G120X with IOP-2 and SINAMICS G120 Smart Access

Thanks to the optionally available SINAMICS G120 Smart Access, the SINAMICS G120X drive system offers a web server for efficient commissioning, diagnostics and maintenance options. The web server provides access to a multi-faceted range of new options for parameter assignment and drive diagnostics for laptops, tablets and smartphones, including:

- Simple and fast commissioning
- Drive traversing via the control panel
- Downloading/uploading a configuration
- Providing a status overview of the drive
- Evaluating warnings and fault messages
- Monitoring and adapting parameter settings

**Benefits****Simple and fast commissioning**

- No installation of additional commissioning software
- Standard pages for limit values and settings
- Comprehensive fault diagnosis

**Direct language selection**

- English, German, French, Italian, Spanish, Chinese

**Accessibility**

- Free choice of terminal devices as the web server works with all common web browsers, such as iOS, Android, Microsoft Windows, Linux and Mac OS

**Diagnostic functions**

- Quick overview of the current configuration and the state of the drive
- Understandable diagnostic information and messages, including the causes of issues and possible remedies, are displayed in plain text in multiple languages

**Freely configurable parameter lists**

- Monitoring parameters for diagnostic purposes, for example for operating personnel
- Adjustment of the parameter lists using filters, parameter groups and the configuration of personal lists

**Access security**

- Protection against unauthorized access to the drive information

**Application**

The web server is ideal for applications in which special commissioning software or version dependencies are not desired. Easy commissioning, diagnostics and maintenance are possible locally, provided appropriate security measures are applied.

## Engineering tools

### Notes

3

## Services and documentation



<b>4/2</b>	<b>Partner</b>
<b>4/3</b>	<b>Industry Services</b>
4/4	Industry Services – Portfolio overview
4/5	Online Support
<b>5/6</b>	<b>Training</b>
5/6	SITRAIN – Digital Industry Academy
4/8	Training courses for SINAMICS low-voltage converters
4/9	SINAMICS G120X training case
<b>4/10</b>	<b>Control cabinets</b>
<b>4/12</b>	<b>Applications</b>
<b>4/13</b>	<b>Field and maintenance services</b>
4/13	General overhaul
4/13	Function check
<b>4/14</b>	<b>Spare parts services</b>
4/14	Delivery of spare parts
4/15	Delivery as exchange product
4/15	Component upgrade service
4/16	Return of diagnostic parts
4/16	Stock reduction in spare parts store
4/16	Extended spare part availability
<b>4/17</b>	<b>Repair services</b>
<b>4/18</b>	<b>Spares on Web</b>
<b>4/19</b>	<b>Drives Options Partner</b>
<b>4/20</b>	<b>mySupport documentation</b>
<b>4/21</b>	<b>Documentation</b>
4/21	General documentation
4/22	SINAMICS G120X documentation

# Services and documentation

## Partner

### Overview

#### Partner at Siemens

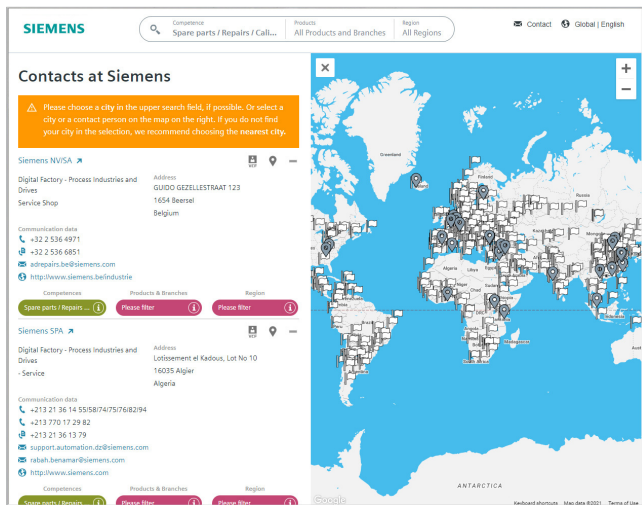

At your service locally, around the globe for consulting, sales, training, service, support, spare parts on the entire portfolio of Siemens.

Your partner can be found in our Personal Contacts Database at: [www.siemens.com/automation-contact](http://www.siemens.com/automation-contact)

You start by selecting

- the required competence,
- products and branches,
- a country and a city

or by a

location search or free text search.

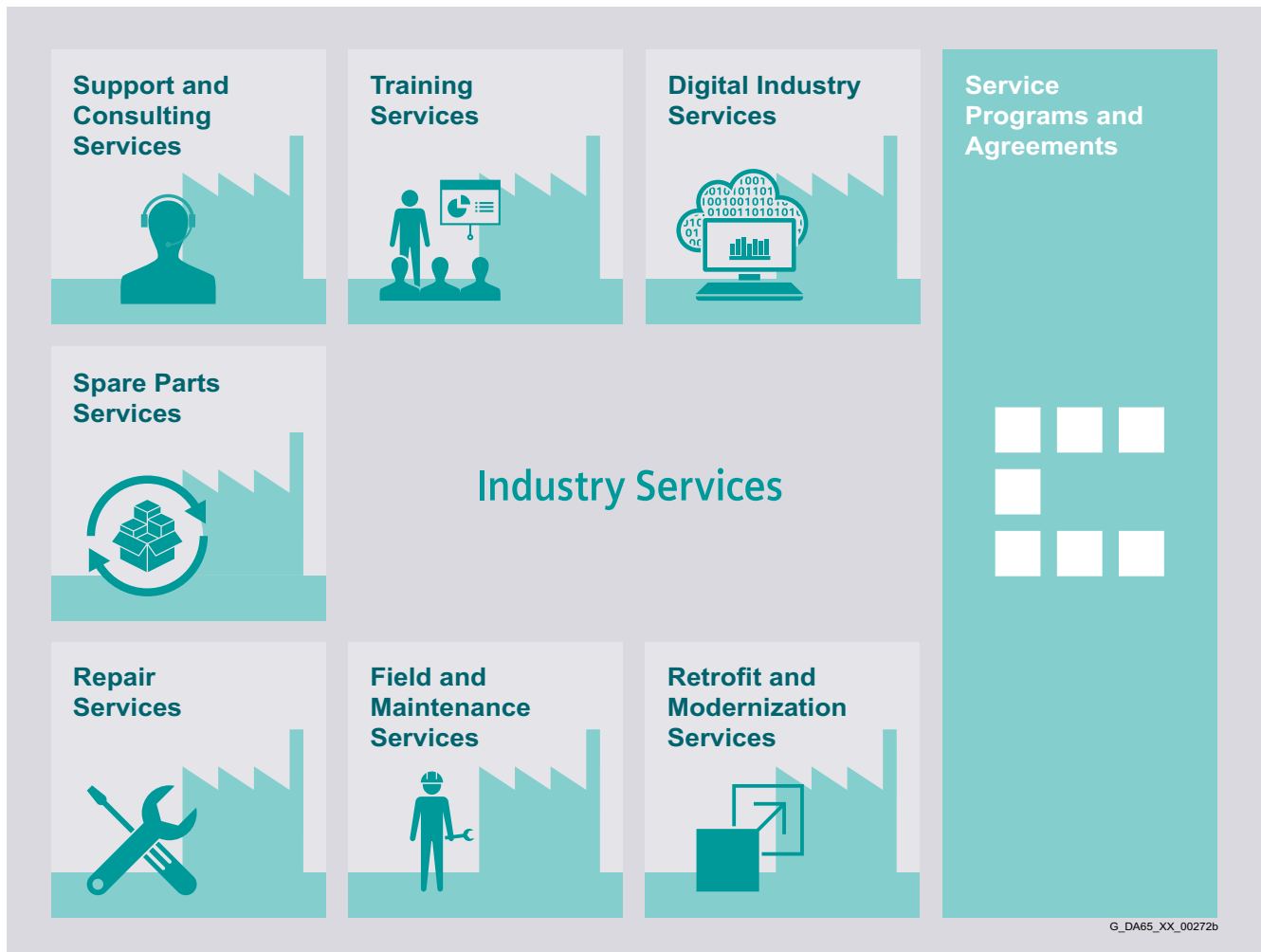
**Overview**

**Keep your business running and shaping your digital future – with Industry Services**

Optimizing the productivity of your equipment and operations can be a challenge, especially with constantly changing market conditions. Working with our service experts makes it easier. We understand your industry's unique processes and provide the services needed so that you can better achieve your business goals.

You can count on us to maximize your uptime and minimize your downtime, increasing your operations' productivity and reliability. When your operations have to be changed quickly to meet a new demand or business opportunity, our services give you the flexibility to adapt. Of course, we take care that your production is protected against cyber threats. We assist in keeping your operations as energy and resource efficient as possible and reducing your total cost of ownership. As a trendsetter, we ensure that you can capitalize on the opportunities of digitalization and by applying data analytics to enhance decision making: You can be sure that your plant reaches its full potential and retains this over the longer lifespan.

You can rely on our highly dedicated team of engineers, technicians and specialists to deliver the services you need – safely, professionally and in compliance with all regulations. We are there for you, where you need us, when you need us.

[www.siemens.com/digital-enterprise-services](http://www.siemens.com/digital-enterprise-services)



## Services and documentation

### Industry Services

#### Industry Services – Portfolio overview

##### Overview



#### Digital Industry Services

Digital Industry Services make your industrial processes transparent to gain improvements in productivity, asset availability, and energy efficiency.

Production data is generated, filtered and translated with intelligent analytics to enhance decision-making.

This is done whilst taking data security into consideration and with continuous protection against cyber-attack threats.

[www.siemens.com/digital-enterprise-services](http://www.siemens.com/digital-enterprise-services)

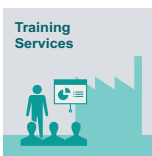

#### Training Services

From the basics and advanced to specialist skills, SITRAIN courses provide expertise right from the manufacturer – and encompass the entire spectrum of Siemens products and systems for the industry.

Worldwide, SITRAIN courses are available wherever you need a training course in more than 170 locations in over 60 countries.

<https://support.industry.siemens.com/cs/ww/en/sc/2226>



#### Support and Consulting Services

**Industry Online Support** site for comprehensive information, application examples, FAQs and support requests.

**Technical and Engineering Support** for advice and answers for all inquiries about functionality, handling, and fault clearance. The Service Card as prepaid support for value added services such as Priority Call Back or Extended Support offers the clear advantage of quick and easy purchasing.

**Information & Consulting Services**, e.g. SIMATIC System Audit; clarity about the state and service capability of your automation system or Lifecycle Information Services; transparency on the lifecycle of the products in your plants.

<https://support.industry.siemens.com/cs/ww/en/sc/2235>



#### Spare Parts

Spare Parts Services are available worldwide for smooth and fast supply of spare parts – and thus optimal plant availability. Genuine spare parts are available for up to ten years. Logistic experts take care of procurement, transport, custom clearance, storage and order management.

Reliable logistics processes ensure that components reach their destination as needed.

Since not all spare parts can be kept in stock at all times, Siemens offers a preventive measure for spare parts provisioning on the customer's premises with optimized **Spare Parts Packages** for individual products, custom-assembled drive components and entire integrated drive trains – including risk consulting.

**Asset Optimization Services** help you design a strategy for parts supply where your investment and carrying costs are reduced and the risk of obsolescence is avoided.

<https://support.industry.siemens.com/cs/ww/en/sc/2110>



#### Repair Services

Repair Services are offered on-site and in regional repair centers for fast restoration of faulty devices' functionality.

Also available are extended repair services, which include additional diagnostic and repair measures, as well as emergency services.

<https://support.industry.siemens.com/cs/ww/en/sc/2154>



#### Field and Maintenance Services

Siemens specialists are available globally to provide expert field and maintenance services, including commissioning, functional testing, preventive maintenance and fault clearance.

All services can be included in customized service agreements with defined reaction times or fixed maintenance intervals.

<https://support.industry.siemens.com/cs/ww/en/sc/2265>



#### Retrofit and Modernization Services

Provide a cost-effective solution for the expansion of entire plants, optimization of systems or upgrading existing products to the latest technology and software, e.g. migration services for automation systems.

Service experts support projects from planning through commissioning and, if desired over the entire extended lifespan, e.g. Retrofit for Integrated Drive Systems for an extended lifetime of your machines and plants.

<https://support.industry.siemens.com/cs/ww/en/sc/2286>



#### Service Programs and Agreements

A technical Service Program or Agreement enables you to easily bundle a wide range of services into a single annual or multi-year agreement.

You pick the services you need to match your unique requirements or fill gaps in your organization's maintenance capabilities.

Programs and agreements can be customized as KPI-based and/or performance-based contracts.

<https://support.industry.siemens.com/cs/ww/en/sc/2275>

Overview

Online Support – fast, intuitive, whenever you want, wherever you need

**Web**

[www.siemens.com/online-support](http://www.siemens.com/online-support)

**App**

SIEMENS

Scan the QR code for information on our Online Support app.

- FAQ / Application examples**  
Information about industrial products, programming and configuration as well as application examples
- Technical information**  
Videos, documentation, manuals, updates, product notes, compatibility tool, certificates, planning data such as dimensional drawings, product data, 3D models
- Forum**  
Exchange information and experience with other users and experts

## Online Support for Siemens Industry Products

Siemens Industry and Online Support with some 1.7 million visitors per month is one of the most popular web services provided by Siemens. It is the central access point for comprehensive technical know-how about products, systems and services for automation and drives applications as well as for process industries.

In connection with the challenges and opportunities related to digitalization you can look forward to continued support with innovative offerings.

## Services and documentation

### Training

#### SITRAIN – Digital Industry Academy

##### Introduction

##### *Learn the way you like it – with SITRAIN*

SITRAIN imparts a wide range of technical knowledge for all industries and applications. Our offering is oriented toward the needs of learners and the demands of innovative companies. Get pleasure out of learning - thanks to innovative learning methods, personal support, and knowledge that will help you in your work and further development. For successful, flexible, and continuous learning.

##### *Education and training directly from the manufacturer*

SITRAIN provides you with training from the industrial product and solution portfolio from Siemens and benefits from 30 years of expertise in technical training. Take a look at the many options for expanding your knowledge with SITRAIN and find the course that meets your needs! The following training and further education units are available to you for your individual knowledge building:



##### **Industrial Automation Systems SIMATIC**

Training available for: SIMATIC S7-1500, TIA Portal, SIMATIC S7-300/400, SIMATIC S7-1200



##### **Drive Technology**

Training available for: SINAMICS S120 and SINAMICS G120 low-voltage converters, SINAMICS G130 / G150 / G180 / S150

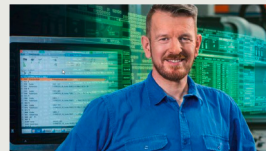

##### **SINUMERIK CNC automation system**

Training available for: SINUMERIK 840D, SINUMERIK 840D sl and SINUMERIK ONE



##### **Process Control Systems**

Training available for: SIMATIC PCS 7, SIMATIC PCS neo



##### **Digital Enterprise**

Training available for: Openness, SIMIT, OPC UA, Industrial Edge, Virtual commissioning



##### **Industrial Communications**

Training available for: PROFINET, SCALANCE, RUGGEDOM, Industrial Ethernet, Fieldbus communication, Industrial Security, Remote communication

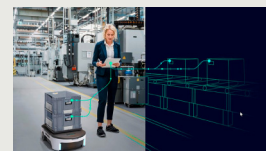

##### **Identification and Locating**

Training available for: RFID, RTLS-Systems



##### **Operator Control and Monitoring Systems**

Training available for: SIMATIC WinCC Unified in TIA Portal, SIMATIC WinCC in TIA Portal, SIMATIC WinCC V7x



##### **Motion Control System SIMOTION**

Training available for: SIMOTION (Programming, Commissioning, Diagnostics, Service)



##### **Smart Infrastructure**

Training available for: SIRIUS, SENTRON, SIVACON, ALPHA, SIMOCODE, Circuit breakers



##### **Process Analytics & Instrumentation**

Training is available for process analytics and instrumentation, explosion protection, process gas chromatographs



##### **Additional training offer**

SIMOVE with Automated Guided Vehicles (AGV), SIPLUS CMS, Guidelines and standards for control cabinets



**Introduction**

**Different learning formats and methods for maximum learning success**

With our SITRAIN training formats, you learn in the way that best suits your preferences and routine. You decide whether you would rather take online training or face-to-face training. It is up to you whether you would like to study on demand or at fixed times.

With a personal learning consultant, in the team, or on your own – you can explore all the possibilities.

Discover our three learning formats:



**Learning Event**

SITRAIN Learning Events are the perfect choice when you want to achieve a defined learning goal in the shortest possible time. You learn in a protected learning environment outside of the daily work routine under the guidance of a learning consultant - virtually, in the training center, or at your company.



**Learning Membership  
SITRAIN Access**

With SITRAIN access, you enter a world of extensive and constantly expanding self-study units on our digital learning platform for industry. With SITRAIN access, you can implement a modern learning culture in your team or company with independent and continuous learning.



**Learning Journey**

The Learning Journey is the perfect combination of units taken live and self-study units for sustainable learning success. The modular approach enables simple integration into your daily work. This also includes one-year membership for using the SITRAIN access digital learning platform.

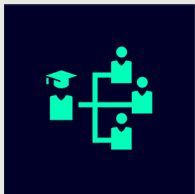

**Live**

Learn together with others, simultaneously and guided by a learning consultant. Online, in the SITRAIN training center or at your company.



**Self-reliant**

Expand your knowledge self-determined with industry learning and work on your learning units at your own pace and according to your own schedule.

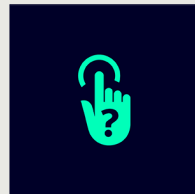

**On demand**

Get the knowledge you need, exactly when you need it. Be it to answer a current question or to work on a special topic.

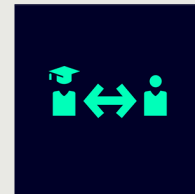

**Individual**

Talk directly with the learning consultant, clarify detailed questions and get personal coaching for transferring the learned topics to your own application.



**Training cases catalog**

[www.siemens.com/sitrain-catalog-training-cases](http://www.siemens.com/sitrain-catalog-training-cases)

[www.siemens.com/sitrain](http://www.siemens.com/sitrain)

Find your local offer here



## Services and documentation

### Training

#### Training courses for SINAMICS low-voltage converters

##### Overview

##### Training courses for SINAMICS drive system



This provides an overview of the training courses available for the SINAMICS drive system.

The courses are modular in design and are directed at a variety of target groups as well as individual customer requirements.

The system overview will acquaint decision-makers and sales personnel with the system very quickly.

The engineering course provides all the information you need to configure the drive system.

The courses dedicated to diagnostics and servicing, parameterization and commissioning, communication as well as extended functions such as Safety Integrated are sure to provide all the technical knowledge service engineers will need.

All courses contain as many practical exercises as possible to enable intensive and direct training on the drive system and with the tools in small groups.

Please also take note of the training options available for SIMOTICS motors. You will find more information about course contents and dates on the internet.

Title (all courses are available in English and German)	Target group			Duration	Order code
	Planners, decision-makers, sales personnel	Commissioning engineers, configuring engineers	Service personnel, maintenance technicians		
<b>Course Fundamentals and overview</b>					
SINAMICS and SIMOTICS - Basics of drive technology	✓	✓	✓	5 days	DR-GAT
<b>Courses SINAMICS S120</b>					
SINAMICS S120 Designing and Engineering	✓	–	–	5 days	DR-S12-PL
SINAMICS S120 Parameterizing and Commissioning with STARTER	–	✓	–	5 days	DR-S12-PM
SINAMICS S120 Parameterizing and Commissioning in the TIA Portal	–	✓	–	5 days	DR-S12-PMT
SINAMICS S120 Parameterizing Safety Integrated	–	✓	–	4 days	DR-S12-SAF
SINAMICS S120 Parameterizing and Optimization	–	✓	–	5 days	DR-S12-OPT
SINAMICS S120 Diagnostics and Service	–	–	✓	5 days	DR-S12-DG
SINAMICS S120 Diagnostics and Service in the TIA Portal	–	–	✓	5 days	DR-S12-DGT
SINAMICS S120 Diagnostics on Chassis and Cabinet Units	–	✓	✓	3 days	DR-S12-CHA
<b>Course SINAMICS G120 (including SINAMICS G120X, SINAMICS G120D and SINAMICS G115D)</b>					
Parameterizing and Commissioning	–	✓	–	2 days	DR-G12-PM
<b>Courses SINAMICS G130/G150/G180/S150</b>					
SINAMICS G150/G130/S150 - Diagnostics and Service	–	✓	✓	5 days	DR-G15-DG
SINAMICS G180 - Diagnostics and Service	–	–	✓	2.5 days	DR-G18-DG

## Overview



SINAMICS G120X training case

The SINAMICS G120X training case is a convincing demonstration system thanks to its compact design. It is suitable for direct customer presentations as well as for tests in technical departments. It enables the functions of SINAMICS G120X to be demonstrated and tested quickly and easily.

It contains the following components:

- SINAMICS G120X frequency converter, PROFINET, EtherNet/IP, 0.75 kW
- Operator panels IOP-2
- SINAMICS G120 Smart Access
- Asynchronous (induction) motor

The SINAMICS G120X training case is supplied as a trolley with a hood.

## Technical specifications

<b>SINAMICS G120X training case</b>	
6AG1067-2AA00-0AC1	
<b>Supply voltage</b>	230 V 1 AC
<b>Dimensions</b>	
• Width	290 mm (11.42 in)
• Height	470 mm (18.50 in)
• Depth	300 mm (11.81 in)
<b>Weight, approx.</b>	16.9 kg (37.26 lb)

## Selection and ordering data

Description	Article No.
<b>SINAMICS G120X training case</b>	<b>6AG1067-2AA00-0AC1</b>



## Services and documentation

### Control cabinets

#### Overview

##### **Complete equipment for machine tools and production systems**

Our supplied range of products and services also includes complete equipment for machine tools and production systems with all services in the process chain from consulting through to after-sales service.

We support you in the areas of engineering, production and logistics.

##### **Engineering support**

Siemens supports you with advice on design in accordance with standards and concepts for drive systems, control, operation and safety.

Our engineers configure for you in EPLAN P8 and other commonly used CAD systems, execute projects designed to cost and adapt your documents where necessary to UL or new systems.

Our Technical Competence Center Cabinets in Chemnitz supports you with selecting and optimizing the suitable control cabinet air-conditioning system. Apart from calculation and simulation, we also use instrumentation testing in our heat laboratory with load simulation.

We also offer the following services:

- Vibration measurements and control cabinet certification in the field
- Measurement of conducted interference voltages in our laboratory



Cabinet engineering

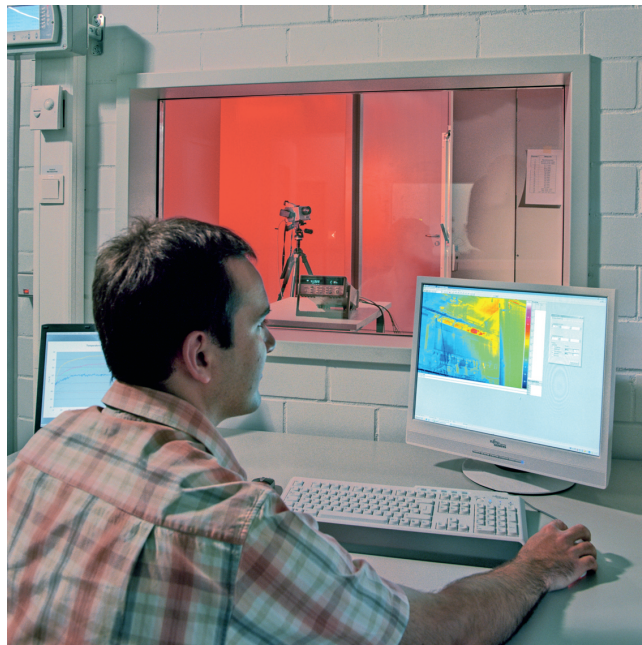

Testing in the heat laboratory

##### **Production at a high level of quality**

Complete equipment is manufactured at a high industrial level. This means:

- Examining consistency of the order documentation
- Checking for adherence to current regulations
- Collision check in 3D layout, taking into account the free space required thermally and electrically
- Automatic preparation of enclosures, cables and cable bundles
- Automated inspection and shipment free of faults
- Documentation and traceability
- Declaration of conformity regarding the Low-Voltage Directive and manufacturer's declaration on machinery directive
- UL label on request

##### **Superior logistics**

Everything from a single source offers you the following advantages:

- Cost savings for procurement, stockkeeping, financing
- Reduction in throughput times
- Just-in-time delivery

##### **Individual support and maximum flexibility**

Our technical consultants for complete equipment support customers and sales departments in the various regions. Our control cabinet customers are supported in the Systems Engineering Plant Chemnitz (WKC) by ordering centers and production teams that are permanently assigned to customers.

Distance does not present a problem; we also use web cams for consulting our customers.

### Overview



Worldwide repair service

Customer-specific logistics models, flexible production capacity and production areas as well as change management in all process phases ensure maximum flexibility.

#### **Customized supplementary products**

As part of its complete equipment program, Siemens also offers the development and construction of customized supplementary products, e.g. special operator panels and power supply systems.

#### **Liability for defects**

Of course we accept the same liability for defects for our complete equipment as for our SINUMERIK and SINAMICS products.

Furthermore, you can use our worldwide repair service anywhere and at any time.

#### **Your benefits**

One partner, one quotation, one order, one delivery, one invoice, and one contact partner for liability of defects.

For series production or individual items, Siemens is your competent partner for complete equipment.

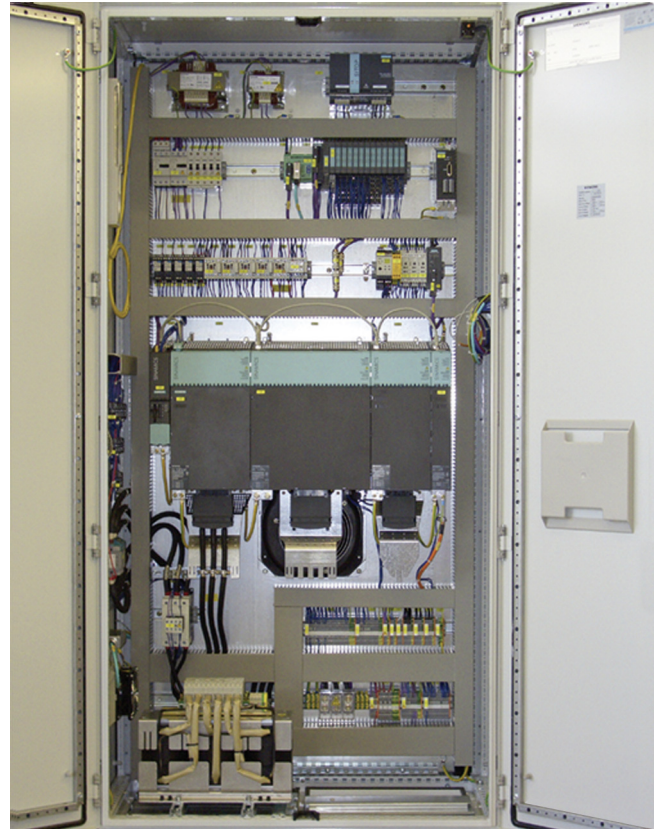

Control cabinet with SINAMICS S120 in bookshelf format



## Services and documentation

### Applications

#### Overview



Our understanding of an application is the customer-specific solution of an automation task based on standard hardware and software components. In this respect, industry knowledge and technological expertise are just as important as expert knowledge about how our products and systems work. We are setting ourselves this challenge with more than 280 application engineers in 20 countries.

#### Application centers

We currently have application centers in:

- Germany:
  - Head Office in Erlangen and in other German regions, e.g. in Munich, Nuremberg, Stuttgart, Mannheim, Frankfurt, Chemnitz, Cologne, Bielefeld, Bremen, Hanover, Hamburg
- Belgium: Brussels
- Brazil: Sao Paulo
- China: Beijing and 12 regions
- Denmark: Ballerup
- France: Paris
- Great Britain: Manchester
- India: Mumbai
- Italy: Bologna, Milan
- Japan: Tokyo, Osaka
- The Netherlands: The Hague
- Austria: Vienna
- Poland: Warsaw
- Sweden: Göteborg
- Switzerland: Zurich, Lausanne
- Spain: Madrid
- South Korea: Seoul
- Taiwan: Taipei
- Turkey: Istanbul
- USA: Atlanta

These application centers specialize in the use of SIMATIC/SIMOTION/SINAMICS. You therefore can rely on automation and drive specialists for implementing successful applications. By involving your personnel at an early stage in the process, we can provide a solid basis for rapid knowledge transfer, maintenance and further development of your automation solution.

#### Advice on applications and implementation

We offer a variety of consultation services to help you find the optimum solution for the SIMATIC/SIMOTION/SINAMICS application you want to implement:

The quotation phase includes

- clarification of technical questions,
- discussion of machine concepts and customer-specific solutions,
- selection of suitable technology and
- suggestions for implementation.

A technical feasibility study is also performed at the outset. In this way, difficult points of the application can be identified and solved early on. We can also configure and implement your application as a complete solution from a single source.

A large number of proven standard applications are available for use during the implementation phase. This saves engineering costs.

The system can be commissioned by experienced, competent personnel, if required. This saves time and trouble.

If servicing is required, we can support you on site or remotely. For further information about servicing, please see the section "Industry Services".

#### On-site application training

Training for the implemented applications can also be organized and carried out on site. This training for machine manufacturers and their customers does not deal with individual products, but the entire hardware and software system (for example, automation, drives and visualization).

From an initial concept to successful installation and commissioning: We provide complete support for SIMATIC/SIMOTION/SINAMICS! Contact your Siemens representative.

You can find further information at [www.siemens.com/machinebuilding](http://www.siemens.com/machinebuilding)

#### Overview

##### Efficient and cost-effective maintenance strategies for the entire product lifecycle



For you as an industry plant operator, maximum system productivity is your top priority.

Regular machine and plant maintenance performed by qualified service experts helps you ensure top plant performance for the long term.

For more information visit us at:  
[www.siemens.com/field-maintenance-services](http://www.siemens.com/field-maintenance-services)

#### General overhaul

#### Overview

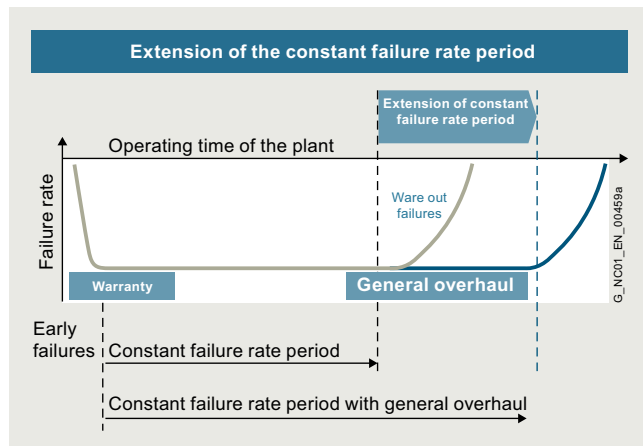

Extension of phases with a constant failure rate

Machines and plants are expected to have a long service life. The service life of electronic components and mechanical parts is, however, limited and normally shorter than the planned machine/plant operating times. For higher availability of the machines or plants, we offer a general overhaul (preventive maintenance) for electronic components and motors at favorable conditions.

During the planned general overhaul, wear parts and aging parts are replaced in accordance with their stated service life so as to reduce unplanned downtimes. In the case of motors, replacement of bearings and encoders is also offered in addition to a general overhaul.

If a fault is detected during a general overhaul, troubleshooting and repair will be performed after requesting confirmation.

In the case of severe wear or major damage, we offer an "as new" spare part instead of a general overhaul for reasons of quality.

#### Benefits

- Preventive replacement of wear parts and aging parts in accordance with their stated service life
- Reduction in unplanned plant stoppages
- Enhanced production reliability
- Extended availability of your machines/plants
- New liability for defects for 12 months for components which have undergone a general overhaul
- Low price

#### More information

You can find more information on the internet at:  
<https://support.industry.siemens.com/cs/sc/2120>

Contact information for your local Siemens office or national company is available on the internet at:  
[www.siemens.com/automation-contact](http://www.siemens.com/automation-contact)

#### Function check

#### Overview

A check is made to ensure that the components function reliably. The first step involves cleaning the components. After that, all hardware, software and firmware enhancements are implemented that are known to the development, production, suppliers, service and quality management departments. Using a comprehensive test concept of series production, all functions of the software, firmware, ASICs, and complex and less complex function blocks are checked.

If a fault is detected during an overhaul, troubleshooting and repair will be performed after requesting confirmation. In the case of severe wear or major damage, we offer an "as new" spare part.

#### Benefits

- The component is checked and can be deployed again
- The component contains all the known improvements
- The customer's own spare parts stock is up-to-date
- Low price

#### More information

You can find more information on the internet at:  
<https://support.industry.siemens.com/cs/sc/2122>

Contact information for your local Siemens office or national company is available on the internet at:  
[www.siemens.com/automation-contact](http://www.siemens.com/automation-contact)

## Services and documentation

### Spare parts services

#### Overview

##### *Be safe in an emergency – always the right spare part at hand*



Minimum downtimes and optimum use of staff and equipment are key to long-term success in industry.

But when a failure happens, it can bring the entire plant to a standstill in the worst case. Since even the best components will eventually reach the end of their lifecycle, our Spare Parts Services form the essential basis for smooth operation.

For more information visit us at:  
[www.siemens.com/spare-parts-services](http://www.siemens.com/spare-parts-services)

#### Delivery of spare parts

#### Overview

In every sector worldwide, plants and systems are required to operate with ever increasing availability. Not having a specific spare part at the right time can result in considerable costs.

We will provide you with the support you need to prevent a standstill from occurring in the first place: with a worldwide network and optimized logistics chains.

Order type	Logistics service	Remark
Standard	Cost-optimized: Contracted shipping company	Delivery within the normal national delivery times by the contracted shipping company
Plant downtime	Time-optimized: Express, courier, collection	You choose the shortest possible delivery time as it suits you best: <ul style="list-style-type: none"> <li>• Delivery by means of collection or courier service</li> <li>• Delivery by means of express delivery</li> </ul>
Emergency service	Special logistics: Courier	Spare parts can be ordered from us 24/7 – even outside normal working hours, as well as on weekends or national holidays. <ul style="list-style-type: none"> <li>• Delivery by means of courier service</li> </ul>

#### Benefits

- New liability for spare part defects
- Long-term spare parts availability
- Optimum system compatibility

#### More information

You can find more information on the internet at:  
<https://support.industry.siemens.com/cs/sc/2112>

Contact information for your local Siemens office or national company is available on the internet at:  
[www.siemens.com/automation-contact](http://www.siemens.com/automation-contact)

#### Overview

With many products, we also offer you the option of an exchange in addition to the simple delivery of spare parts. This has the advantage that you not only receive the spare part quickly, but are able to return the defective device to us for a credit. You therefore receive our spare part at the lower exchange price.

A credit will be awarded on condition that the repair code indicates that repurchasing is admissible, a replacement is obtained from the spare parts store, and that the returned product is repairable.

The order type and logistics service determine the delivery of spare parts:

Order type	Logistics service	Remark
Standard	Cost-optimized: Contracted shipping company	Delivery within the normal national delivery times by the contracted shipping company
Plant downtime	Time-optimized: Express, courier, collection	You choose the shortest possible delivery time as it suits you best: <ul style="list-style-type: none"> <li>• Delivery by means of collection or courier service</li> <li>• Delivery by means of express delivery</li> </ul>
Emergency service	Special logistics: Courier	Spare parts can be ordered from us 24/7 – even outside normal working hours, as well as on weekends or national holidays. <ul style="list-style-type: none"> <li>• Delivery by means of courier service</li> </ul>

#### Return

For product returns, we require the following information:

- Reason for return
- If defective: detailed description of the fault
- Machine number
- Machine/system manufacturer
- End user

We will then be able to provide you with additional information in the repair report/inspection report regarding the diagnosis/inspection as well as information about the completed repair.

#### Benefits

- Price benefits through the option of returning defective parts
- A spare part is available immediately in the event of failure
- New liability for spare part defects
- Long-term spare parts availability
- Optimum system compatibility

#### More information

You can find more information on the internet at:  
<https://support.industry.siemens.com/cs/sc/2112>

Contact information for your local Siemens office or national company is available on the internet at:  
[www.siemens.com/automation-contact](http://www.siemens.com/automation-contact)

#### Overview

##### **Upgrade service for components: From OLD to NEW**

Machines and plant are expected to have a long service life. The service life of the electronic components is, however, limited and normally shorter than the planned machine/plant operating times. To ensure that the required extended availability of the machines/plants is achieved, we offer an upgrade service for components at an attractive price.

In the course of their lifecycle, electronic components are normally redesigned/upgraded several times. With the upgrade service for components, you will always receive the latest technology.

A planned component upgrade from OLD to NEW helps to prevent unplanned machine stoppages and supports a safer and longer machines/plant availability. The upgrade service is mainly offered for older components that will soon be discontinued.

For information about the latest potential upgrades, please contact your local contact person. The upgrade service for components can only be offered to machine manufacturers or operators.

#### Benefits

- Price benefit through upgrade service
- New liability for new component defects
- Extended availability of your machines/plants
- Prevention of component failures due to wear and aging
- Prevention of machine stoppages due to unavailability of spare parts
- Reduced spare parts inventories
- Latest technology
- Easier servicing due to fewer variants
- Industry Services through Siemens are assured for the future

#### More information

You can find more information on the internet at:  
<https://support.industry.siemens.com/cs/sc/2112>

Contact information for your local Siemens office or national company is available on the internet at:  
[www.siemens.com/automation-contact](http://www.siemens.com/automation-contact)



## Services and documentation

### Spare parts services

#### Return of diagnostic parts

##### Overview

Spare parts used for diagnostic purposes from the spare parts store can be returned within 3 months and a credit note for up to 85% is issued.

For unused spare parts in their original packaging, you will receive a credit of 100% in which case you will be charged a fixed price for handling.

##### Benefits

- Can be used for diagnostics
- Reduced spare parts inventories
- Low costs

##### More information

You can find more information on the internet at: <https://support.industry.siemens.com/cs/sc/2112>

Contact information for your local Siemens office or national company is available on the internet at: [www.siemens.com/automation-contact](http://www.siemens.com/automation-contact)

#### Stock reduction in spare parts store

##### Overview

Fast spare part delivery by Siemens enables manufacturers and plant operators to reduce their spare part stocks. For this purpose, we offer an analysis that shows exactly which parts should remain in the customer warehouse for a particular machine stock and which can be purchased directly from Siemens.

##### Benefits

- Reduced costs
- Stock optimization
- Minimization of fault downtimes

##### More information

You can find more information on the internet at: <https://support.industry.siemens.com/cs/sc/2112>

Contact information for your local Siemens office or national company is available on the internet at: [www.siemens.com/automation-contact](http://www.siemens.com/automation-contact)

## 4

#### Extended spare part availability

##### Overview

We normally retain spare parts for all products and systems for a period of 10 years after discontinuation of product marketing.

In individual cases, when we do not carry spare parts, we will offer a repair.

For a wide range of products and systems, spare parts availability is extended. We can provide you with the current spare parts availability for your machines/plants as a service once you have registered online with identSNAPSHOT.

[www.siemens.com/identsnapshot](http://www.siemens.com/identsnapshot)

If you require longer availability of spare parts for your machines/plants, please contact your local contact person.

##### Benefits

- Higher plant availability
- Security of investment
- Reduction of lifecycle costs

##### More information

You can find more information on the internet at: <https://support.industry.siemens.com/cs/sc/2112>

Contact information for your local Siemens office or national company is available on the internet at: [www.siemens.com/automation-contact](http://www.siemens.com/automation-contact)

### Overview

#### **High quality support in a breakdown – either at your premises or at a certified Siemens workshop**

Even the best components eventually reach the end of their lifecycle. The result: downtimes and reduced productivity.

Our Repair Services comprise all service tasks over the entire product lifecycle, from functional maintenance to increasing performance. In this way, our service experts analyze, repair, maintain and optimize your components at Siemens manufacturer level, so that costly downtimes are minimized.

For more information visit us at:  
[www.siemens.com/repair-services](http://www.siemens.com/repair-services)

Downtimes cause problems in the plant as well as unnecessary costs. We can help you to reduce both to a minimum – with our worldwide repair facilities. The advantages for you are: Defects can be rectified before they cause further harm.

Repair is a favorable option when you have specific reasons for not wanting to replace the defective device or part with a new one (delivery as exchange product).

We maintain a global network of Siemens repair shops and certified partners to ensure that we will always be able to process your repairs quickly.

We can offer you different types of repair depending on your requirements:

#### **Normal repair**

Normal repair at standard conditions normally takes 10 working days following receipt of the defective item at our repair shop.

#### **Fast repair**

In particularly urgent cases, we offer you the option of a fast repair within 1 or 2 working days for many products at additional cost.

#### **Mobile repair service**

We come to you and perform the required repairs on site, for example, when the device or component cannot be removed due to its weight.

#### **Function repair**

A function repair is the same as a normal repair but excludes the repair of cosmetic defects, e.g. scratches, inscriptions, discoloration. The conditions applicable to function repairs should be observed in this case. The function repair can only be offered to machine manufacturers or operators. Please contact your local contact person for more information.

#### **Long Life Repair**

As a rule, a spare parts and repair service is offered for electronics products for a period of up to ten years after the period of active marketing. After this time, these services are generally only available in the case of acknowledged warranty conditions. Not so at Siemens. The Long Life Repair Service is available for selected electronic products and standard motors. Siemens thus offers a complete solution that includes short delivery times, long availability of original spare parts, economical repairs and a service availability of up to 25 years.

### Benefits

- Short downtimes for machines and plants
- Only certified original parts are used
- Additional services from Siemens:
  - Longer availability of your machine/plant through the early replacement of wear parts and aging parts
  - Highest standards of quality
  - Use of the comprehensive test concept of series production, including software, firmware, ASICs, complex function blocks, etc.
  - Implementation of all the hardware and software/firmware enhancements known from development, production, suppliers, and service and quality management departments.
- Information supplied by repair report/inspection report

### More information

You can find more information on the internet at:  
<https://support.industry.siemens.com/cs/sc/3098>

Contact information for your local Siemens office or national company is available on the internet at:  
[www.siemens.com/automation-contact](http://www.siemens.com/automation-contact)

## Services and documentation

### Spares on Web

#### Overview

#### *Spares on Web – online identification of spare parts*

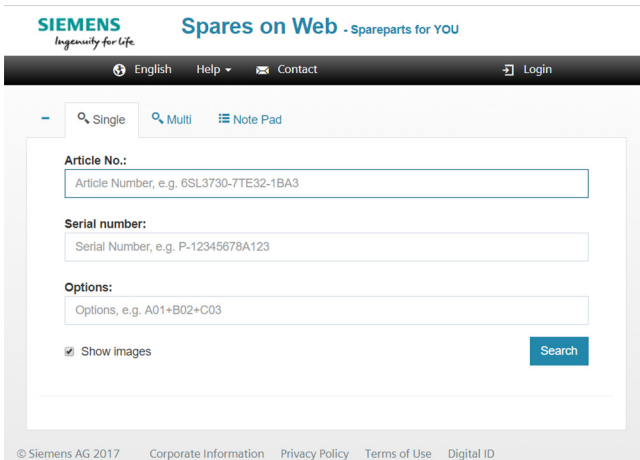

The screenshot displays the Siemens Spares on Web interface. At the top left is the Siemens logo with the tagline 'Ingenuity for Life'. The main heading is 'Spares on Web - Spareparts for YOU'. Below this is a navigation bar with 'English', 'Help', 'Contact', and 'Login'. The main search area has three tabs: 'Single', 'Multi', and 'Note Pad'. There are three input fields: 'Article No.' with a placeholder 'Article Number, e.g. 6SL3730-7TE32-1BA3', 'Serial number' with a placeholder 'Serial Number, e.g. P-12345678A123', and 'Options' with a placeholder 'Options, e.g. A01+B02+C03'. A 'Show images' checkbox is checked, and a blue 'Search' button is located to the right of the options field. At the bottom of the interface, there is a footer with '© Siemens AG 2017' and links for 'Corporate Information', 'Privacy Policy', 'Terms of Use', and 'Digital ID'.

Spares on Web is a web-based tool for identifying spare parts. After you have entered the Article No. and serial number, the spare parts available for the relevant unit are displayed.

[www.siemens.com/sow](http://www.siemens.com/sow)

## Overview

### Siemens Product Partners for Drives Options

#### Individual options for our drives

In order to meet as many customer requirements as possible in the field of drive technology, in addition to its own products, Siemens also relies on the individual and complementary services of selected partners.

We are increasingly focusing on the standard drive options, and our Siemens Product Partners for Drives Options supplement our drives with individual drive options.

This gives Siemens a unique flexibility to meet all application requirements. Naturally, we support our Siemens Product Partners for Drives Options in tailoring their options perfectly to our drives.

For you as our customer, there are multiple benefits:

- The Siemens Product Partners for Drives Options meet the same high standards of quality and performance that we place on our own products
- Drive options can be adapted to individual requirements/designs
- The Siemens Product Partners for Drives Options know our Siemens converter portfolio and can advise you individually and quickly

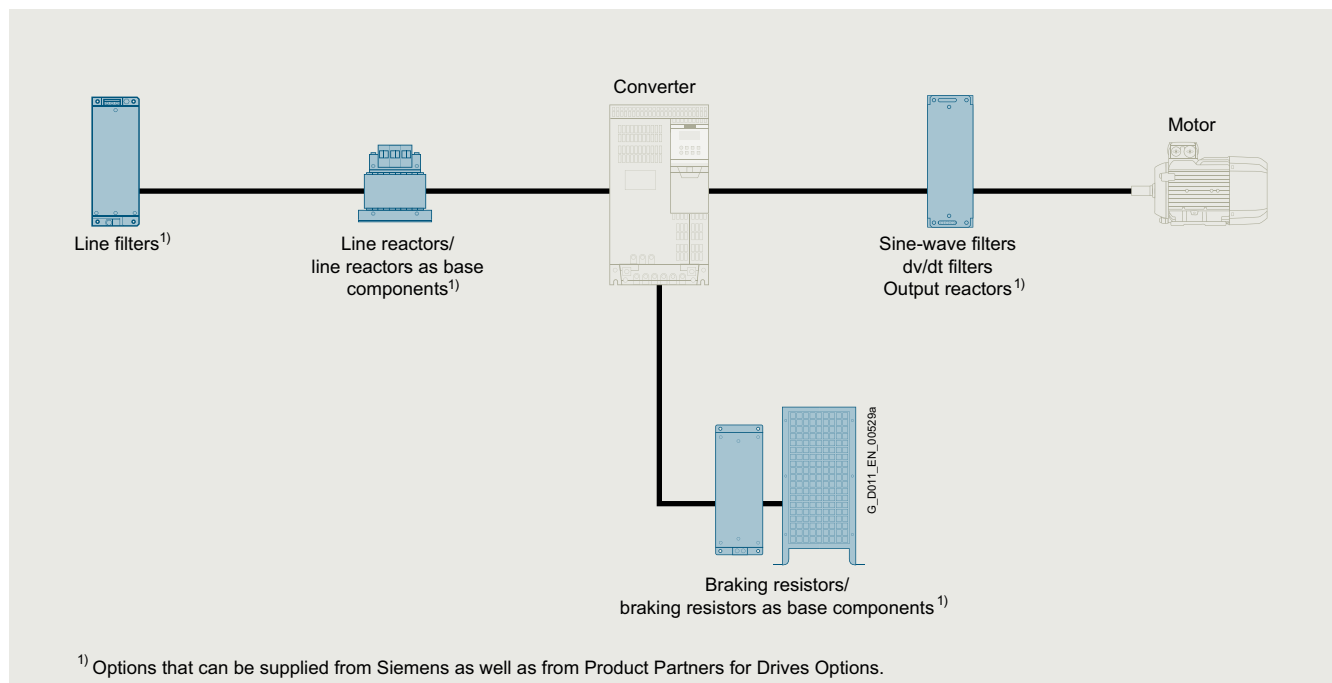

Schematic circuit diagram

### More information

You can find more information on the internet at [www.siemens.com/drives-options-partner](http://www.siemens.com/drives-options-partner)

## Services and documentation

### mySupport documentation

#### Overview

### mySupport documentation – Compiling personal documents

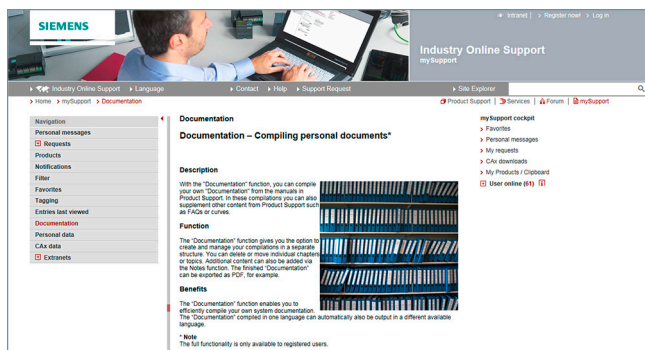

mySupport documentation is a web-based system for generating personalized documentation based on standard documents and is part of the Siemens Industry Online Support portal.

In mySupport, a personal document library can be created in the "Documentation" category. This library can be accessed online in mySupport or also be generated in various formats for offline use.

Previously, this functionality was available in the My Documentation Manager for configurable manuals. Due to the integration in mySupport, all entries of the Industry Online Support can now be imported into the personal document library, including FAQs or product notifications.

If you have already worked with the My Documentation Manager, all of the previously created libraries will continue to be available without restrictions in mySupport.

In addition, the personal library in mySupport can be shared with other mySupport users. In this way, a collection of relevant documents can be created very effectively and used together with other mySupport users all over the world.

You must register/log in for configuring and generating/managing.

#### Benefits

- Display  
View, print or download standard documents or personalized documents
- Configure  
Transfer standard documents or parts of them to personalized documents
- Generate/Manage  
Generate and manage personalized documents in the formats PDF, RTF or XML in all available languages

#### Function

##### Opening mySupport documentation in the Industry Online Support portal

- About the product support, entry type "Manual":  
<https://support.industry.siemens.com/cs/ww/en/ps/manual>  
By clicking on the required version of the manual and then "Show and configure", the manual opens in a modular view, where you can navigate from topic to topic. Here the direct link to a topic can be used and made available to other users. The selected document can be added to the personal library via "mySupport Cockpit" > "Add to mySupport documentation".
- Via the direct link  
<https://support.industry.siemens.com/my/ww/en/documentation/advanced>  
After logon/registration, the online help is displayed as the current document.

#### More information

You can find additional information on the internet at

- <https://support.industry.siemens.com/my/ww/en/documentation>
- [https://support.industry.siemens.com/cs/helpcenter/en/index.htm?#persoenliche\\_bibliothek\\_aufbauen.htm](https://support.industry.siemens.com/cs/helpcenter/en/index.htm?#persoenliche_bibliothek_aufbauen.htm)

## Overview

A high-quality programmable control or drive system can be used to maximum effect only if the user is aware of the performance of the products used as a result of intensive training and good technical documentation.

This is becoming more important due to the shorter innovation cycles of modern automation products and the convergence of electronics and mechanical engineering.

A comprehensive range of documentation is available which includes a Getting Started guide, operating instructions, installation manuals and a list manual.

In addition to technical information for SINUMERIK, SINAMICS, SIMOTION and SIMOTICS, the documentation is available for downloading as a PDF file from the internet:

- SINUMERIK  
<https://support.industry.siemens.com/cs/document/108464614>
- SINAMICS  
<https://support.industry.siemens.com/cs/document/109807358>
- SIMOTION  
<https://support.industry.siemens.com/cs/document/109479653>
- SIMOTICS  
<https://support.industry.siemens.com/cs/document/109813641>

## Application

### *Explanations of the manuals:*

- **Operating Instructions**  
contain all the information needed to install the device and make electrical connections, information about commissioning and a description of the converter functions.  
Phases of use: Control cabinet construction, commissioning, operation, maintenance and servicing.
- **Hardware Installation Manual**  
contains all relevant information about the intended use of the components of a system (technical specifications, interfaces, dimensional drawings, characteristics, or possible applications), information about installation and electrical connections and information about maintenance and servicing.  
Phases of use: Control cabinet configuration/construction, maintenance and servicing.
- **Operating and Installation Instructions**  
(for converter and accessories)  
contain all relevant information about the intended use of the components, such as technical specifications, interfaces, dimensional drawings, characteristics, or possible applications.  
Phases of use: Control cabinet configuration/construction.
- **Manual/Configuration Manual**  
contains all necessary information about the intended use of the components of a system, e.g. technical specifications, interfaces, dimensional drawings, characteristics, or possible applications.  
Phases of use: Cabinet configuration/setup, circuit diagram configuration/drawing.
- **Commissioning Manual**  
contains all information relevant to commissioning after installation and wiring. It also contains all safety and warning notices relevant to commissioning in addition to overview drawings.  
Phases of use: Commissioning of components that have already been connected, configuration of system functions.
- **List Manual**  
contains all parameters, function diagrams, and faults/alarms for the product/system as well as their meanings and setting options. It contains parameter data and fault/alarm descriptions with functional correlations.  
Phases of use: Commissioning of components that have already been connected, configuration of system functions, fault cause/diagnosis.
- **Getting Started**  
provides information about getting started for the first-time user as well as references to additional information. It contains information about the basic steps to be taken during commissioning. The information in the other documentation should be carefully observed for all of the other work required.  
Phases of use: Commissioning of components that have already been connected.
- **Function Manual Drive Functions**  
contains all the relevant information about individual drive functions: Description, commissioning and integration in the drive system.  
Phases of use: Commissioning of components that have already been connected, configuration of system functions.



## Services and documentation

### Documentation

#### General documentation

#### Selection and ordering data

Description	Article No.
<b>Automating with PROFINET: Industrial Communication Based on Industrial Ethernet</b> <ul style="list-style-type: none"> <li>• German</li> <li>• English</li> </ul>	Via bookstore  <b>ISBN 978-3-89578-293-0</b> <b>ISBN 978-3-89578-294-7</b>

#### SINAMICS G120X documentation

##### Overview

Identification link according to IEC 61406 for SINAMICS G120X

The ID link contains the article and serial number of the product. As a QR code, it replaces the previous data matrix code on the nameplate and takes you with the URL directly to a product information page on the internet with access to the technical documentation, data sheet, certificates, FAQs, product notifications, and catalogs. Paper package inserts become superfluous since the information is available electronically directly via the QR code, even years later. In this way, we are making a valuable contribution to the preservation of our environment. You don't need an additional app. Simply scan the QR code with your smartphone or tablet. According to IEC 61406, the QR code of an ID link is marked with a frame and a triangle at the bottom right.

With their globally unique identifiers, Siemens products are ready for Industry 4.0.

The ID serves as a connection to the administration shell with which modules of the digital twin can be provided.

Further documentation, such as the operating instructions, is available free on the internet at:

[www.siemens.com/sinamics-120x/documentation](http://www.siemens.com/sinamics-120x/documentation)

Detailed information on the SINAMICS G120X infrastructure converters for HVAC/Water/Wastewater, including the latest technical documentation (brochures, tutorials, dimensional drawings, certificates and operating instructions), is available on the internet at:

[www.siemens.com/sinamics-g120x](http://www.siemens.com/sinamics-g120x)

and is also available via the Siemens Product Configurator on the internet.

The Siemens Product Configurator can be found in SiePortal at the following address:

[www.siemens.com/spc](http://www.siemens.com/spc)

## Appendix



5/2	Certificates of suitability (approvals)
5/4	Software licenses
5/6	Conversion tables
5/8	Metal surcharges
5/11	Conditions of sale and delivery

## Appendix

### Certificates of suitability (approvals)







#### Overview

Many of the products in this catalog fulfill requirements, e.g. for UL, CSA or FM and are labeled with the corresponding approval designation.

All of the certificates of suitability, approvals, certificates, declarations of conformity, test certificates, e.g. CE, UL, Safety Integrated etc. have been performed with the associated system components as they are described in the Catalogs and Configuration Manuals.





The certificates are only valid if the products are used with the described system components, are installed according to the Installation Guidelines and used for their intended purpose.

In other cases, the vendor of these products is responsible for arranging for the issue of new certificates.

Test code	Tested by	Device series/ Component	Test standard	Product category/ File No.
<b>UL: Underwriters Laboratories</b> Independent public testing body in North America				
	UL according to UL standard	SINUMERIK	Standard UL 508, CSA C22.2 No. 142	NRAQ/7.E164110 NRAQ/7.E217227
		SIMOTION	Standard UL 508, CSA C22.2 No. 142	NRAQ/7.E164110
	UL according to CSA standard	SINAMICS	Standard UL 508, 508C, 61800-5-1 CSA C22.2 No. 142, 274	NRAQ/7.E164110, NMMS/2/7/8.E192450, NMMS/2/7/8.E203250, NMMS/7.E214113, NMMS/7.E253831
				NMMS/2/7/8.E121068 NMMS/7.E355661 NMMS/7.E323473
	UL according to UL and CSA standards	SIMODRIVE	Standard UL 508C, CSA C22.2 No. 274	NMMS/2/7/8.E192450 NMMS/7.E214113
				PRGY2/8.E227215 PRHZ2/8.E93429 PRHJ2/8.E342747 PRGY2/8.E253922 PRHZ2/8.E342746
	UL according to UL standard	SIMOTICS	Standard UL 1004-1, 1004-6, 1004-8, CSA C22.2 No. 100	PRGY2/8.E257852 XPTQ2/8.E103521 NMMS/2/8.E224872 XPTQ2/8.E354316 XPTQ2/8.E198309 XQNX2/8.E475972
				Line/motor reactors
	UL according to CSA standard	Line filters, dv/dt filters, sine-wave filters	UL 1283, CSA C22.2 No. 8	NMTR2/8.E224314 NMMS2/8.E192450 NMTR2/8.E221095 NMTR2/8.E226619
				Resistors
	UL according to UL and CSA standards	Resistors	UL 508, 508C, CSA C22.2 No. 14, 274	
<b>TUV: TÜV Rheinland of North America Inc.</b> Independent public testing body in North America, Nationally Recognized Testing Laboratory (NRTL)				
<b>TÜV: TÜV SÜD Product Service</b> Independent public testing body in Germany, Nationally Recognized Testing Laboratory (NRTL) for North America				
	TUV according to UL and CSA standards	SINAMICS	NRTL listing according to standard UL 508C	U7V 12 06 20078 013 U7 11 04 20078 009 U7 11 04 20078 010 U7 11 04 20078 011
		SIMOTION	NRTL listing according to standard UL 508	U7V 13 03 20078 01
		SIMODRIVE	NRTL listing according to standard UL 508C, CSA C22.2. No. 14	CU 72090702
		Motion Control Encoder	NRTL listing according to UL 61010-1 CSA C22.2 No. 61010-1	U8V 10 06 20196 024

## Certificates of suitability (approvals)

## Overview

Test code	Tested by	Device series/ Component	Test standard	Product category/ File No.
<b>CSA: Canadian Standards Association Independent public testing body in Canada</b>				
	CSA according to CSA standard	SINUMERIK	Standard CSA C22.2 No. 142	2252-01 : LR 102527
<b>FMRC: Factory Mutual Research Corporation Independent public testing body in North America</b>				
	FM according to FM standard	SINUMERIK	Standard FMRC 3600, FMRC 3611, FMRC 3810, ANSI/ISA S82.02.1	–
<b>EAC: Independent public testing body within the Eurasian Conformity Area</b>				
	EAC in accordance with the EAC Directive	SINAMICS SINUMERIK SIMOTION	Standard IEC 61800-5-1/-2, IEC 61800-3	–
<b>RCM: Australian Communications and Media Authority Independent public testing body in Australia</b>				
	RCM according to EMC standard	SINAMICS SINUMERIK SIMOTION	Standard IEC AS 61800-3, EN 61800-3	–
<b>KC: National Radio Research Agency Independent public testing body in South Korea</b>				
	KC according to EMC standard	SINAMICS SINUMERIK SIMOTION	Standard KN 11	–
<b>BIA Federal Institute for Occupational Safety</b>				
–	Functional safety	SINAMICS SINUMERIK SIMOTION	Standard EN 61800-5-2	–
<b>TÜV SÜD Rail</b>				
–	Functional safety	SINAMICS SINUMERIK SIMOTION	Standard EN 61800-5-2	–

More information about certificates can be found online at:  
<https://support.industry.siemens.com/cs/ww/en/ps/cert>

# Selection and ordering at Siemens SiePortal – Ordering products and downloading catalogs

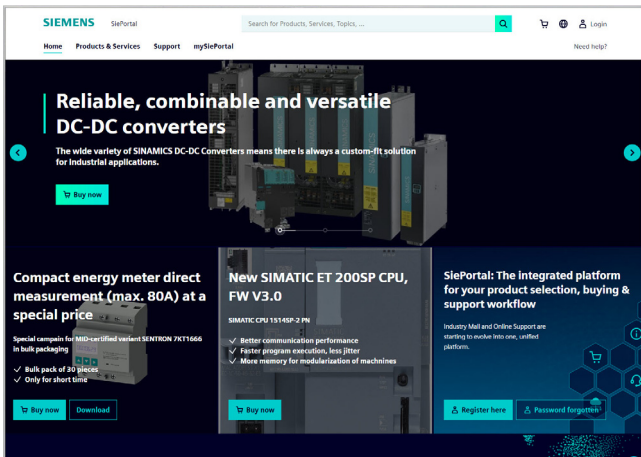

## Easy product selection and ordering with SiePortal

### SiePortal > Products & Services

The internet ordering platform of Siemens AG is located in SiePortal. It provides you with online access to a comprehensive product spectrum that is presented in an informative, well-organized way.

Powerful search functions help you select the required products, while configurators enable you to configure complex product and system components quickly and easily. CAx data are also available for you to use.

Data transfer allows the entire procedure, from selection through ordering to tracking and tracing, to be carried out online. Availability checks, individual customer discounting, and quotation preparation are also possible.

<https://sieportal.siemens.com>

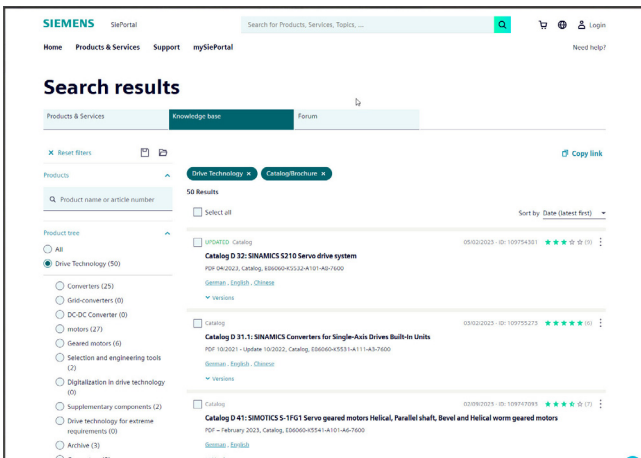

## Downloading catalogs

### SiePortal > Support > Knowledge base

You can download catalogs and brochures in PDF format from Siemens Industry Online Support without having to register.

The filter box makes it possible to perform targeted searches.

<https://sieportal.siemens.com>

## Overview

### **ServicePack**

ServicePacks are used to debug existing products. ServicePacks may be duplicated for use as prescribed according to the number of existing original licenses.

### **License key**

Siemens Digital Industries and Smart Infrastructure supplies software products with and without license keys.

The license key serves as an electronic license stamp and is also the "switch" for activating the software (floating license, rental license, etc.).

The complete installation of software products requiring license keys includes the program to be licensed (the software) and the license key (which represents the license).

### **Software Update Service (SUS)**

As part of the SUS contract, all software updates for the respective product are made available to you free of charge for a period of one year from the invoice date. The contract will automatically be extended for one year if it is not canceled three months before it expires.

The possession of the current version of the respective software is a basic condition for entering into an SUS contract.

You can download explanations concerning license conditions from [https://mall.industry.siemens.com/legal/ww/en/terms\\_of\\_trade\\_en.pdf](https://mall.industry.siemens.com/legal/ww/en/terms_of_trade_en.pdf)



## Appendix

### Conversion tables

**Rotary inertia** (to convert from A to B, multiply by entry in table)

A \ B	lb-in <sup>2</sup>	lb-ft <sup>2</sup>	lb-in-s <sup>2</sup>	lb-ft-s <sup>2</sup> slug-ft <sup>2</sup>	kg-cm <sup>2</sup>	kg-cm-s <sup>2</sup>	gm-cm <sup>2</sup>	gm-cm-s <sup>2</sup>	oz-in <sup>2</sup>	oz-in-s <sup>2</sup>
lb-in <sup>2</sup>	1	$6.94 \times 10^{-3}$	$2.59 \times 10^{-3}$	$2.15 \times 10^{-4}$	2.926	$2.98 \times 10^{-3}$	$2.92 \times 10^3$	2.984	16	$4.14 \times 10^{-2}$
lb-ft <sup>2</sup>	144	1	0.3729	$3.10 \times 10^{-2}$	421.40	0.4297	$4.21 \times 10^5$	429.71	2304	5.967
lb-in-s <sup>2</sup>	386.08	2.681	1	$8.33 \times 10^{-2}$	$1.129 \times 10^3$	1.152	$1.129 \times 10^6$	$1.152 \times 10^3$	$6.177 \times 10^3$	16
lb-ft-s <sup>2</sup> slug-ft <sup>2</sup>	$4.63 \times 10^3$	32.17	12	1	$1.35 \times 10^4$	13.825	$1.355 \times 10^7$	$1.38 \times 10^4$	$7.41 \times 10^4$	192
kg-cm <sup>2</sup>	0.3417	$2.37 \times 10^{-3}$	$8.85 \times 10^{-4}$	$7.37 \times 10^{-5}$	1	$1.019 \times 10^{-3}$	1000	1.019	5.46	$1.41 \times 10^{-2}$
kg-cm-s <sup>2</sup>	335.1	2.327	0.8679	$7.23 \times 10^{-2}$	980.66	1	$9.8 \times 10^5$	1000	$5.36 \times 10^3$	13.887
gm-cm <sup>2</sup>	$3.417 \times 10^{-4}$	$2.37 \times 10^{-6}$	$8.85 \times 10^{-7}$	$7.37 \times 10^{-8}$	$1 \times 10^{-3}$	$1.01 \times 10^{-6}$	1	$1.01 \times 10^{-3}$	$5.46 \times 10^{-3}$	$1.41 \times 10^{-5}$
gm-cm-s <sup>2</sup>	0.335	$2.32 \times 10^{-3}$	$8.67 \times 10^{-4}$	$7.23 \times 10^{-5}$	0.9806	$1 \times 10^{-3}$	980.6	1	5.36	$1.38 \times 10^{-2}$
oz-in <sup>2</sup>	0.0625	$4.34 \times 10^{-4}$	$1.61 \times 10^{-4}$	$1.34 \times 10^{-5}$	0.182	$1.86 \times 10^{-4}$	182.9	0.186	1	$2.59 \times 10^{-3}$
oz-in-s <sup>2</sup>	24.13	0.1675	$6.25 \times 10^{-2}$	$5.20 \times 10^{-3}$	70.615	$7.20 \times 10^{-2}$	$7.09 \times 10^4$	72.0	386.08	1

**Torque** (to convert from A to B, multiply by entry in table)

A \ B	lb-in	lb-ft	oz-in	N-m	kg-cm	kg-m	gm-cm	dyne-cm
lb-in	1	$8.333 \times 10^{-2}$	16	0.113	1.152	$1.152 \times 10^{-2}$	$1.152 \times 10^3$	$1.129 \times 10^6$
lb-ft	12	1	192	1.355	13.825	0.138	$1.382 \times 10^4$	$1.355 \times 10^7$
oz-in	$6.25 \times 10^{-2}$	$5.208 \times 10^{-3}$	1	$7.061 \times 10^{-3}$	$7.200 \times 10^{-2}$	$7.200 \times 10^{-4}$	72.007	$7.061 \times 10^4$
N-m	8.850	0.737	141.612	1	10.197	0.102	$1.019 \times 10^4$	$1 \times 10^7$
kg-cm	0.8679	$7.233 \times 10^{-2}$	13.877	$9.806 \times 10^{-2}$	1	$10^{-2}$	1000	$9.806 \times 10^5$
kg-m	86.796	7.233	$1.388 \times 10^3$	9.806	100	1	$1 \times 10^5$	$9.806 \times 10^7$
gm-cm	$8.679 \times 10^{-4}$	$7.233 \times 10^{-5}$	$1.388 \times 10^{-2}$	$9.806 \times 10^{-5}$	$1 \times 10^{-3}$	$1 \times 10^{-5}$	1	980.665
dyne-cm	$8.850 \times 10^{-7}$	$7.375 \times 10^{-8}$	$1.416 \times 10^{-5}$	$10^{-7}$	$1.0197 \times 10^{-6}$	$1.019 \times 10^{-8}$	$1.019 \times 10^{-3}$	1

**Length** (to convert from A to B, multiply by entry in table)

A \ B	inches	feet	cm	yd	mm	m
inches	1	0.0833	2.54	0.028	25.4	0.0254
feet	12	1	30.48	0.333	304.8	0.3048
cm	0.3937	0.03281	1	$1.09 \times 10^{-2}$	10	0.01
yd	36	3	91.44	1	914.4	0.914
mm	0.03937	0.00328	0.1	$1.09 \times 10^{-3}$	1	0.001
m	39.37	3.281	100	1.09	1000	1

**Force** (to convert from A to B, multiply by entry in table)

A \ B	lb	oz	gm	dyne	N
lb	1	16	453.6	$4.448 \times 10^5$	4.4482
oz	0.0625	1	28.35	$2.780 \times 10^4$	0.27801
gm	$2.205 \times 10^{-3}$	0.03527	1	$1.02 \times 10^{-3}$	N.A.
dyne	$2.248 \times 10^{-6}$	$3.59 \times 10^{-5}$	980.7	1	0.00001
N	0.22481	3.5967	N.A.	100000	1

**Mass** (to convert from A to B, multiply by entry in table)

A \ B	lb	oz	gm	kg	slug
lb	1	16	453.6	0.4536	0.0311
oz	$6.25 \times 10^{-2}$	1	28.35	$0.02835 \times 10^{-3}$	$1.93 \times 10^{-5}$
gm	$2.205 \times 10^{-3}$	$3.527 \times 10^{-2}$	1	$10^{-3}$	$6.852 \times 10^{-5}$
kg	2.205	35.27	$10^3$	1	$6.852 \times 10^{-2}$
slug	32.17	514.8	$1.459 \times 10^4$	14.59	1

**Rotation** (to convert from A to B, multiply by entry in table)

A \ B	rpm	rad/s	degrees/s
rpm	1	0.105	6.0
rad/s	9.55	1	57.30
degrees/s	0.167	$1.745 \times 10^{-2}$	1

**Power** (to convert from A to B, multiply by entry in table)

A \ B	hp	Watts
hp (English)	1	745.7
(lb-in) (deg./s)	$2.645 \times 10^{-6}$	$1.972 \times 10^{-3}$
(lb-in) (rpm)	$1.587 \times 10^{-5}$	$1.183 \times 10^{-2}$
(lb-ft) (deg./s)	$3.173 \times 10^{-5}$	$2.366 \times 10^{-2}$
(lb-ft) (rpm)	$1.904 \times 10^{-4}$	0.1420
Watts	$1.341 \times 10^{-3}$	1

## Conversion tables

## Temperature Conversion

°F	°C	°C	°F
0	-17.8	-10	14
32	0	0	32
50	10	10	50
70	21.1	20	68
90	32.2	30	86
98.4	37	37	98.4
212	100	100	212
subtract 32 and multiply by $\frac{5}{9}$		multiply by $\frac{9}{5}$ and add 32	

## Mechanism Efficiencies

Acme-screw with brass nut	~0.35–0.65
Acme-screw with plastic nut	~0.50–0.85
Ball-screw	~0.85–0.95
Chain and sprocket	~0.95–0.98
Preloaded ball-screw	~0.75–0.85
Spur or bevel-gears	~0.90
Timing belts	~0.96–0.98
Worm gears	~0.45–0.85
Helical gear (1 reduction)	~0.92

## Friction Coefficients

Materials	$\mu$
Steel on steel (greased)	~0.15
Plastic on steel	~0.15–0.25
Copper on steel	~0.30
Brass on steel	~0.35
Aluminum on steel	~0.45
Steel on steel	~0.58
Mechanism	$\mu$
Ball bushings	<0.001
Linear bearings	<0.001
Dove-tail slides	~0.2++
Gibb ways	~0.5++

## Material Densities

Material	lb-in <sup>3</sup>	gm-cm <sup>3</sup>
Aluminum	0.096	2.66
Brass	0.299	8.30
Bronze	0.295	8.17
Copper	0.322	8.91
Hard wood	0.029	0.80
Soft wood	0.018	0.48
Plastic	0.040	1.11
Glass	0.079–0.090	2.2–2.5
Titanium	0.163	4.51
Paper	0.025–0.043	0.7–1.2
Polyvinyl chloride	0.047–0.050	1.3–1.4
Rubber	0.033–0.036	0.92–0.99
Silicone rubber, without filler	0.043	1.2
Cast iron, gray	0.274	7.6
Steel	0.280	7.75

Wire Gauges<sup>1)</sup>

Cross-section mm <sup>2</sup>	Standard Wire Gauge (SWG)	American Wire Gauge (AWG)
0.2	25	24
0.3	23	22
0.5	21	20
0.75	20	19
1.0	19	18
1.5	17	16
2.5	15	13
4	13	11
6	12	9
10	9	7
16	7	6
25	5	3
35	3	2
50	0	1/0
70	000	2/0
95	00000	3/0
120	0000000	4/0
150	–	6/0
185	–	7/0

<sup>1)</sup> The table shows approximate SWG/AWG sizes nearest to standard metric sizes; the cross-sections do not match exactly.

## Appendix

### Metal surcharges

#### Explanation of the raw material/metal surcharges<sup>1)</sup>

##### Surcharge calculation

To compensate for variations in the price of the raw materials silver, copper, aluminum, lead, gold, dysprosium<sup>2)</sup> and/or neodym<sup>2)</sup>, surcharges are calculated on a daily basis using the so-called metal factor. These apply to products containing these raw materials and are calculated per raw material. These surcharges are added to the price of a product if the basic official price (BOP) of the raw material in question is exceeded. Surcharges are calculated in accordance with the following criteria:

##### Basic official price (BOP) of the raw material

- BOP of the workday prior to receipt of the order or prior to release order (Daily Price) for:
  - Silver (processed)<sup>3)</sup>
  - Gold (processed)<sup>3)</sup>
  - Aluminum (temporary constant 360.31 EUR per 100 kg, due to loss of DEL-Notiz)
  - Lead (constant 199.50 EUR per 100 kg)
- BOP of two workdays prior to receipt of the order or prior to release order (Daily Price) per 100 kg for:
  - Copper (LME-notation/10, converted from USD to EUR using LME-FX-Rate [MTLE] + 1.2 %) + 1 %<sup>4)</sup>
- If BOP is suspended, the last one is used.

##### Metal factor of the products

Certain products are displayed with a metal factor. The metal factor determines the official price (for those raw materials concerned) as of which the metal surcharges are applied and the calculation method used (weight or percentage method). An exact explanation is given below.

##### Structure of the metal factor

Metal factor consists of several digits; the first digit indicates whether the percentage method of calculation refers to the list price or a discounted price (customer net price) (L = list price / N = customer net price).

The remaining digits indicate the method of calculation used for the respective raw material. If no surcharge is added for a raw material, a "-" is used.

1st digit	List or customer net price using the percentage method
2nd digit	for silver (AG)
3rd digit	for copper (CU)
4th digit	for aluminum (AL)
5th digit	for lead (PB)
6th digit	for gold (AU)
7th digit	for dysprosium (Dy) <sup>2)</sup>
8th digit	for neodym (Nd) <sup>2)</sup>

##### Weight method

The weight method uses the BOP, the daily price and the raw material weight. In order to calculate the surcharge, the BOP must be subtracted from the daily price. The difference is then multiplied by the raw material weight.

The BOP can be found in the table below using the number (1 to 9) of the respective digit of the metal factor. The raw material weight can be found in the respective product descriptions.

##### Percentage method

Use of the percentage method is indicated by the letters A-Z at the respective digit of the metal factor.

The surcharge is increased - dependent on the deviation of the daily price compared with the BOP - using the percentage method in "steps" and consequently offers surcharges that remain constant within the framework of this "step range". A higher percentage rate is charged for each new step. The respective percentage level can be found in the table below.

##### Metal factor examples

<b>L E A - - - - -</b>	<p>Basis for % surcharge: List price</p> <p>Silver Basis 150 €, Step 50 €, 0.5 %</p> <p>Copper Basis 150 €, Step 50 €, 0.1 %</p> <p>No surcharge for aluminum</p> <p>No surcharge for lead</p> <p>No surcharge for gold</p> <p>No surcharge for dysprosium</p> <p>No surcharge for neodym</p>
<b>N - A 6 - - - - -</b>	<p>Basis for % surcharge: Customer net price</p> <p>No surcharge for silver</p> <p>Copper Basis 150 €, Step 50 €, 0.1 %</p> <p>Aluminum acc. to weight, basic offic. price 225 €</p> <p>No surcharge for lead</p> <p>No surcharge for gold</p> <p>No surcharge for dysprosium</p> <p>No surcharge for neodym</p>
<b>- - 3 - - - - -</b>	<p>No basis necessary</p> <p>No surcharge for silver</p> <p>Copper acc. to weight, basic official price 150 €</p> <p>No surcharge for aluminum</p> <p>No surcharge for lead</p> <p>No surcharge for gold</p> <p>No surcharge for dysprosium</p> <p>No surcharge for neodym</p>

1) Refer to the separate explanation on the next page regarding the raw materials dysprosium and neodym (= rare earths).

2) For a different method of calculation, refer to the separate explanation for these raw materials on the next page.

3) Source: Umicore, Hanau ([www.metalsmanagement.umicore.com](http://www.metalsmanagement.umicore.com)).

4) Source: The London Metal Exchange – an HKEX Company (<https://www.lme.com/>).

Siemens uses LME's data and trademarks within the scope of a license granted by LME, LME has no involvement and accepts no responsibility to any third party in connection with the use of data and trademarks, onward distribution of data and trademarks by third parties is not permitted.

## Explanation of the raw material/metal surcharges for dysprosium and neodym (rare earths)

### Surcharge calculation

To compensate for variations in the price of the raw materials silver<sup>1)</sup>, copper<sup>1)</sup>, aluminum<sup>1)</sup>, lead<sup>1)</sup>, gold<sup>1)</sup>, dysprosium and/or neodym, surcharges are calculated on a daily basis using the so-called metal factor. This applies to products containing at least one of these raw materials. The surcharge for dysprosium and neodym is calculated as a supplement to the price of a product if the basic official price (BOP) of the raw material in question is exceeded.

The surcharge is calculated in accordance with the following criteria:

- Basic official price (BOP) of the raw material<sup>2)</sup>  
Three-month basic average price (see below) in the period before the quarter in which the order was received or the release order took place (average official price) for
  - Dysprosium (Dy metal, 99 % min. FOB China; USD/kg)
  - Neodym (Nd metal, 99 % min. FOB China; USD/kg)
- Metal factor of the products  
Certain products are displayed with a metal factor. The metal factor indicates (for those raw materials concerned) the BOP as of which the surcharges for dysprosium and neodym are calculated using the weight method. An exact explanation of the metal factor is given below.

### Three-month average price

The prices of rare earths vary according to the foreign currency, and there is no freely accessible stock exchange listing. This makes it more difficult for all parties involved to monitor changes in price. In order to avoid continuous adjustment of the surcharges, but to still ensure fair, transparent pricing, an average price is calculated over a three-month period using the average monthly foreign exchange rate from USD to EUR (source: European Central Bank). Since not all facts are immediately available at the start of each month, a one-month buffer is allowed before the new average price applies.

Examples of calculation of the average official price:

Period for calculation of the average price:	Period during which the order/release order is effected and the average price applies:
Sep 2012 - Nov 2012	Q1 in 2013 (Jan - Mar)
Dec 2012 - Feb 2013	Q2 in 2013 (Apr - Jun)
Mar 2013 - May 2013	Q3 in 2013 (Jul - Sep)
Jun 2013 - Aug 2013	Q4 in 2013 (Oct - Dec)

### Structure of the metal factor

The metal factor consists of several digits; the first digit is not relevant to the calculation of dysprosium and neodym.

The remaining digits indicate the method of calculation used for the respective raw material. If no surcharge is added for a raw material, a "-" is used.

1st digit	List or customer net price using the percentage method
2nd digit	for silver (AG) <sup>1)</sup>
3rd digit	for copper (CU) <sup>1)</sup>
4th digit	for aluminum (AL) <sup>1)</sup>
5th digit	for lead (PB) <sup>1)</sup>
6th digit	for gold (AU) <sup>1)</sup>
7th digit	for dysprosium (Dy)
8th digit	for neodym (Nd)

### Weight method

The weight method uses the basic official price, the average price and the raw material weight. In order to calculate the surcharge, the BOP must be subtracted from the average price. The difference is then multiplied by the raw material weight.

The basic official price can be found in the table below using the number (1 to 9) of the respective digit of the metal factor. Your Sales contact can inform you of the raw material weight.

### Metal factor examples

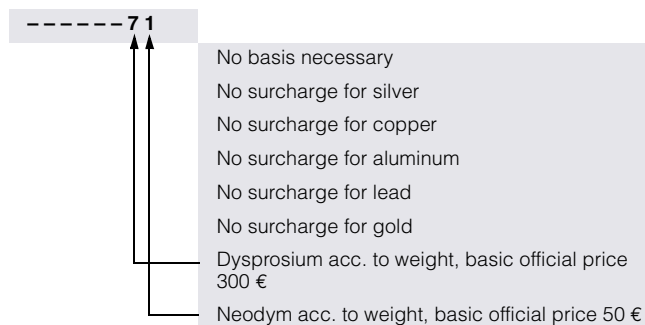

1) For a different method of calculation, refer to the separate explanation for these raw materials on the previous page.

2) Source: Asian Metal Ltd ([www.asianmetal.com](http://www.asianmetal.com))

## Appendix

### Metal surcharges

#### Values of the metal factor

Percentage method	Basic official price in €	Step range in €	% surcharge 1st step	% surcharge 2nd step	% surcharge 3rd step	% surcharge 4th step	% surcharge per additional step
			Price in €	Price in €	Price in €	Price in €	
			150.01 - 200.00	200.01 - 250.00	250.01 - 300.00	300.01 - 350.00	
A	150	50	0.1	0.2	0.3	0.4	0.1
B	150	50	0.2	0.4	0.6	0.8	0.2
C	150	50	0.3	0.6	0.9	1.2	0.3
D	150	50	0.4	0.8	1.2	1.6	0.4
E	150	50	0.5	1.0	1.5	2.0	0.5
F	150	50	0.6	1.2	1.8	2.4	0.6
G	150	50	1.0	2.0	3.0	4.0	1.0
H	150	50	1.2	2.4	3.6	4.8	1.2
I	150	50	1.6	3.2	4.8	6.4	1.6
J	150	50	1.8	3.6	5.4	7.2	1.8
			175.01 - 225.00	225.01 - 275.00	275.01 - 325.00	325.01 - 375.00	
O	175	50	0.1	0.2	0.3	0.4	0.1
P	175	50	0.2	0.4	0.6	0.8	0.2
R	175	50	0.5	1.0	1.5	2.0	0.5
			225.01 - 275.00	275.01 - 325.00	325.01 - 375.00	375.01 - 425.00	
S	225	50	0.2	0.4	0.6	0.8	0.2
U	225	50	1.0	2.0	3.0	4.0	1.0
V	225	50	1.0	1.5	2.0	3.0	1.0
W	225	50	1.2	2.5	3.5	4.5	1.0
			150.01 - 175.00	175.01 - 200.00	200.01 - 225.00	225.01 - 250.00	
Y	150	25	0.3	0.6	0.9	1.2	0.3
			400.01 - 425.00	425.01 - 450.00	450.01 - 475.00	475.01 - 500.00	
Z	400	25	0.1	0.2	0.3	0.4	0.1
<b>Price basis (1st digit)</b>							
L	Calculation based on the list price						
N	Calculation based on the customer net price (discounted list price)						
<b>Weight method</b>	<b>Basic official price in €</b>						
1	50	Calculation based on raw material weight					
2	100						
3	150						
4	175						
5	200						
6	225						
7	300						
8	400						
9	555						
<b>Miscellaneous</b>							
-	No metal surcharge						

### 1. General Provisions

By using this catalog you can purchase hard- and software products as well as services (together hereinafter referred to as "products") described therein from Siemens Aktiengesellschaft subject to the following Terms and Conditions of Sale and Delivery (hereinafter referred to as "T&C"). Note, for products purchased from any Siemens entity having a registered office outside of Germany, the respective terms and conditions of sale and delivery of the respective Siemens entity apply exclusively. The following T&C apply exclusively for orders placed with Siemens Aktiengesellschaft, Germany.

#### 1.1 For customers with a seat or registered office in European Union

For customers with a seat or registered office in European Union, the following terms and conditions apply subordinate to T&C:

- for products, which include specific terms and conditions in the text of the product description, these specific terms and conditions shall apply and subordinate thereto,.
- for stand-alone software products and software products forming a part of a product or project, the "General Conditions for Software Products for Infrastructure & Industry Business (German law)"<sup>1)</sup> and/or
- for consulting services the "Allgemeine Geschäftsbedingungen für Beratungsleistungen für Infrastructure & Industry Geschäft (Deutsches Recht)"<sup>1)</sup> (available only in German) and/or
- for other services, the „Supplementary Terms and Conditions for Services for Infrastructure & Industry Business (German Law) ("BL")"<sup>1)</sup> and/or
- for other products the "General Conditions for the Supply of Products and Services of the Electrical and Electronics Industry"<sup>1)</sup>.  
In case such products should contain Open Source Software, the conditions of which shall prevail over the "General Conditions for the Supply of Products and Services of the Electrical and Electronics Industry"<sup>1)</sup>, the Product will be given a note as to which special conditions apply to this open source software. This shall apply mutatis mutandis for notices referring to other third-party software components.

#### 1.2 For customers with a seat or registered office outside European Union

For customers with a seat or registered office outside European Union, the following terms and conditions apply subordinate to T&C:

- for products, which include specific terms and conditions in the description text, these specific terms and conditions shall apply and subordinate thereto,
- for consulting services the "Standard Terms and Conditions for Consulting Services for Infrastructure & Industry Business (Swiss Law)"<sup>1)</sup> and/or
- for other services the "International Terms & Conditions for Services"<sup>1)</sup> supplemented by "Software Licensing Conditions"<sup>1)</sup> and/or
- for other products the "International Terms & Conditions for Products"<sup>1)</sup> supplemented by "Software Licensing Conditions"<sup>1)</sup>

#### 1.3 For customers with master or framework agreement

To the extent products offered are covered by an existing master or framework agreement, the terms and conditions of that agreement shall apply instead of T&C.

### 2. Prices

The prices are in € (Euro) ex point of delivery, exclusive of packaging.

The sales tax (value added tax) is not included in the prices. It shall be charged separately at the respective rate according to the applicable statutory legal regulations.

Prices are subject to change without prior notice. We will charge the prices valid at the time of delivery.

To compensate for variations in the price of raw materials (e.g. silver, copper, aluminum, lead, gold, dysprosium and neodym), surcharges are calculated on a daily basis using the so-called metal factor for products containing these raw materials.

A surcharge for the respective raw material is calculated as a supplement to the price of a product if the basic official price of the raw material in question is exceeded.

The metal factor of a product indicates the basic official price (for those raw materials concerned) as of which the surcharges on the price of the product are applied, and with what method of calculation. The metal factor, provided it is relevant, can be found in the respective product description.

You will find a detailed explanation of the metal factor on the page headed "Metal surcharges".

To calculate the surcharge (except in the cases of copper, dysprosium and neodym), the official price from the day prior to that on which the order was received or the release order was effected is used.

To calculate the surcharge applicable to copper, the official price from two days prior to that on which the order was received or the release order was effected is used.

To calculate the surcharge applicable to dysprosium and neodym ("rare earths"), the corresponding three-month basic average price in the quarter prior to that in which the order was received or the release order was effected is used with a one-month buffer (details on the calculation can be found in the explanation of the metal factor).

### 3. Additional Terms and Conditions

The dimensions are in mm. In Germany, according to the German law on units in measuring technology, data in inches apply only to devices for export.

Illustrations are not binding.

Insofar as there are no remarks on the individual pages of this catalog – especially with regard to data, dimensions and weights given – these are subject to change without prior notice.

<sup>1)</sup> The text of the Terms and Conditions of Siemens AG can be downloaded at  
[https://mall.industry.siemens.com/legal/ww/en/terms\\_of\\_trade\\_en.pdf](https://mall.industry.siemens.com/legal/ww/en/terms_of_trade_en.pdf)



## Appendix

### Conditions of sale and delivery

#### 4. Export Control and Sanctions Compliance

##### 4.1 General

Customer shall comply with all applicable sanctions, embargoes and (re-)export control laws and regulations, and, in any event, with those of the European Union, the United States of America and any locally applicable jurisdiction (collectively "Export Regulations").

##### 4.2 Checks for Products

Prior to any transaction by customer concerning products (including hardware, documentation and technology) delivered by Siemens, or products (including maintenance and technical support) performed by Siemens with a third party, customer shall check and certify by appropriate measures that

- (i) the customer's use, transfer, or distribution of such products, the brokering of contracts or the provision of other economic resources in connection with products will not be in violation of any Export Regulations, also taking into account any prohibitions to circumvent these (e.g., by undue diversion)
- (ii) the products are not intended or provided for prohibited or unauthorized non-civilian purposes (e.g. armaments, nuclear technology, weapons, or any other usage in the field of defense and military);
- (iii) customer has screened all direct and indirect parties involved in the receipt, use, transfer, or distribution of the products against all applicable restricted party lists of the Export Regulations concerning trading with entities, persons and organizations listed therein and
- (iv) products within the scope of items-related restrictions, as specified in the respective annexes to the Export Regulations, will not, unless permitted by the Export Regulations, be
  - (a) exported, directly or indirectly (e.g., via Eurasian Economic Union (EAEU) countries), to Russia or Belarus, or
  - (b) resold to any third party business partner that does not take a prior commitment not to export such products to Russia or Belarus.

##### 4.3 Non-Acceptable Use of Software and Cloud Services

Customer shall not, unless permitted by the Export Regulations or respective governmental licenses or approvals,

- (i) download, install, access or use the products from or in any location prohibited by or subject to comprehensive sanctions or subject or to license requirements according to the Export Regulations;
  - (ii) grant access to, transfer, (re-)export (including any "deemed (re-)exports"), or otherwise make available the products to any entity, person, or organization identified on a restricted party list of the Export Regulations;
  - (iii) use the products for any purpose prohibited by the Export Regulations (e.g. use in connection with armaments, nuclear technology or weapons);
  - (iv) upload to a products platform any customer content unless it is non-controlled (e.g. in the EU: AL = N; in the U.S.: ECCN = N or EAR99);
  - (v) facilitate any of the afore mentioned activities by any user.
- Customer shall provide all users with all information necessary to ensure compliance with the Export Regulations.

#### 4.4 Semiconductor Development

Customer will not, without advance written authorization from Siemens, use offerings for the development or production of integrated circuits at any semiconductor fabrication facility located in China meeting the criteria specified in the U.S. Export Administration Regulations, 15 C.F.R. 744.23.

##### 4.5 Information

Upon request by Siemens, customer shall promptly provide Siemens with all information pertaining to users, the intended use and the location of use or the final destination (in the case of hardware, documentation and technology) of the products. Customer will notify Siemens prior to customer disclosing any information to Siemens that is defense-related or requires controlled or special data handling pursuant to applicable government regulations, and will use the disclosure tools and methods specified by Siemens.

##### 4.6 Reservation

Siemens shall not be obligated to fulfill this agreement if such fulfillment is prevented by any impediments arising out of national or international foreign trade or customs requirements or any embargoes or other sanctions. Customer acknowledges that Siemens may be obliged under the Export Regulations to limit or suspend access by customer and/or users to products.

#### 5. Miscellaneous

Errors excepted and subject to change without prior notice.

# Selection and ordering at Siemens SiePortal – Ordering products and downloading catalogs

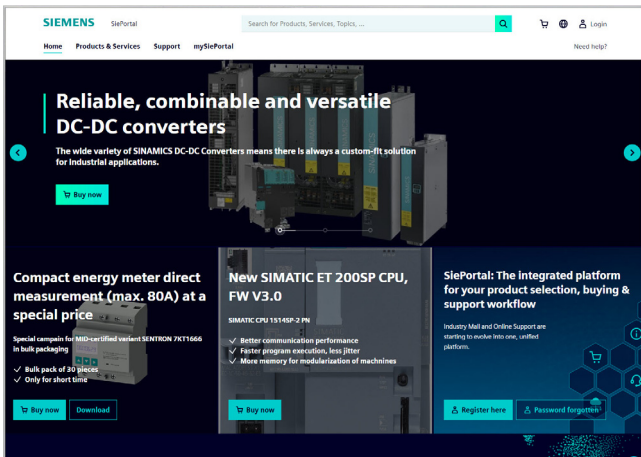

## Easy product selection and ordering with SiePortal

### SiePortal > Products & Services

The internet ordering platform of Siemens AG is located in SiePortal. It provides you with online access to a comprehensive product spectrum that is presented in an informative, well-organized way.

Powerful search functions help you select the required products, while configurators enable you to configure complex product and system components quickly and easily. CAx data are also available for you to use.

Data transfer allows the entire procedure, from selection through ordering to tracking and tracing, to be carried out online. Availability checks, individual customer discounting, and quotation preparation are also possible.

<https://sieportal.siemens.com>

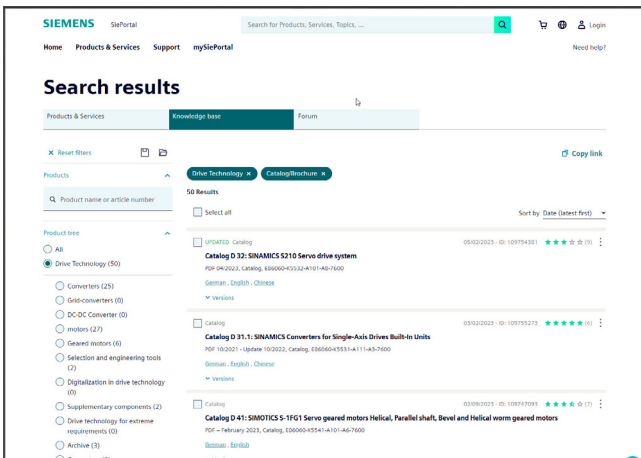

## Downloading catalogs

### SiePortal > Support > Knowledge base

You can download catalogs and brochures in PDF format from Siemens Industry Online Support without having to register.

The filter box makes it possible to perform targeted searches.

<https://sieportal.siemens.com>

## Cybersecurity information

Siemens provides products and solutions with industrial security functions that support the secure operation of plants, systems, machines and networks.

In order to protect plants, systems, machines and networks against cyber threats, it is necessary to implement – and continuously maintain – a holistic, state-of-the-art industrial cybersecurity concept. Siemens' products and solutions constitute one element of such a concept.

Customers are responsible for preventing unauthorized access to their plants, systems, machines and networks. Such systems, machines and components should only be connected to an enterprise network or the internet if and to the extent such a connection is necessary and only when appropriate security measures (e.g. firewalls and/or network segmentation) are in place.

For additional information on industrial cybersecurity measures that may be implemented, please visit

[www.siemens.com/cybersecurity-industry](http://www.siemens.com/cybersecurity-industry)

Siemens' products and solutions undergo continuous development to make them more secure. Siemens strongly recommends that product updates are applied as soon as they are available and that the latest product versions are used. Use of product versions that are no longer supported, and failure to apply the latest updates may increase customer's exposure to cyber threats.

To stay informed about product updates, subscribe to the Siemens Industrial Security RSS Feed under [www.siemens.com/cert](http://www.siemens.com/cert)

## Get more information

SINAMICS G120X infrastructure converters for HVAC/Water/Wastewater:

[www.siemens.com/sinamics-g120x](http://www.siemens.com/sinamics-g120x)

SIMOTICS motors for industry:

[www.siemens.com/simotics](http://www.siemens.com/simotics)

Motion Control Systems and Solutions for production machine and machine tool equipment:

[www.siemens.com/motioncontrol](http://www.siemens.com/motioncontrol)

Local partners worldwide:

[www.siemens.com/automation-contact](http://www.siemens.com/automation-contact)

Published by  
Siemens AG

Digital Industries  
Motion Control  
Postfach 31 80  
91050 Erlangen, Germany

For the U.S. published by  
Siemens Industry Inc.

100 Technology Drive  
Alpharetta, GA 30005  
United States

PDF (Article No. E86060-K5531-A151-A5-7600)  
V6.MKKATA.GMC.106  
KG 0724 128 En  
Produced in Germany  
© Siemens 2024

Subject to changes and errors. The information given in this document only contains general descriptions and/or performance features which may not always specifically reflect those described, or which may undergo modification in the course of further development of the products. The requested performance features are binding only when they are expressly agreed upon in the concluded contract.

All product designations may be trademarks or product names of Siemens AG or other companies whose use by third parties for their own purposes could violate the rights of the owners.