

MOTION CONTROL DRIVES

## SINAMICS Converters for Single-Axis Drives

### SINAMICS G220

Built-in and wall-mounted units

[siemens.com/d36-1](https://www.siemens.com/d36-1)

















Catalog  
D 36.1

Edition  
January  
2025

Next  
Generation



## Related catalogs

<p><b>Motion Control Drives</b> D 31.1 SINAMICS Inverters for Single-Axis Drives Built-In Units</p> <p>PDF (E86060-K5531-A111-A4-7600)</p>		<p><b>SIMOTICS S-1FG1</b> D 41 <b>Servo geared motors</b> Helical, Parallel shaft, Bevel and Helical worm geared motors</p> <p>PDF (E86060-K5541-A101-A6-7600)</p>	
<p><b>Motion Control Drives</b> D 31.2 SINAMICS Converters for Single-Axis Drives Distributed Converters</p> <p>PDF (E86060-K5531-A121-A4-7600)</p>		<p><b>Motion Control System</b> PM 21 <b>SIMOTION</b> Equipment for Production Machines</p> <p>E86060-K4921-A101-A4-7600</p>	
<p><b>Motion Control Drives</b> D 31.5 SINAMICS Converters for Single-Axis Drives SINAMICS G120X infrastructure converters for HVAC/Water/Wastewater</p> <p>PDF (E86060-K5531-A151-A5-7600)</p>		<p><b>Industrial Controls</b> IC 10 <b>SIRIUS</b></p> <p>PDF (E86060-K1010-A101-B7-7600)</p>	
<p><b>Motion Control Drives</b> D 32 SINAMICS S210 Servo Drive System</p> <p>PDF (E86060-K5532-A101-A9-7600)</p>		<p><b>Low-Voltage Power Distribution and Electrical Installation Technology</b> LV 10 <b>SENTRON • SIVACON • ALPHA</b></p> <p>PDF (E86060-K8280-A101-B9-7600)</p>	
<p><b>Motion Control Drives</b> D 34 SIMATIC MICRO-DRIVE Servo Drive System</p> <p>PDF (E86060-K5534-A101-A3-7600)</p>		<p><b>SIMATIC</b> ST 70 Products for Totally Integrated Automation</p> <p>PDF (E86060-K4670-A101-C1-7600)</p>	
<p><b>Motion Control Drives</b> D 37.1 SINAMICS S200 Servo drive system</p> <p>PDF (E86060-K5537-A111-A2-7600)</p>		<p><b>SIMATIC HMI / PC-based Automation</b> ST 80/ST PC Human Machine Interface Systems PC-based Automation</p> <p>PDF (E86060-K4680-A101-D2-7600)</p>	
<p><b>SINAMICS S120</b> D 21.3 Chassis Format Converter Units Chassis-2 Format Converter Units Cabinet Modules, Cabinet Modules-2 <b>SINAMICS S150</b> Converter Cabinet Units PDF (E86060-K5521-A131-A9-7600)</p>		<p><b>SITRAIN</b> Digital Industry Academy</p> <p><a href="http://www.siemens.com/sitrain">www.siemens.com/sitrain</a></p>	
<p><b>Motion Control Drives</b> D 21.4 SINAMICS S120, SINAMICS S220 and SIMOTICS</p> <p>PDF (E86060-K5521-A141-A2-7600)</p>		<p><b>SiePortal</b> Information and Ordering Platform on the Internet</p> <p><a href="http://sieportal.siemens.com">sieportal.siemens.com</a></p>	
<p><b>SINAMICS DCM</b> D 23.1 DC Converter, Control Module</p> <p>E86060-K5523-A111-A3-7600</p>			

Catalog  
D 36.1

Edition  
January  
2025

Next  
Generation



Combining the real and digital worlds ...  
Transformation

## MOTION CONTROL DRIVES

# SINAMICS Converters for Single-Axis Drives

## SINAMICS G220

### Built-in and wall-mounted units

[siemens.com/d36-1](https://www.siemens.com/d36-1)

Dear Customer,

We are happy to present you with the new PDF version of the Catalog D 36.1 · January 2025.

The catalog provides a comprehensive overview of the SINAMICS G220 built-in and wall-mounted units including the innovative SINAMICS G220 Clean Power to reduce effectively line harmonics. The new SINAMICS G220 is an efficient, secure and future-proof converter system that has been specifically developed for high-performance applications in manufacturing, process industries and marine infrastructure.

The products listed in this Catalog are also included in SiePortal.  
Please contact your local Siemens office for additional information.

Up-to-date information about SINAMICS G220 is available online at [www.siemens.com/sinamics-g220](https://www.siemens.com/sinamics-g220)

You can access SiePortal on the internet at <https://sieportal.siemens.com>

Your personal contact will be glad to receive your suggestions and recommendations for improvement. You can find your representative in our personal contacts database at [www.siemens.com/automation-contact](https://www.siemens.com/automation-contact)

We hope that you will often enjoy using the new Catalog D 36.1 · January 2025 as a selection and ordering reference document and wish you every success with our products and solutions.

With kind regards

Frank Golüke  
Vice President  
General Motion Control  
Siemens AG, Digital Industries, Motion Control







# SINAMICS Converters for Single-Axis Drives

## SINAMICS G220 built-in and wall-mounted units

### Motion Control Drives



Catalog D 36.1 · January 2025

Supersedes:  
Catalog D 36.1 · June 2024

Refer to SiePortal for current updates of this catalog:  
<https://sieportal.siemens.com>

Please contact your local Siemens branch.

© Siemens 2025

Click on an Article No. in the catalog PDF to call it up in SiePortal and to obtain all the information.

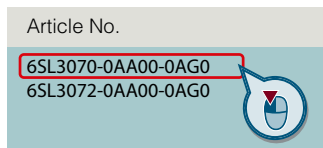

Or directly on the internet, e.g.  
[www.siemens.com/product\\_catalog\\_DIMC?6SL3070-0AA00-0AGO](http://www.siemens.com/product_catalog_DIMC?6SL3070-0AA00-0AGO)



The products and systems described in this catalog are manufactured/distributed under application of a certified quality management system in accordance with EN ISO 9001. The certificate is recognized by all IQNet countries.

### System overview

1

### SINAMICS G220 built-in and wall-mounted units

2

### Engineering tools

3

### Services and documentation

4

### Appendix

5



# Motion beyond expectations

Drives move the industries. But how can they make them more efficient, more reliable and more sustainable – and exceed all expectations while they are doing it? Our answer: Siemens Xcelerator for Digital Drivetrain.

## Digital solutions for Drivetrain Design and Drivetrain Health

Combine the real and the digital world to reach the next level of efficiency and sustainability in your drivetrain value chain: with suitable digital solutions for drivetrain design and drivetrain health.

### Drivetrain Design:

Simplify and shorten the engineering steps to get faster and more efficiently from concept to the commissioned drivetrain.

### Drivetrain Health:

Reduce total cost of ownership for your equipment and machine park – energy, maintenance, downtime.

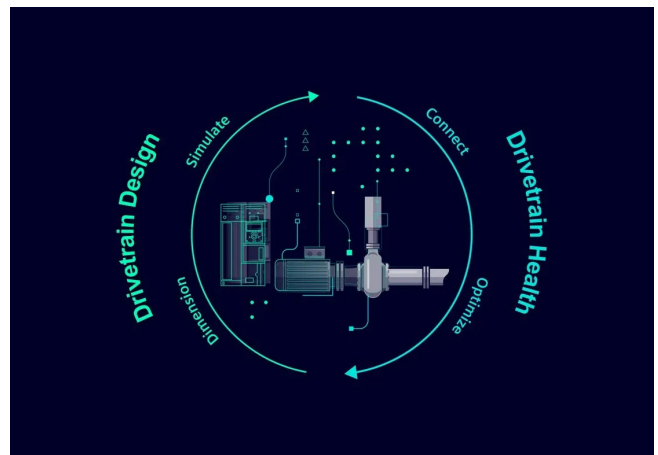

[siemens.com/digital-drivetrain](https://www.siemens.com/digital-drivetrain)

## Digitalization along the drivetrain value chain



### Dimension

Accurate in motion: Dimension your motors, gearboxes, and complete drivetrains digitally with greater precision – for greater reliability and energy efficiency.



### Simulate

Faster in motion: Add the digital twin of the drivetrain to your machine simulation to speed up your design and engineering phases and to accelerate your time-to-market!

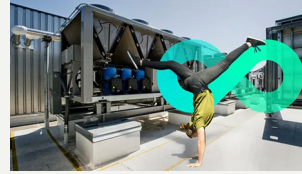

### Connect

Data in motion: Acquire high-quality raw data and connect your entire drivetrains or machines to cloud or on-premise platforms – for a consistent and secure data flow.



### Optimize

Better in motion: Analyze and visualize drivetrain and machine data in digital solutions and apps to identify optimization potentials and concrete actionable measures how to tap it.

## Use cases for digital drivetrain technology



### Condition monitoring for drivetrains

Healthy in motion: Gain valuable insights into your drivetrain to optimize maintenance, system availability, cost efficiency, and sustainability: Discover intelligent digital condition monitoring for your drivetrains!

## Are your drivetrains fit enough for tough times?

The industries are expected to produce ever more efficiently, ever more sustainably and ever more cost-effectively. And if you can't do that, it's easier to be left behind by the competition. Use digitalization and the data from your motors and converters to optimize your competitiveness – and to keep your production in motion.



### What if you consume too much electricity?

With digital solutions and digital drive technology, you can significantly reduce your share of this!



### What if you waste too much energy?

Digitalization enables you to detect energy waste and impending system downtimes at an early stage so that you can take counter-measures in due time!



### What if your motors are incorrectly designed?

Digital tools make it quicker and easier to correctly design your drive components!



### What if your drives fail unexpectedly?

With digital solutions, you can identify risks in your drivetrain at an early stage and react before a failure occurs.

"Our digital solutions transform your drivetrain value chain to the next level of efficiency and sustainability."





# SINAMICS frequency converters

SINAMICS frequency converters – the ultimate solution for all drive applications. From low voltage to medium voltage to direct current (DC), our frequency converters meet your needs. With increased efficiency and versatility, take your applications to the next generation for a digital and sustainable future.

## Driving next generation applications

When it comes to driving industry advancements, look no further than our SINAMICS frequency converters. They fuel the creation of innovative, next-generation applications that meet the unique needs of every industry.

From pumping and ventilating to moving, positioning, processing, and machining, our converters have you covered. Get ready to take your applications to new heights.



### Low voltage converters

Low voltage frequency converters are suitable for a huge range of applications. For example, if materials must be moved, processed, positioned, pumped or compressed. Variable-speed operation saves energy and also increases process quality and process availability.



### Servo converters

These servo converters meet the highest dynamic requirements for single and multi-axis applications. The perfect solution for machine tools, packaging machines, continuous material handling, cranes, rolling mills, test stands, material handling, robotics and many other applications requiring high-precision, dynamic motion control.



### DC converters

The dynamic performance, ruggedness, and cost-effectiveness of DC technology continue to make it the most cost-effective and proven drive solution for many applications today – with numerous advantages in terms of reliability, ease of use, and operational performance.



### Accelerating the digital and sustainable transformation of industry

How can you make production more efficient? Accelerate your digital transformation? And become more sustainable?

The answer is our SINAMICS frequency converters. They are energy efficient, offer the versatility you need for any application, and drive your digital transformation by providing the data to continuously improve production efficiency and sustainability. Our converters offer you integrated safety and security features, efficient engineering and software tools as well as comprehensive lifecycle services. In other words: Everything you need to address the next generation of applications – today and tomorrow.

## EFFICIENT

Implement energy-efficient applications easily, quickly, and safely with efficient motion control.

- Sustainable drive systems
- Efficient Motion Control solutions
- Drive System Services

## VERSATILE

Drives equipped with tailored safety features to ensure optimal machine safety in a wide range of industrial applications.

- Safety and Security Integrated
- Drive applications
- Drives for any industry

## FUTURE-PROOF

Efficient engineering, powerful software tools, and cloud and edge connectivity for greater transparency.

- Digitalization in drive technology
- Efficient drive engineering
- Drive Software for all applications

# Totally Integrated Automation



Totally Integrated Automation (TIA) offers smart automation development, flexible machine concepts, transparent operation, and sustainable solutions that enable access to data to calculate and optimize the product carbon footprint. We are constantly improving and expanding TIA to be future-proof and adaptive to existing and upcoming challenges.

## A comprehensive portfolio for the challenges of today and tomorrow

The TIA offering is integrated seamlessly and it's so comprehensive that it provides the right automation solutions for every industry. We will continue to improve and expand our proven automation portfolio and are constantly including innovative technologies and solutions that pave the way towards the factory of the future.

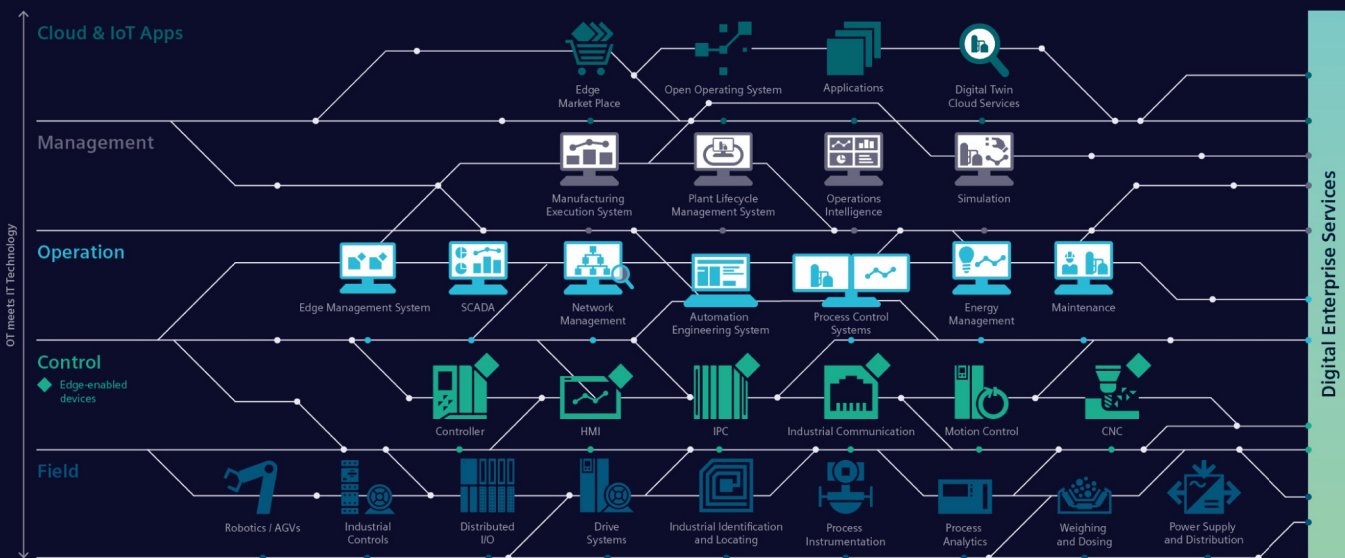



# Real added value for the automation of your production

From the development of innovative machine concepts to engineering and optimized production:

TIA offers real added value along the entire value chain.

## Smart Automation Development

Innovative machine concepts made easy: When you use standardized library concepts and preconfigured expertise, you can count on efficient engineering. Thanks to the integration of safety features, diagnostic functions, and cybersecurity, you also save valuable time.

## Flexible Machine Concepts

No matter what new requirements emerge in the market, TIA supports modular machine concepts and the simple integration of new machines into existing lines – thanks to standardized hardware interfaces and engineering libraries. As a machine builder, this enables you to meet any challenge quickly and reliably.

## Transparent Operation

Integrated interfaces let you achieve a new level of transparency for the essential performance indicators in your processes and plants. The connection between IT and OT along with efficient data management lay the foundation for new service models such as predictive maintenance.

## Future-proof of Automation

Our TIA portfolio is constantly being refined with a view to integrating automation technologies more and more efficiently. The components can then interact with modern IT capabilities, which are becoming increasingly important for specific applications in automation. TIA provides a solid foundation, whether for working with our Industrial Operations X portfolio or for everything the future has in store.

## Sustainable Solutions

Sustainability starts with the acquisition of data. With the TIA portfolio, you can measure energy and resource data and make it transparent, providing a solid foundation for calculating the Product Carbon Footprint. This is crucial for drawing the right conclusions and responding to sudden changes in order to lastingly reduce CO<sub>2</sub> emissions and save more resources in production.

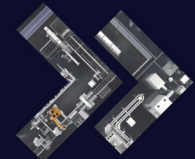

[www.siemens.com/tia](http://www.siemens.com/tia)





# TIA Selection Tool – quick, easy, smart configuration

For you to get the most out of our portfolio quickly and easily.

Do you always need the optimum configuration for planning your project?

For your application we offer the TIA Selection Tool to support all project planners, beginners and experts alike.

No detailed portfolio knowledge is necessary.

TIA Selection Tool is available for download as a free desktop version or a cloud variant.

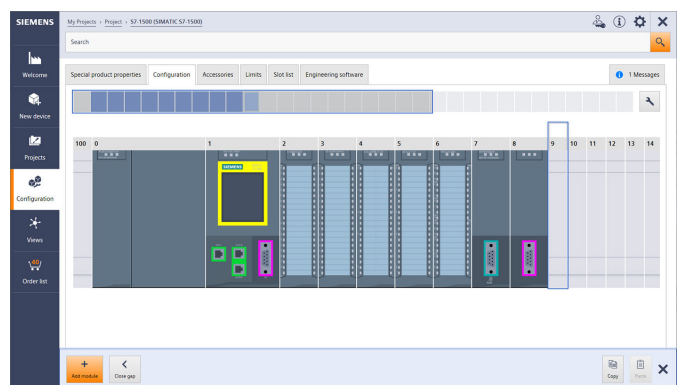

## Your Advantages

### Quick

- Configure a complete project with just a few entries – without a manual, without special knowledge
- Import and export of hardware configuration to TIA Portal or other systems
- Ideal visualization of the projects to be configured

### Easy

- Tool download either as desktop version or web-based cloud version
- Technically always up-to-date about product portfolio and innovative approaches
- Highly flexible, secure, cross-team work in the cloud
- Direct ordering in SiePortal

### Smart

- Smart selection wizard for error-free configuration and ordering
- Configuration options can be tested and simulated in advance
- Library for archiving sample configurations

The TIA Selection Tool is a completely paperless solution.

Download it now:

[www.siemens.com/tst](http://www.siemens.com/tst)

For more  
information,  
scan the  
QR code





# Sustainability @Siemens

Transforming the everyday to create a better tomorrow.

**Decarbonization**

**Ethics**

**Governance**

**Resource Efficiency**

**Equity**

**Employability**

For more information, see [www.siemens.com/sustainability/figures](http://www.siemens.com/sustainability/figures)

As a company, Siemens considers environmental, social and governance (ESG) criteria from all angles with its DEGREE framework (decarbonization, ethics, governance, resource efficiency, equity and employability). We are not only committed to reducing the carbon footprint in our own operations to net zero by 2030, but also helping our customers achieve their decarbonization and sustainability goals.

## Mission & strategy

As a focused technology company, Siemens is committed to addressing the world's most profound challenges by leveraging the synergies between digitalization and sustainability.

## Technology with aim and purpose

We develop technologies that connect the real and digital worlds and enable our customers to positively transform the industries that form the backbone of our economy: industry, infrastructure, transportation and healthcare.

## Our contribution

Siemens makes an impact every day by providing innovative solutions in response to challenges relating to environmental protection, decarbonization, health and safety. Innovative solutions that have a clear goal: to make the world more sustainable, more integrative and a better place to live.

## Sustainability facts

For almost 175 years, Siemens has been driven by the desire to improve the lives of people around the world with our technologies.



Siemens EcoTech is an environmental product performance label designed to drive the sustainable transformation of industry and infrastructure. The label gives you transparency on the performance of our certified products across environmental relevant criteria, enabling you to make informed choices to support your sustainability goals, see [www.siemens.com/SiemensEcoTech](http://www.siemens.com/SiemensEcoTech).



## System overview



1/2	<b>The SINAMICS converter family</b>
1/3	<b>Drive selection</b>
1/4	<b>SIMOTICS motors</b>
1/5	<b>Energy efficiency classes in accordance with IEC 61800-9-2</b>
1/8	<b>SINAMICS Drive Software</b>
1/8	Overview
1/10	<b>Motor Control Functions</b>
1/12	<b>Technology Functions</b>
1/14	<b>SINAMICS G220 built-in and wall-mounted units</b>
1/15	<b>SINAMICS G220 starter kits</b>

Further information about SINAMICS can be found on the internet at [www.siemens.com/sinamics](http://www.siemens.com/sinamics)

# System overview

## The SINAMICS converter family

1

### Overview

#### SINAMICS frequency converters

SINAMICS frequency converters are the ultimate solution for all drive applications. From low voltage to medium voltage to direct current (DC), our frequency converters meet your needs.

With increased efficiency and versatility, take your drive applications to the next generation for a digital and sustainable future.

[www.siemens.com/sinamics](http://www.siemens.com/sinamics)

Low voltage											Direct voltage
Standard performance frequency converters		Distributed frequency converters	Industry-specific frequency converters		Servo converters			High performance frequency converters			DC converters
SINAMICS V20 G120C G120	SINAMICS G130 G150	SINAMICS G115D G120D SIMATIC ET 200pro FC-2	SINAMICS G120X	SINAMICS G180	SINAMICS V90 S200	SINAMICS S110	SINAMICS S210 (6SL5...)	SINAMICS G220	SINAMICS S120 S120M	SINAMICS S150	SINAMICS DCM DCP <sup>1)</sup>
0.12 kW to 250 kW	75 kW to 2700 kW	0.37 kW to 7.5 kW	0.75 kW to 630 kW	2.2 kW to 6600 kW	0.05 kW to 7 kW	0.55 kW to 132 kW	0.05 kW to 7 kW	0.55 kW to 55 kW	0.55 kW to 5700 kW	75 kW to 1200 kW	6 kW to 30 MW
Pumps, fans, compressors, conveyor belts, mixers, mills, spinning machines, textile machines, refrigerated display counters, fitness equipment, ventilation systems, single-axis positioning applications in machine and plant engineering	Pumps, fans, compressors, conveyor belts, mixers, mills, extruders	Conveyor technology, single-axis positioning applications (G120D)	Pumps, fans, compressors, building management systems, process industry, HVAC, water/waste water industries	Pumps, fans, compressors, conveyor belts, extruders, mixers, mills, kneaders, centrifuges, separators	Handling machines, packaging machines, automatic assembly machines, metal forming machines, printing machines, winding and unwinding units	Single-axis positioning applications in machine and plant engineering	Packaging machines, handling equipment, feed and withdrawal devices, stacking units, automatic assembly machines, laboratory automation, wood, glass and ceramics industry, digital printing machines	Pumps, fans, compressors, conveyor belts, mixers, mills, spinning machines, textile machines, refrigerated display counters, fitness equipment, ventilation systems, single-axis positioning applications in machine and plant engineering	Production machines (packaging, textile and printing machines, paper machines, plastic processing machines), machine tools, plants, process lines and rolling mills, marine drives, test bays	Test bays, cross cutters, centrifuges	Rolling mill drives, wire-drawing machines, extruders and kneaders, cableways and lifts, test bay drives
Catalog D 31.1	Catalog D 11	Catalog D 31.2	Catalog D 31.5	Catalog D 18.1	Catalog D 33 D 37.1	Catalog D 31.1	Catalog D 32	Catalog D 36.1	Catalogs D 21.3, D 21.4 NC 62	Catalog D 21.3	Catalog D 23.1, SiePortal

Engineering tools (e.g. Siemens Product Configurator, TIA Selection Tool, DriveSim Designer/Engineer, STARTER and SINAMICS Startdrive)

<sup>1)</sup> DC/DC controllers, see SiePortal.

## Overview

## SINAMICS selection guide – typical applications

Use	Requirements for torque accuracy/speed accuracy/position accuracy/coordination of axes/functionality					
	Continuous motion			Non-continuous motion		
	Basic	Medium	High	Basic	Medium	High
<b>Pumping, ventilating, compressing</b> 	Centrifugal pumps Radial / axial fans Compressors  V20 G120C G120X	Centrifugal pumps Radial / axial fans Compressors  G120X G130/G150 G180 <sup>1)</sup> DCM	Eccentric screw pumps  <b>G220</b> S120	Hydraulic pumps Metering pumps  G120/ <b>G220</b>	Hydraulic pumps Metering pumps  S110	Descaling pumps Hydraulic pumps  S120
<b>Moving</b> 	Conveyor belts Roller conveyors Chain conveyors  V20 G115D G120C ET 200pro FC-2 <sup>2)</sup>	Conveyor belts Roller conveyors Chain conveyors Lifting/ lowering devices Elevators Escalators/ moving walkways Indoor cranes Marine drives Cable railways  G120/ <b>G220</b> G120D G130/G150 G180 <sup>1)</sup>	Elevators Container cranes Mining hoists Excavators for open-cast mining Test bays  <b>G220</b> S120 S150 DCM	Acceleration conveyors Storage and retrieval machines  V90 S200 G120/ <b>G220</b> G120D	Acceleration conveyors Storage and retrieval machines Cross cutters Reel changers  S110 S210 DCM	Storage and retrieval machines Robotics Pick & place Rotary indexing tables Cross cutters Roll feeds Engagers/ disengagers  S120 S210 DCM
<b>Processing</b> 	Mills Mixers Kneaders Crushers Agitators Centrifuges  V20 G120C	Mills Mixers Kneaders Crushers Agitators Centrifuges Extruders Rotary furnaces  G120/ <b>G220</b> G130/G150 G180 <sup>1)</sup>	Extruders Winders/unwinders Lead/follower drives Calenders Main press drives Printing machines  <b>G220</b> S120 S150 DCM	Tubular bagging machines Single-axis motion control such as Position profiles Path profiles  V90 S200 G120/ <b>G220</b>	Tubular bagging machines Single-axis motion control such as • Position profiles • Path profiles  S110 S210	Servo presses Rolling mill drives Multi-axis motion control such as • Multi-axis positioning • Cams • Interpolations  S120 S210 DCM
<b>Machining</b> 	Main drives for • Turning • Milling • Drilling  S110	Main drives for • Drilling • Sawing  S110 S120	Main drives for • Turning • Milling • Drilling • Gear cutting • Grinding  S120	Axis drives for • Turning • Milling • Drilling  S110	Axis drives for • Drilling • Sawing  S110 S120	Axis drives for • Turning • Milling • Drilling • Lasering • Gear cutting • Grinding • Nibbling and punching  S120

## Using the SINAMICS selection guide

The varying range of demands on modern variable frequency drives requires a large number of different types. Selecting the optimum drive has become a significantly more complex process. The application matrix shown simplifies this selection process considerably, by suggesting the ideal SINAMICS drive for examples of typical applications and requirements.

- The application type is selected from the vertical column
  - Pumping, ventilating, compressing
  - Moving
  - Processing
  - Machining
- The quality of the motion type is selected from the horizontal row
  - Basic
  - Medium
  - High

## More information

Further information about SINAMICS is available on the internet at [www.siemens.com/sinamics](http://www.siemens.com/sinamics)

Practical application examples and descriptions are available on the internet at [www.siemens.com/sinamics-applications](http://www.siemens.com/sinamics-applications)

<sup>1)</sup> Industry-specific converters.

<sup>2)</sup> Information on the SIMATIC ET 200pro FC-2 frequency converter is available in Catalog D 31.2 and at [www.siemens.com/et200pro-fc](http://www.siemens.com/et200pro-fc)

## System overview

### SIMOTICS motors

#### Overview

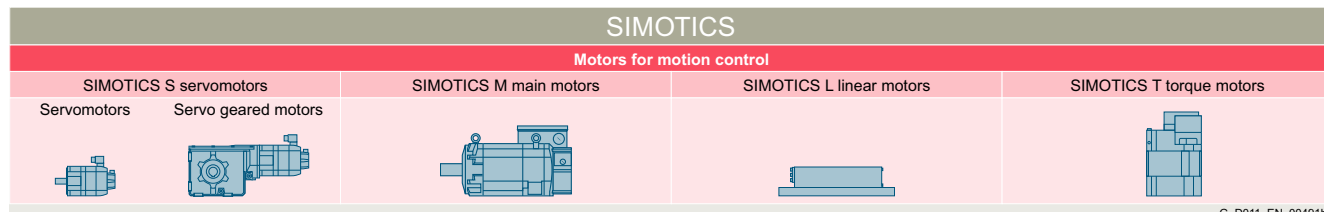

#### **SIMOTICS stands for**

- 150 years of experience in building electric motors
- The most comprehensive range of motors for motion control applications
- Optimum solutions in all industries, regions and power/performance classes
- Innovative motor technologies of the highest quality and reliability
- Highest dynamic performance, precision and efficiency together with the optimum degree of compactness
- Our motors can be integrated into the drive train as part of the overall system
- A global network of skill sets and worldwide service around the clock

#### **A clearly structured portfolio**

The entire SIMOTICS product portfolio is transparently organized according to application-specific criteria in order to help users select the optimum motor for their application.

Whatever it is that you want to move – we can supply the right motor for the task.

[www.siemens.com/simotics](http://www.siemens.com/simotics)

#### **Motors from Innomotics**

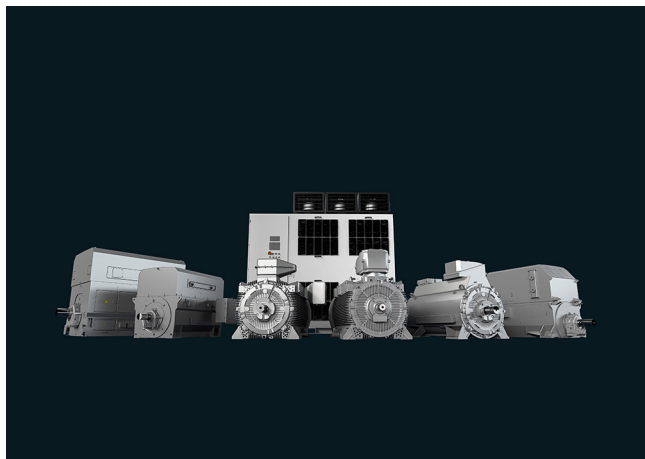

You can also find suitable motors from our product partner Innomotics

[www.innomotics.com](http://www.innomotics.com)

#### **An outstanding performance for any job**

A key characteristic of all SIMOTICS motors is their quality. They are robust, reliable, dynamic and precise to assure the requisite performance level for any process and deliver exactly the capabilities demanded by the application in hand. Thanks to their compact design, they can be integrated as space-saving units into installations. Furthermore, their impressive energy efficiency makes them effective as a means of reducing operating costs and protecting the environment.

#### **A dense network of skill sets and servicing expertise around the world**

SIMOTICS offers not only a wealth of sound experience gleaned from a development history which stretches back over around 150 years, but also the know-how of hundreds of engineers. This knowledge and our worldwide presence form the basis for a unique proximity to industries which feeds through in tangible terms to the specific motor configuration which is tailored to suit your application.

Our specialists are available to answer all your queries regarding any aspect of motor technology. At any time – wherever you are in the world. When you choose SIMOTICS, therefore, you reap the benefits of a global service network which is continuously accessible, thereby helping to optimize response times and minimize downtimes.

#### **Perfection of the complete drive train**

SIMOTICS is perfectly coordinated with other Siemens product families. In combination with the SINAMICS integrated converter family and the SIRIUS complete portfolio of industrial controls, SIMOTICS fits seamlessly as part of the complete drive train into automation solutions which are based on the SIMATIC, SIMOTION and SINUMERIK control systems.



## Overview

### Step by step to more efficiency

One of the core objectives of the European Union is a sustainable power industry. In industrial plants today, around 70 % of the power demand is from electrically driven systems. This high percentage contains huge potential for saving energy in electrical drives. For that reason, the European Union introduced minimum requirements for the energy efficiency of electric motors in the form of a statutory motor regulation as early as 2011.

These activities are extended by the 2019/1781 EU regulation dealing with stricter requirements for DOL (Direct On Line) motors and defining efficiency limits for frequency converters. The regulation provides a legal basis for technical content regarding the efficiency of specific products and services. Standardization, however, has played a leading role in determining the field and the available market technology.

Energy efficiency improvement is supported through a systematic selection of the most efficient converter and drive system technology via the IEC 61800-9 series of standards. Part 1 specifies the methodology to determine the energy efficiency index of an application based on the extended product approach (EPA) and semi analytical models (SAMs), while Part 2 provides indicators for assessing the energy efficiency performance and the classification of converters and drive systems.

To take account of the different use cases, consideration of eight application-relevant operating points has been introduced as mandatory for the first time. Determination of loss values at these eight points and definition of efficiency classes are laid down by the standard in a uniform way. This enables data relevant to operation, such as application-specific load profiles, to now be taken into account more easily in the energy efficiency analysis.

The standard is especially important for variable-speed drives of the following types:

- for AC/AC converters without energy recovery functionality
- for motors with integrated converters
- for supply voltages of 100 V to 1000 V
- for power ratings of 0.12 kW to 1000 kW

To cover all applications of driven machines, the IEC 61800-9-2 standard defines operating points in full-load and partial-load operation, at which the losses of the motor and drive systems have to be determined. Based on the loss data at the operating points in partial-load operation, variable-speed drives can be explicitly considered in more detail. This makes their advantages especially clear.

#### Centrifugal pumps, fans

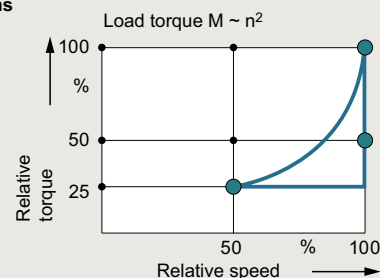

#### Hoisting gear, extruders, conveyor belts

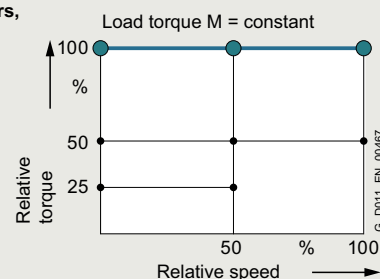

#### Winders, coilers

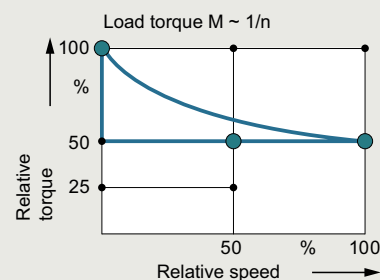

Duty cycles for different driven machines

Moreover, frequency converters and motor systems are classified in efficiency classes, which permit an initial rough estimate of the potential saving. Definition of reference systems is a key aspect of this because they provide standard reference values. The positioning of these reference systems defines the efficiency class. The relative distance from the reference system can be used as an absolute measure of the efficiency at the operating point in question.

## System overview

### Energy efficiency classes in accordance with IEC 61800-9-2

1

#### Overview

##### **Advantages of the detailed loss consideration of IEC 61800-9-2 over the previous consideration of efficiencies and maximum loss values**

For motors, the efficiency consideration was previously only defined for operation without a converter at 50/60 Hz. It provides a good way of comparing the energy efficiency of motors from different manufacturers for this use case.

The more detailed loss analysis of IEC 61800-9-2, on the other hand, is aimed at speed-controlled operation and therefore now also includes motors especially designed for converter operation in the energy analysis. These were previously not covered by the applicable standards.

Moreover, a loss analysis over the entire setting and load range of the motor is possible. This is done in accordance with the standard IEC 61800-9-2 with typical values.

For holistic consideration, it is essential to include all the relevant components of a drive system. The IEC 61800-9-2 standard defines this in detail. The standardized expression of power loss data as a percentage makes comparison considerably easier and more transparent.

The method also makes it possible to consider a motor that produces a holding torque at speed zero, for example. In this case, the efficiency is zero, but a power loss from current producing magnetization and holding torque does occur. In summary, the key advantage of standard IEC 61800-9-2 is the ability to perform the energy analysis of an electrical drive system based on standardized load profiles in all operating ranges due to uniform general conditions. This provides the user with complete transparency irrespective of the manufacturer.

##### **Establishing efficiency classes of frequency converters (Complete Drive Modules CDM)**

To avoid overmodulation and to ensure comparability between makes, which cannot be achieved otherwise, the efficiency classes of CDMs refer to the 90/100 operating point (90 % motor stator frequency, 100 % torque current).

Standard IEC 61800-9-2 defines the relative losses of a CDM in efficiency classes IE0 to IE2. With reference to the value of a CDM of efficiency class IE1 (reference converter), a CDM of efficiency class IE2 has 25 % lower losses and a CDM of efficiency class IE0 has 25 % higher losses.

The publication of the 2019/1781 EU regulation has made mandatory the fulfillment of the ecodesign requirements for the declaration of product conformity.

AC/AC converters belonging to the aforementioned categories (specific voltage and power level without regenerative capability) have to fulfill efficiency class IE2 in order to be approved for installation/utilization within EU.

#### Operating points for CDMs

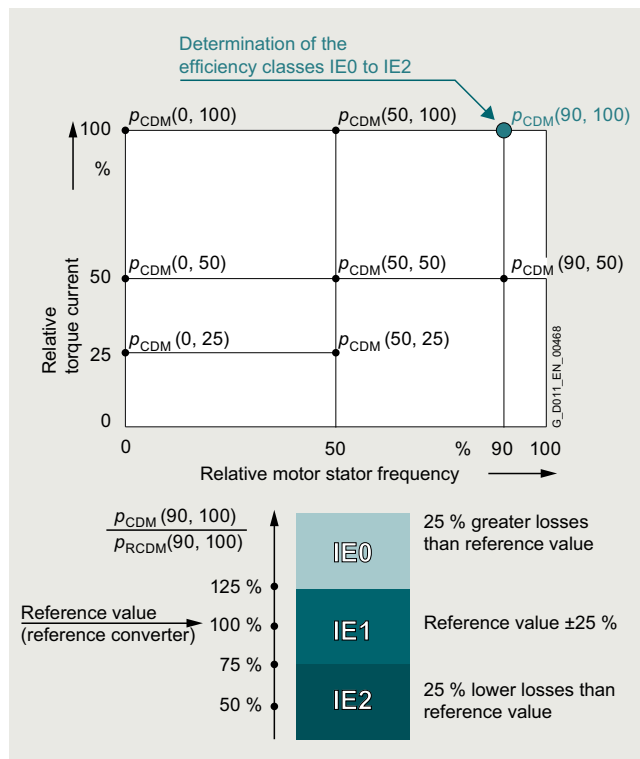

Complete Drive Module (CDM) – determining the efficiency class

##### **Establishing the efficiency classes of drive systems (Power Drive Systems PDS)**

What is possible for the individual systems, of course, also applies to the entire electrical PDS (frequency converter plus motor). Detailed comparisons are now possible at this level, too. The reference values for the reference system provide clear indications of the energy performance of the PDS.

Because targeted matching of the motor and CDM provides additional potential for optimization in electrical drive systems, it is especially important for the user to consider the entire drive system.

For the efficiency class of a PDS, too, a specific load point is defined. In this case, the reference point used is the 100/100 operating point (100 % motor stator frequency, 100 % torque).

Standard IEC 61800-9-2 defines the relative losses of a PDS in efficiency classes IES0 to IES2. With reference to the value of a PDS of efficiency class IES1 (reference drive), a PDS of efficiency class IES2 has 20 % lower losses and a PDS of efficiency class IES0 has 20 % higher losses.

Energy efficiency classes in accordance with IEC 61800-9-2

Overview

Operating points for PDS

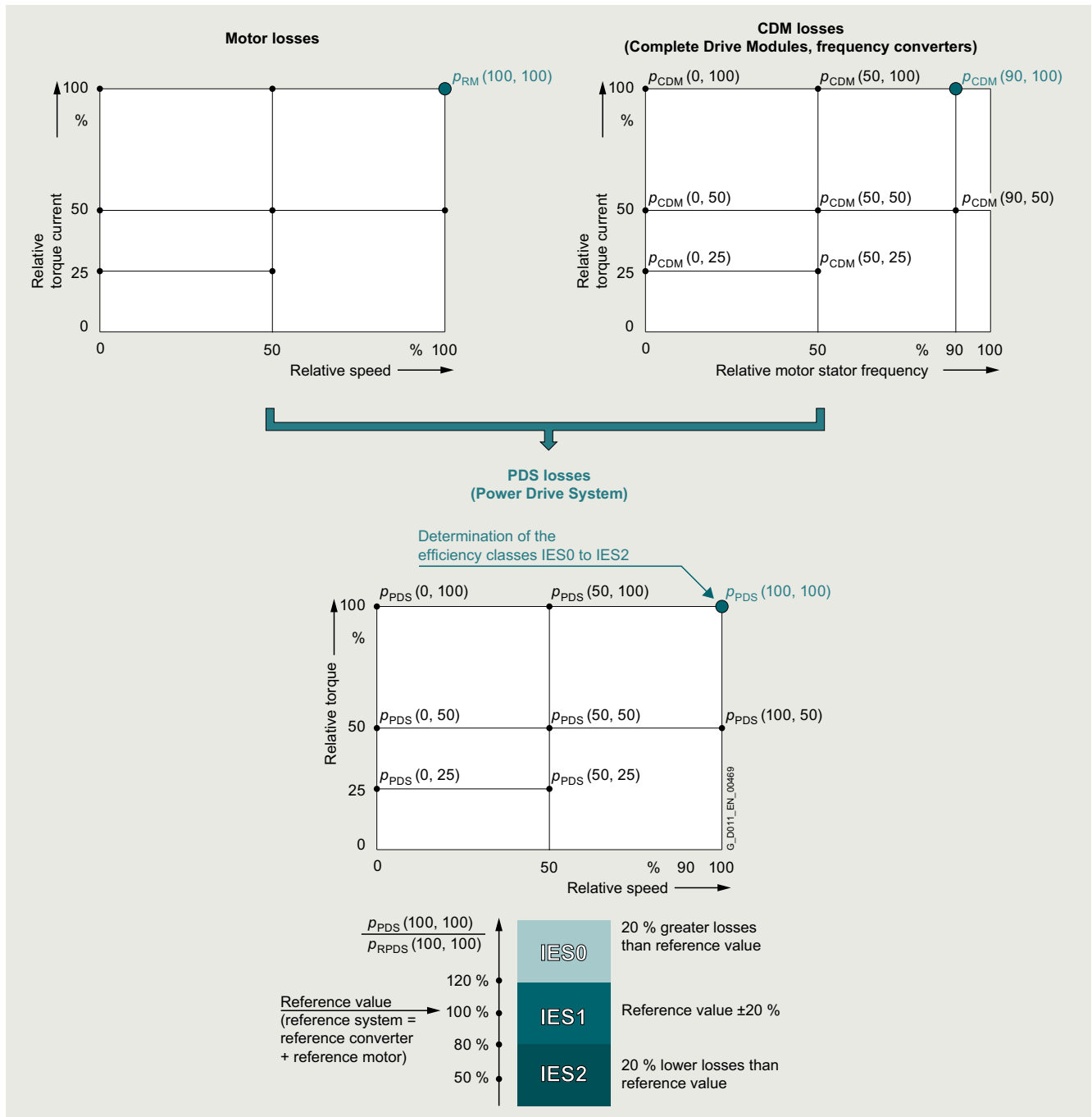

Power Drive System (PDS) – determining the efficiency class

More information

Power loss data of SINAMICS converters for single-axis drives are available

- for SINAMICS V20, SINAMICS G115D/G120/G120C/G120D/G120P/G120X/G130/G150/G180 and SINAMICS S110/S120/S150 on the internet at <https://support.industry.siemens.com/cs/document/94059311>
- for SINAMICS G220 via ID-Link or Siemens Product Configurator in SiePortal at [www.siemens.com/sinamics-g220/configuration](http://www.siemens.com/sinamics-g220/configuration)

More information on current laws and standards, new standards, and mandatory guidelines is available on the internet at [www.siemens.com/legislation-and-standards](http://www.siemens.com/legislation-and-standards)

## System overview

### SINAMICS Drive Software > Overview

#### Overview

#### **SINAMICS Drive Software – The right function for every application**

SINAMICS Drive Software ensures that our SINAMICS frequency converters operate smoothly and reliably.

It offers comprehensive functionality, is easily expandable and enables the greatest possible flexibility for a wide range of applications.

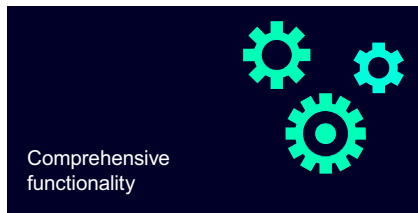

#### **Comprehensive functionality**

The software enables highly accurate and dynamic control of different types of motors.

Integrated functions help to reduce energy consumption. The software protects the converter against overload and ensures high availability. Furthermore, positioning tasks as well as logic and technology functions can be taken over directly by the drive.

The Safety Integrated functions ensure maximum safety for operating and maintenance personnel. The special requirements of industries and applications e. g. pumps, fans and conveyor technology are met by specific functions.



#### **Easily expandable**

Most of the SINAMICS Drive Software functionality is already included in the basic scope of our frequency converters.

However, the scope of performance can be further increased via additional SINAMICS Drive Software options.

These options allow the use of special added value or expansion functions.

For example, the SINAMICS Safety Integrated Extended option provides additional safety functions compared to the basic version.



#### **Greatest flexibility**

The additional SINAMICS Drive Software options can easily be ordered together with the SINAMICS frequency converter.

You do not know which options you need at the beginning?

No problem, besides options that can be ordered directly at the time of purchase, some options can also be ordered later.

Before purchasing, you can test the SINAMICS Drive Software options free of charge for a limited time (trial license concept).

SINAMICS Drive Software highlights from firmware V6.4:

- OPC UA server with information model for inventory management and process data acquisition (will soon be available in a V6.4 HF)
- Security:
  - Security event log for sending security events via syslog protocol to a server
  - Additional UMAC privileges for security configuration
  - Integrity protection for backups
  - Extended handling of certificates
- User experience:
  - Update SINAMICS web server for SINAMICS G220
- Integrated Positioning:
  - Positioning Extended (EPOS) available for SINAMICS G220
  - Higher resolution through 64-bit data type for position values together with new telegram 113
  - Load gearbox position tracking support for reproducibility of the load position when using gears
- Vibration suppression support for the reduction of vibrations in the natural frequency range up to 10 Hz
- Configurable supplementary telegram for handover additional data to the PLC
- SINAMICS DCC (Drive Control Chart) available for SINAMICS G220
  - SINAMICS DCC enhances converter systems with customizable closed-loop control, arithmetic, and logic blocks, offering unmatched flexibility and efficiency for machine-specific functions
- Additional Safety Integrated Functions SS1E, SS2, SS2E, SOS and SLA for SINAMICS G220
- Additional and improved Motor Control Functions for SINAMICS G220
  - Additional motor support e.g. SIMOTICS M-1PH3, 1PH8, SIMOTICS S-1FK7, 1FG1 and SIMOTICS T-1FW3, 1FW4
  - Easy commissioning for 3rd party motors

## Overview

**Motor Control Functions**

Basic – but most important!  
From standard pump and fan applications to high-end drives with complex multi-axis servo applications: Motor control with SINAMICS drives is always perfect. A wide variety of motor technologies and performance levels with optimal settings for all applications can be controlled. Just the perfect control for your task!

**User Experience**

An excellent user experience is given throughout the whole engineering chain as well as throughout the whole drives portfolio due to consistent Ethernet-based interfaces, communication protocols (wired or wireless) as well as up to date browser technologies.

All of the converter functions have been designed so that they can be handled in the same way from an engineering perspective, irrespective of the selected drive type. Knowledge gained can therefore be reused easily and efficiently.

[www.siemens.com/engineering-tools](http://www.siemens.com/engineering-tools)

**Security Integrated Functions**

Keep systems and data safe with Security Integrated.

With the new Security Integrated functions, we are protecting SINAMICS drives against cyber attacks from the outside (available for SINAMICS S200, SINAMICS S210 (New), SINAMICS G220).

[www.siemens.com/industrial-cybersecurity](http://www.siemens.com/industrial-cybersecurity)

**Connectivity Functions**

Consistent openness today and tomorrow.

SINAMICS offers a comprehensive range of communication options for engineering, exchanging data between drives – and naturally for exchanging data with higher level automation systems.

[www.siemens.com/profinet](http://www.siemens.com/profinet)

**Technology Functions**

The SINAMICS drives' range of applications is significantly expanded by the Technology Functions. From logic to positioning and more – everything on board!

**Safety Integrated Functions**

SINAMICS drives offer comprehensive and integrated safety functions. These act significantly faster than conventional designs. As a consequence, Safety Integrated further increases the safety of a machine.

[www.siemens.com/safety-drives](http://www.siemens.com/safety-drives)

**Energy Efficiency and Grid Capability Functions**

Energy is valuable and should be used as efficiently as possible. SINAMICS drives offer integrated functions for energy efficiency and naturally also support PROfinenergy.

[www.siemens.com/drives-energy-efficiency](http://www.siemens.com/drives-energy-efficiency)

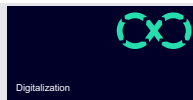
**Digitalization in drive technology**

Getting started in drive technology digitalization is very easy. We offer suitable digitalization solutions for low-voltage motors and low-voltage converters for every phase in the life cycle of a machine or plant. Our portfolio extends from the digital to the real drive train. Thanks to continuous integration, it is possible to start today in one area with little effort – and use the information acquired elsewhere tomorrow.

[www.siemens.com/digital-drivetrain](http://www.siemens.com/digital-drivetrain)

**More information**

Further information about SINAMICS Drive Software is available on the internet at:  
[www.siemens.com/sinamics-drive-software](http://www.siemens.com/sinamics-drive-software)

## System overview

### SINAMICS Drive Software > Motor Control Functions > "SINAMICS Motor Control Extended" for SINAMICS G220

#### Overview

Motor Control Functions				
<b>Motor Control Functions</b>				
<b>Control philosophy</b>				
<b>Drives</b>	<b>SINAMICS S</b> Multi-axis			
	<b>SINAMICS G</b>			<b>SINAMICS S</b> Single-axis
<b>Control mode</b>	<b>Vector Control</b>			<b>Servo Control</b>
	<b>Standard Drive Control</b>	<b>Dynamic Drive Control</b>	<b>Expert Mode</b>	<ul style="list-style-type: none"> <li>• Special closed-loop control for highest dynamics servo motor applications</li> <li>• Especially important for machine tool applications</li> </ul>
	<ul style="list-style-type: none"> <li>• Pumps, fans and compressors with flow characteristic</li> <li>• Blasting technology</li> <li>• Mills, mixers, kneaders, crushers, agitators</li> <li>• Horizontal conveyor technology</li> <li>• Basic spindles</li> </ul>	<ul style="list-style-type: none"> <li>• Demanding applications with high utilization of the motor/converter</li> <li>• Pumps and compressors with displacement machines</li> <li>• Extruders</li> <li>• Centrifuges</li> <li>• Vertical conveyor technology</li> </ul>	<ul style="list-style-type: none"> <li>• All applications</li> <li>• All setting options are available</li> </ul>	
<b>Required data</b>	Rated speed and rated current	Rated speed, rated current and rated power	Depending on commissioning routine	Depending on commissioning routine
<b>Focus</b>	Easy & fast commissioning for the untrained user	Simplified commissioning for most applications	Maximum performance for the expert user	Maximum performance for the expert user

#### Motor control modes

The control methods are the core of the entire converter firmware. They are responsible for optimum movement of the connected motor and the attached machines. The better the control functions, the faster, better and more smoothly the machine operates, thereby significantly enhancing the quality of the production output.

#### Open loop control

The U/f open-loop control characteristic is the simplest way to control an induction motor. Several different characteristics, e. g. linear or parabolic, can be configured. In addition, basic functions like slip compensation, voltage boost or resonance damping are supported.

#### Universal closed-loop control (Vector Control)

The vector control emulates the motor as precisely as possible to obtain the best results regarding control precision and control quality.

For most applications and motors, the closed-loop vector control is the perfect choice. It is optimized for both Siemens and 3rd party motors.

Unknown motors – regardless of the technology (induction, synchronous reluctance, permanent magnet synchronous) – can be identified and commissioned easily.

The vector control is characterized by features like

- Best speed accuracy
- Best speed ripple
- Best torque accuracy
- Best torque ripple
- Optimized for control with or without encoder

#### Closed-loop control for highest dynamics (Servo Control)

In the servo control mode, the connected motor is emulated in a vector model based on its equivalent circuit diagram data.

Consequently, the servo control constitutes a field-oriented control. In contrast to vector control, the vector model is optimized according to other criteria in servo control.

In favor of achieving a high dynamic performance, a small deterioration in the control accuracy and control quality is accepted.

Special features of the servo control include

- Maximum computing speed
- Shortest sampling times
- Maximum dynamic performance
- High output frequencies
- Preferably used with permanent magnet synchronous motors with encoder for the appropriate dynamic performance

#### General control loop structures

Both servo and vector control share some common used control-loop structures:

- Extended brake control. It allows complex brake controls, such as for motor holding brakes and service brakes.
- Setpoint channel. It is the link between the setpoint source and the motor control. The converter has a special feature that supports simultaneous input of two setpoints. Generation and subsequent modification of the total setpoint (influencing the direction, skip frequency, up/down ramp) take place in the setpoint channel.
- Command sources. Different sources of command usually result from the requirements to operate a drive from different places (on-site/remote), in different situations (standard/emergency mode) and/or different operating. The BICO binector connector technology allows to configure and combine the command and setpoint sources completely individually.
- Limiters or limits are used to constrain input and/or output variables as appropriate to the connected machine; this means that not all positioning variables are used over their full range but are limited judiciously to enhance the safety and quality of the production process.
- Pulse frequency & modulation. Several different pulse frequencies possible to adjust the drive to the application including asynchronous pulse frequencies to minimize derating and mechanical resonances. In addition, wobbling is available to generate a more pleasant acoustic experience.



## Overview

The software option SINAMICS Motor Control Extended for SINAMICS G220 enables high-performance encoderless closed-loop control of synchronous reluctance motors from standstill, by enabling pulse technique at very low speeds.

### Main benefits

- Reduces commissioning time and effort (less configuration, tuning and wiring)
- Saves energy due to permanent operation in closed-loop vector control
- Saves cost for encoder, cable, installation, spares, etc.
- Allows continuous operation at near zero speeds including torque control
- Improves system stability and robustness
- Improves drive dynamic performance
- Improves reliability and availability by reducing system complexity

### Example 1: Low speeds, robustness and energy efficiency

The following diagram shows a measured load cycle. In the low speed range, the software option SINAMICS Motor Control Extended leads to significant reduced currents and therefore increased energy efficiency. Also, continuous operation with high loads is possible near zero speed.

When medium speeds are reached (in diagram: rectangle), the control switches from the pulse technique to standard sensorless vector control.

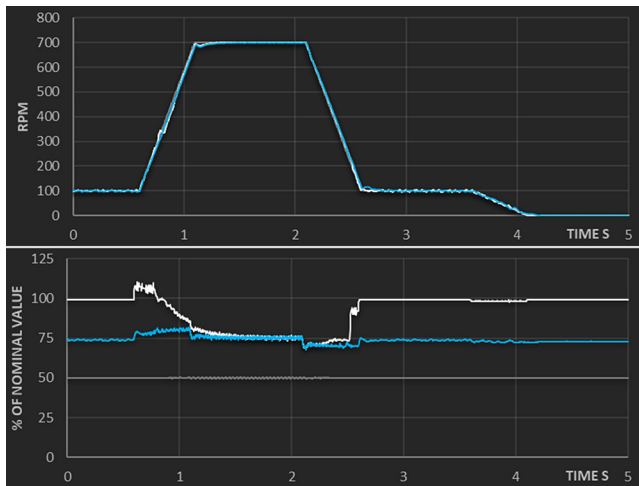

### Example 2: Dynamic behavior

In the following measurement, a sinusoidal signal was used to demonstrate the dynamic performance of the pulse technique. The sinusoidal signal is reproduced perfectly with the pulse technique while maintaining a relatively low current compared to the standard sensorless control near zero speed. For higher sinusoidal frequencies, the standard control would not be able to work.

This shows perfectly that with the software option SINAMICS Motor Control Extended, also high dynamic applications that need fast reaction times at low speeds without ramps are possible.

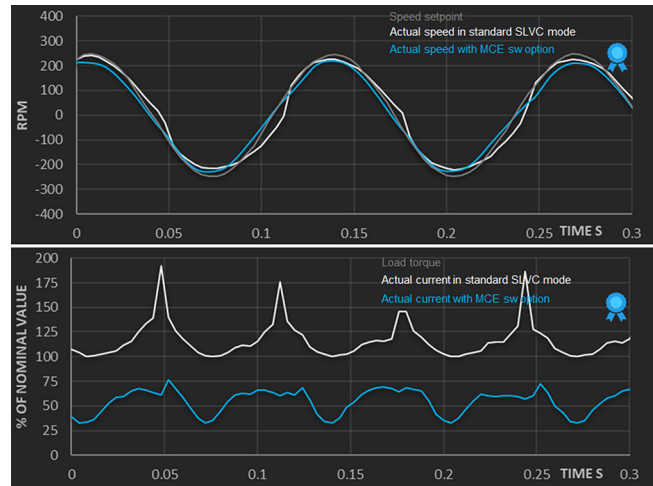

### In which cases should SINAMICS Motor Control Extended be used?

With synchronous reluctance motor drive

- the application requires frequent or long or even permanent operation at very low speeds during operation cycle and/or precise torque control from 0 r/min is required (e. g. winders, mixers, extruders).
- If the load peak at start is difficult to predict or changes dynamically and/or positioning in the application is required (e. g. logistics, cranes, hoists).
- If the drive dynamic performance is critical, requiring operation with no or very short ramps in closed-loop (e. g. servo pumps).
- If the motor works in harsh conditions or it is impossible to use an encoder (dust, heavy vibrations, mechanical restrictions) (e. g. heavy industry).

### SD card



### Selection and ordering data

Description	Article No.
<b>Delivery with SINAMICS SD memory card, 8 GB</b>	
SINAMICS Motor Control Extended (license)	<b>6SL5970-0AA00-0AA0-Z H01</b>
With firmware V6.4 and SINAMICS Motor Control Extended (license)	<b>6SL4170-1GE00-0AA0-Z H01</b>
<b>Delivery in electronic form, eCOL (without memory card)</b>	
SINAMICS Motor Control Extended (license)	<b>6SL5977-0AA00-1DA0</b>



## System overview

### SINAMICS Drive Software > Technology Functions

#### Overview

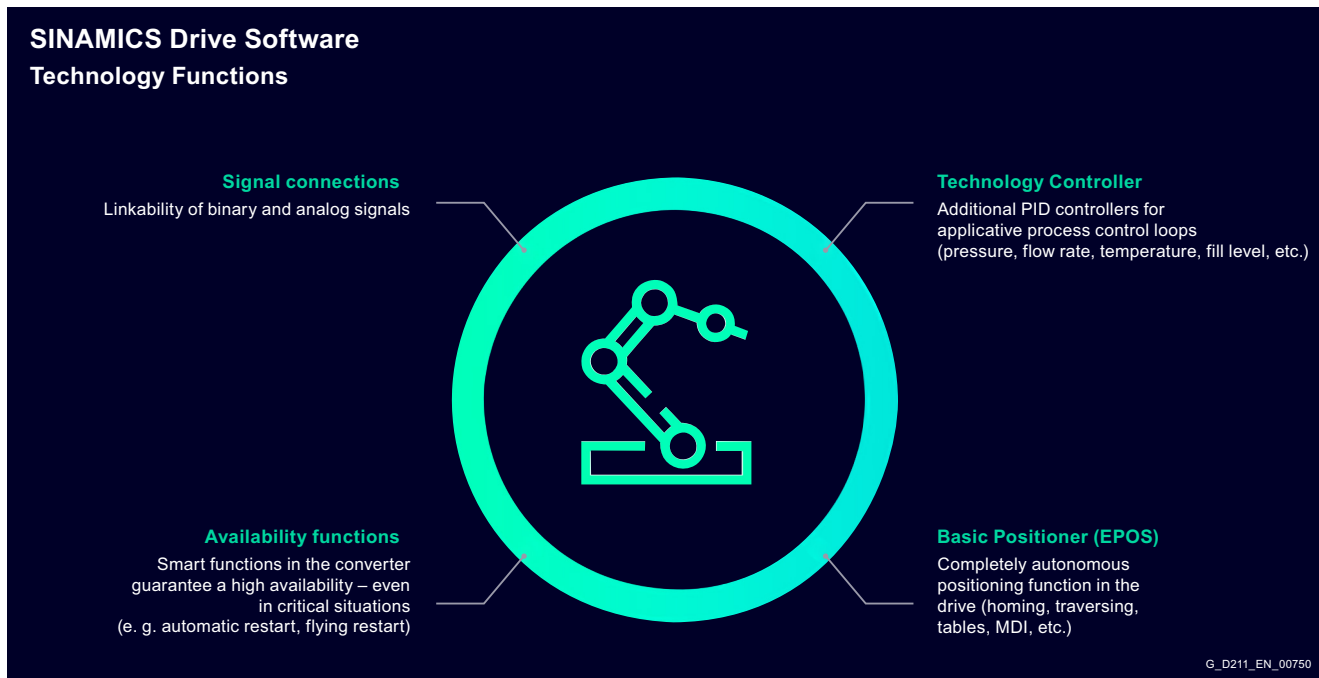

#### **Signal connections**

Create new functions by intelligently interconnecting sub-functions. Signal Connect gives you the flexibility you need to configure customized solutions to meet your needs.

#### **Basic Positioner**

The basic positioner provides powerful and precise positioning functions. Due to its flexibility and adaptability, the basic positioner (EPOS) can be used for a wide range of positioning tasks.

The functions are easy to use during both commissioning and operation, and the comprehensive monitoring functions are very powerful.

As a consequence, many applications can be implemented without having to use external position controls.

#### **Technology Controller**

The technology controller is implemented as a PID controller for performing all kinds of process control tasks. It can be used to control the line pressure, fill level, temperature, flow or tension control, or load balancing etc.

#### **Availability functions**

Smart functions in the converter guarantee a high availability – even in critical situations. These functions are e. g. automatic restart, flying restart, kinetic buffering, overvoltage limitation, keep running mode and emergency operation mode.

## Function

### Signal interconnection

The SINAMICS drive system allows input and output signals of different SINAMICS Drive Software functions to be interconnected with one another. In addition to setting parameters, the ability to interconnect signals is an additional option of adapting SINAMICS Drive Software functions to address the particular application. Signal connection enables flexible adaptation of SINAMICS to a wide range of the customer requirements.

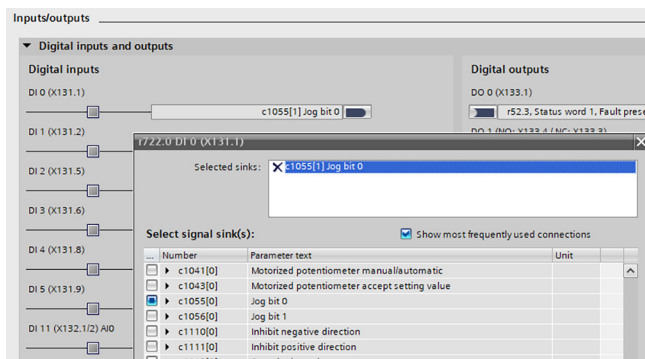

### Technology Controller

The integrated technology controller in SINAMICS Drive Software enables precise control of process variables such as pressure, temperature, level and flow. With a wide range of additional functions, the technology controller offers an optimum solution for your individual requirements:

**Setpoint specification:** Flexible selection between analog value and fixed setpoint in order to achieve the desired objective precisely.

**Setpoint channel:** With functions such as scaling, ramp-function generator and filter, you have full control over the desired setpoint.

**Actual value channel:** Use filtering, limiting and signal conditioning for precise acquisition and processing of the actual value.

**PID controller:** Optimize the performance of your control system by individually setting the D component, blocking the I component and adjusting the control sense.

**Enabling and limiting the controller output:** Control the output of the controller as required and set individual limits to ensure the stability of your processes.

**Fault reaction:** Our PID controller reacts to errors that occur, ensuring reliable and safe control of your process parameters.

The technology controller not only offers precision, but also user-friendliness and adaptability. Rely on proven technology for optimum results in your applications!

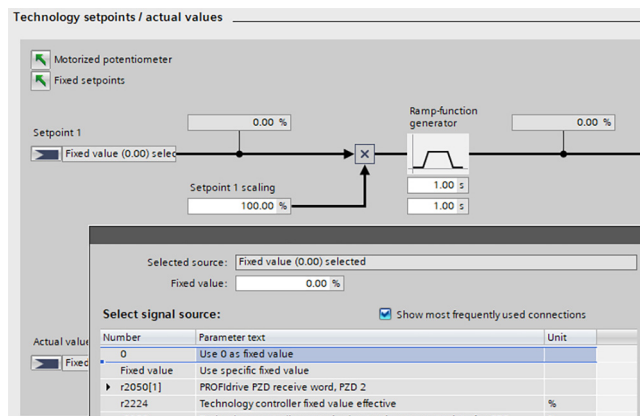

### Availability functions

The following smart functions are available to increase availability:

#### Automatic restart:

Use the powerful automatic restart function in the SINAMICS drive system to ensure a reliable and automatic restart. This innovative function enables seamless power recovery, especially after a power failure.

Any faults that occur are automatically acknowledged and the drive restarts automatically. This functionality goes beyond mains faults and can be used flexibly for any fault shutdowns. The automatic restart function therefore offers a comprehensive solution for critical situations.

Thanks to its adaptability and reliability, this function minimizes downtimes and increases the overall availability of the drive system.

#### Flying restart:

Experience the impressive "flying restart" function – an intelligent solution that allows your motor module to seamlessly switch to a motor that may already be rotating after it has been switched on. This advanced function can be activated both in operation with and without an encoder and offers maximum application versatility.

A practical example illustrates the performance of this function: After a power failure, a fan drive can be quickly synchronized with the running fan motor again thanks to the "flying restart" function. This enables operation to be resumed as quickly as possible and significantly minimizes downtimes.

Integrate the "flying restart" function into your drive systems and benefit from reliable, flexible and efficient motor control – exactly when it matters.

## System overview

1

### SINAMICS G220 built-in and wall-mounted units

#### Overview



Example: SINAMICS G220 built-in units, degree of protection IP20 / UL Open Type, frame sizes FSA, FSB, FSC, FSD1, FSD2 and FSE



Example: SINAMICS G220 wall-mounted units, degree of protection IP55 / UL Type 12, version without a maintenance switch, frame sizes FSB, FSC, FSD1, FSD2 and FSE

The SINAMICS G220 built-in and wall-mounted units are efficient, secure, and future-proof frequency converters that have been specifically developed for high-performance applications in manufacturing, process industries, and marine.

This converter series sets itself apart, especially as a result of its advanced motor control, high flexibility, very simple selection and operation, as well as fast commissioning, low harmonics, and long cable lengths. SINAMICS G220 built-in and wall-mounted units allow for increased availability of the plant or system and optimize energy efficiency.

SINAMICS G220 converter series provides a complete and seamless range of products:

- Voltage versions and power ratings:
  - 200 V to 240 V 3 AC: 0.55 kW to 30 kW (0.75 hp to 40 hp)
  - 380 V to 500 V 3 AC: 1.1 kW to 55 kW (1.5 hp to 40 hp)
  - 525 V to 690 V 3 AC (available in the future)
- Degrees of protection (IP20 / UL Open Type and IP55 / UL Type 12)
- Clean Power to reduce line harmonics
  - 380 V to 500 V 3 AC: 7.5 kW to 55 kW
- Power ratings from 55 kW up to 1 MW available in the future

## Overview



SINAMICS G220 starter kit incl. SINAMICS Smart Adapter

A SINAMICS G220 starter kit comprises a SINAMICS G220 converter (200 V or 400 V 3 AC; PROFINET / Modbus TCP/IP, EtherNet/IP) with SINAMICS Smart Adapter for Wi-Fi access to the integrated web server of the converter.

The delivery quantity is limited to three units per customer.

The SINAMICS G220 starter kits can be combined with the SIMATIC starter kits. In this way, simple drive tasks up to motion control applications can be quickly implemented.

## Selection and ordering data

Description	Article No.
<b>SINAMICS G220 starter kits</b> SINAMICS G220 converter (3 AC, PROFINET / Modbus TCP/IP, EtherNet/IP) with SINAMICS Smart Adapter for Wi-Fi access to the integrated web server.	
<ul style="list-style-type: none"> <li>• <b>200 V to 240 V 3 AC, IP20 / UL Open Type,</b> 2.2 kW, FSA, without integrated line filter</li> </ul>	<b>6SL4990-0AE10-0AA0</b>
<ul style="list-style-type: none"> <li>• <b>380 V to 500 V 3 AC, IP20 / UL Open Type,</b> 4 kW, FSA, with integrated line filter Category C2 (removable)</li> </ul>	<b>6SL4990-0AE11-0AA0</b>
<ul style="list-style-type: none"> <li>• <b>380 V to 500 V 3 AC, IP20 / UL Open Type,</b> 7.5 kW, FSB, with integrated line filter Category C2 (removable), SINAMICS SDI Pro 5.5" handheld kit</li> </ul>	Available soon
<ul style="list-style-type: none"> <li>• <b>380 V to 500 V 3 AC, IP55 / UL Type 12,</b> 5.5 kW, FSB, with integrated line filter Category C2 (removable)</li> </ul>	Available soon
<ul style="list-style-type: none"> <li>• <b>380 V to 500 V 3 AC, Clean Power, IP20 / UL Open Type,</b> 7.5 kW, FSD1, with integrated line filter Category C2 (removable)</li> </ul>	Available soon
<ul style="list-style-type: none"> <li>• <b>380 V to 500 V 3 AC, Clean Power, IP55 / UL Type 12,</b> 15 kW, FSD1, with integrated line filter Category C2 (removable), SINAMICS SDI Pro 5.5" with SINAMICS IP55 panel mounting frame</li> </ul>	Available soon

## System overview

Notes

1

## SINAMICS G220 built-in and wall-mounted units



<b>2/2</b>	<b>SINAMICS G220 built-in and wall-mounted units</b>
2/2	Overview
2/6	Benefits
2/6	Integration
2/8	Characteristic curves
2/10	Dimensional drawings
2/12	Selection and ordering data
2/12	IP20/UL Open Type 200 ... 240 V 3 AC · 0.55 kW to 30 kW
2/14	IP20/UL Open Type 380 ... 500 V 3 AC · 1.1 kW to 55 kW
2/16	IP55/UL Type 12 200 ... 240 V 3 AC · 1.1 kW to 30 kW
2/18	IP55/UL Type 12 380 ... 500 V 3 AC · 1.1 kW to 55 kW
2/20	Clean Power/IP20/UL Open Type 380 ... 500 V 3 AC · 7.5 kW to 55 kW
2/22	Clean Power/P55/UL Type 12 <b>NEW</b> 380 ... 500 V 3 AC · 7.5 kW to 55 kW
2/24	Supplementary system components for SINAMICS G220 built-in and wall-mounted units
2/25	Technical specifications
<b>2/41</b>	<b>Safety Integrated for SINAMICS G220</b>
<b>2/43</b>	<b>Supplementary system components</b>
2/43	Option Modules
2/43	OM-DQ Option Module DRIVE-CLiQ
2/44	OM-IIoT Option Module IIoT
2/45	OM-SMT Option Module Safe Motor Temperature
2/46	Smart Drive Interfaces
2/47	SINAMICS SDI Standard
2/49	SINAMICS SDI Pro 5.5"
2/54	SINAMICS Smart Adapter
2/56	Encoder system connection
2/56	SMC10 Sensor Module Cabinet-Mounted
2/57	SMC20 Sensor Module Cabinet-Mounted
2/58	SMC30 Sensor Module Cabinet-Mounted

### Further information about SINAMICS G220

can be found on the internet at  
[www.siemens.com/sinamics-g220](http://www.siemens.com/sinamics-g220)

**Technical data and configuration**  
can be found on the internet at  
[www.siemens.com/sinamics-g220/  
documentation](http://www.siemens.com/sinamics-g220/documentation)

and concerning ordering and configuration  
via the Siemens Product Configurator in  
SiePortal:

[www.siemens.com/sinamics-g220/  
configuration](http://www.siemens.com/sinamics-g220/configuration)



## SINAMICS G220 built-in and wall-mounted units

### Overview



Example: SINAMICS G220 built-in units, degree of protection IP20 / UL Open Type, frame sizes FSA, FSB, FSC, FSD1, FSD2 and FSE



Example: SINAMICS G220 wall-mounted units, degree of protection IP55 / UL Type 12, version without a maintenance switch, frame sizes FSB, FSC, FSD1, FSD2 and FSE

The SINAMICS G220 built-in and wall-mounted units are efficient, secure, and future-proof frequency converters that have been specifically developed for high-performance applications in manufacturing, process industries, and marine.

This converter series sets itself apart, especially as a result of its advanced motor control, high flexibility, very simple selection and operation, as well as fast commissioning, low harmonics, and long cable lengths. SINAMICS G220 built-in and wall-mounted units allow for increased availability of the plant or system and optimize energy efficiency.

SINAMICS G220 converter series provides a complete and seamless range of products:

- Voltage versions and power ratings:
  - 200 V to 240 V 3 AC: 0.55 kW to 30 kW (0.75 hp to 40 hp)
  - 380 V to 500 V 3 AC: 1.1 kW to 55 kW (1.5 hp to 40 hp)
  - 525 V to 690 V 3 AC (available in the future)
- Degrees of protection (IP20 / UL Open Type and IP55 / UL Type 12)
- Clean Power to reduce line harmonics
  - 380 V to 500 V 3 AC: 7.5 kW to 55 kW
- Power ratings from 55 kW up to 1 MW available in the future



## Overview

### Enjoy a new efficiency level and let your technology do the work for you

The SINAMICS G220 is a compact and efficient converter solution for a wide range of applications. It offers highly efficient commissioning, diagnostics and maintenance thanks to the engineering tools.

#### SINAMICS web server for SINAMICS G220

Web server for efficient commissioning, diagnostics, maintenance and operator control and monitoring, any time, from anywhere.

#### SINAMICS SDI Standard (Smart Drive Interface)

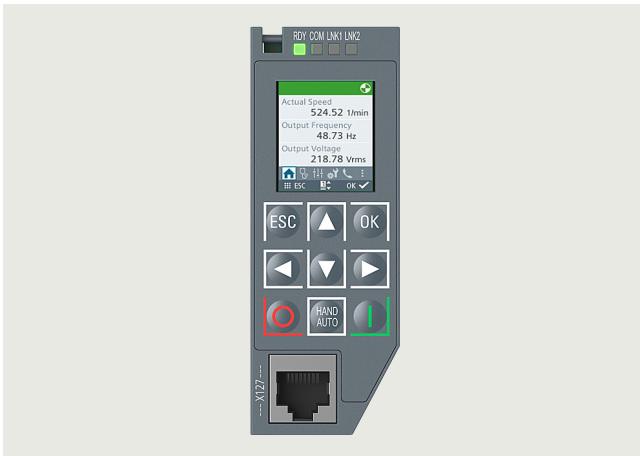

The SINAMICS SDI Standard is a highly user-friendly Operator Panel for the SINAMICS G220. The SDI Standard supports newcomers and drive experts alike with essential tasks locally on the device. Thanks to its high-contrast 1.4" color display and membrane keyboard, the device can assist with diagnosing faults in plain text, operation and monitoring, and with maintenance and servicing of the converter on site. The SINAMICS SDI Standard is included in the scope of delivery of the converters.

#### SINAMICS SDI Pro 5.5" (Smart Drive Interface)



SINAMICS SDI Pro 5.5", Handheld

The SINAMICS SDI Pro 5.5" represents a powerful and user-friendly Operator Panel for SINAMICS G220. The SDI Pro supports both newcomers and drive experts. Thanks to its touch interface and high-contrast 5.5" color display, it goes hand-in-glove for commissioning, diagnostics, operator control and monitoring as well as on-site maintenance and servicing of converters.

The additional available options, such as the SINAMICS SDI Pro 5.5" handheld kit and SINAMICS SDI Pro 5.5" door mounting kit, extend the operating range of the device. With the SDI Pro 5.5" handheld kit, the device can be equipped with a rubber overshooth for mobile use. The SINAMICS SDI Pro 5.5" door mounting kit enables the SINAMICS SDI Pro to be installed in control cabinet doors.

#### SINAMICS Smart Adapter



SINAMICS Smart Adapter

SINAMICS Smart Adapter is a Wi-Fi solution for engineering, service and maintenance tasks with the next generation of SINAMICS converters. The adapter is designed to be plugged into and powered from the service interface (X127) on the converter.

#### SINAMICS Startdrive commissioning tool in TIA Portal

Integration via PROFINET communication, Modbus TCP or EtherNet/IP into a higher-level control system has never been so easy thanks to the full integration of SINAMICS G220 into the SINAMICS Startdrive commissioning tool in TIA Portal. In combination with SIMATIC S7-1500, the SINAMICS G220 drive with PROFINET communication is a harmonized and coordinated motion control solution in TIA Portal. The connection to the SINAMICS G220 converter is made via clock-synchronous PROFINET IRT and the safety connection (in case of faulty SIMATIC S7-1500F) directly via PROFSafe. This approach reduces engineering times and increases productivity.

## SINAMICS G220 built-in and wall-mounted units

### Overview

More efficient and sustainable due to minimized harmonics



The SINAMICS G220 is the first choice for anyone seeking an energy efficient converter. The innovative **SINAMICS G220 Clean Power** effectively reduces line harmonics. With its revolutionary and integrated active infeed unit, harmonics are reduced to the minimum and the total harmonic current distortion is typically less than 2 %. No additional options are required to comply with IEEE 519 reducing the material footprint for a more sustainable industry.

In addition, the advanced hardware and software functions of SINAMICS G220 provide reliable motor control of high efficiency motors such as synchronous reluctance motors and permanent magnet synchronous motors.

SINAMICS G220 is designed for long cable lengths and it can reach to up to 150 m according to C2 EMC Category. Integrated DC link reactor is also available in all power ratings and a wide portfolio of energy saving functions.

#### **Master tomorrow's challenges today with safe and secure technology**

SINAMICS G220 provides Security Integrated functions increasing the level of data security to comprehensively protect industrial plants and systems from cyber attacks – from both inside and outside. SINAMICS G220 "Defense in Depth" security concept ensures and provides individual user management including access control along with secure communication between the variable frequency converter and the TIA Portal engineering system or web client. It reliably protects availability through Security Integrated functions.

Furthermore, this new variable frequency converter is equipped with Safety Integrated functions up to SIL3 (safety integrity level) and PL e (performance level) according to IEC 62061 and ISO 13849-1 standards. This means that the system and the machine comply with strict safety requirements.

Local safety concepts can be implemented by controlling the integrated safety functions via fail-safe terminals as well as integrated in the automation via fail-safe PROFIsafe communication profile.

The variable frequency converter is equipped with the following safety functions as standard:

- Safe Torque Off (STO)
- Safe Stop 1 time-controlled (SS1-t)
- Safe Motor Temperature (SMT) in combination with the optional OM-SMT Option Module Safe Motor Temperature → New functionality, which allows an easy integration of safe motor temperature monitoring for ATEX applications. Option module OM-SMT Safe Motor Temperature is required.

Extended safety functions can be simply added via the Safety Integrated Extended software option:

- Safe Stop 1 (SS1) with SBR/SAM
- Safely Limited Speed (SLS)
- Safe Direction (SDI)
- Safe Speed Monitor (SSM)

From firmware V6.4 the following additional Safety Integrated Functions are available:

- Basic functions (no additional license is required): SS1E
- Extended functions (an additional license is required): SS2, SS2E, SOS and SLA

Thanks to the high degree of protection IP55 / UL Type 12 and the 3C3 coating on the electronics, the SINAMICS G220 is ready to work in harsh environments ensuring longer lifetimes and rugged operation.

In addition, SINAMICS G220 secures the availability of processes and machines thanks to the support of PROFINET media redundancy protocol and S2 system redundancy.



Example: SINAMICS G220, degree of protection IP55 / UL Type 12, version without a maintenance switch, frame size FSD1

#### **Siemens EcoTech Profile (SEP) for SINAMICS G220**

Siemens introduces a new label: Siemens EcoTech. It is an environmental declaration for products based on product-specific evaluations of sustainability relevant KPIs. To provide maximum transparency, the Siemens EcoTech Profile (SEP) were created for all Siemens EcoTech products.

It is a Siemens-created, standardized product data sheet which gives insight about the product performance in environmental relevant criteria as well as about interpretation and comparison of data against an existing norm, standard or predecessor product.

You can find more information on the internet at:  
<https://support.industry.siemens.com/cs/ww/en/ps/28308/cert?ci=5702>  
[www.siemens.com/SiemensEcoTech](http://www.siemens.com/SiemensEcoTech)



## Overview

### Future-proof your applications by accelerating the digital transformation

SINAMICS G220 is ready for digitalization in every phase of the life cycle: Design – Realize – Optimize.

In the design phase, the **SINAMICS G220 digital twin** integrated in SINAMICS Startdrive commissioning tool in TIA Portal via **DriveSim Engineer** makes it possible to virtualize, simulate and test the drive behavior, identify issues and make changes ahead of time in order to speed up the development of machines and plants.

During the realization phase, our powerful digitalization engineering tools, for example SINAMICS Startdrive commissioning tool in TIA Portal and Drive Connector SINAMICS, speed up the implementation, commissioning and connectivity of SINAMICS G220. Thanks to the IIoT (Industrial Internet of Things) option module together with the edge application Drive Connector SINAMICS, high frequency data can be transferred from the drive to the Industrial Edge and to the cloud. Finally, in the optimization phase, the acquired data can be analyzed on Industrial Edge or in the Cloud for example with the application Drivetrain Analyzer <sup>1)</sup>. The result is improved machine capacity utilization, higher availability, enhanced productivity and optimized energy efficiency.

### Attain a high level of flexibility and seamlessly integrate your solutions globally

SINAMICS G220 offers a high-performance drive solution that can be matched to the customer-specific requirements using the wide range of available option modules and software functions.

- Different option modules can be easily plugged beneath the converter. This allows you to customize the SINAMICS G220 by adding DRIVE-CLiQ interface, ATEX certified sensor temperature connection and the gateway to digitalization via the IIoT module.  
Same flexibility concept applies to the communication of the converter. The communication modules can be simply exchanged to meet the requirements of the standard field-buses. In the first step, PROFINET, Modbus TCP and EtherNet/IP communication protocols are available. PROFIBUS and Modbus RTU will be added to the portfolio soon.
- The SINAMICS Drive Software ensures that SINAMICS G220 frequency converters operate smoothly and reliably. It offers an easy to expand comprehensive software portfolio and enables high flexibility for a wide range of applications. For example, SINAMICS Motor Control Extended for an optimal motor control near standstill, or an extension of the Safety Integrated functions with Safety Extended option.

The SINAMICS G220 is compliant with all the global standards. This frequency converter offers a wide range of power ratings based on a seamlessly integrated system, for all common voltages, line supplies as well as degrees of protection IP20 / UL Open Type and IP55 / UL Type 12.

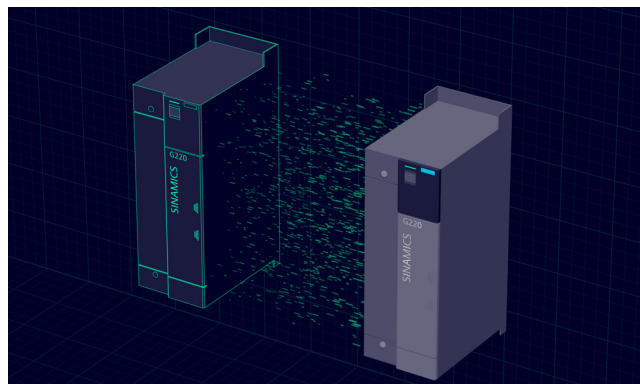

Option Modules



SINAMICS G220 OM-DQ Option Module DRIVE-CLiQ



SINAMICS G220 OM-SMT Option Module Safe Motor Temperature



SINAMICS G220 OM-IIoT Option Module IIoT

<sup>1)</sup> Available soon.

## SINAMICS G220 built-in and wall-mounted units

### Overview

#### Extended warranty

For SINAMICS G220, Siemens offers an optional extended warranty of up to 8 years via **Service Protect**:

- Free for the first 36 months after registering the product at: [www.siemens.com/serviceprotect](http://www.siemens.com/serviceprotect)
- Subject to a charge for a further 3 or 5 years of extended warranty.  
You can find detailed information here: <https://support.industry.siemens.com/cs/ww/en/sc/4842>

You can find the correct Service Protect product number for your SINAMICS G220 converter using our simple configurator [www.siemens.com/serviceprotect](http://www.siemens.com/serviceprotect)

Concerning standard warranty please ask your partner at Siemens.

Your partner can be found in our Personal Contacts Database at: [www.siemens.com/automation-contact](http://www.siemens.com/automation-contact)

### Benefits

- **Reduce energy consumption** with the ultimate Clean Power technology in low harmonics and high efficiency motors control.
- **Protect know-how** and ensure safe personnel, machines and systems with Safety Integrated and Security Integrated.
- **Accelerate time-to-market** by using the digital twin of the drive during design, test and optimization phase.
- **Boost productivity** thanks to easy commissioning, diagnostics, service and the integration into TIA Portal.
- **Safeguard system availability** even in harsh environments thanks to S2 redundancy, IP55 / UL Type 12, ATEX-certified input and Edge and Cloud connectivity.
- **Maximize system flexibility** thanks to a configurable drive solution via hardware and software options.

### Integration

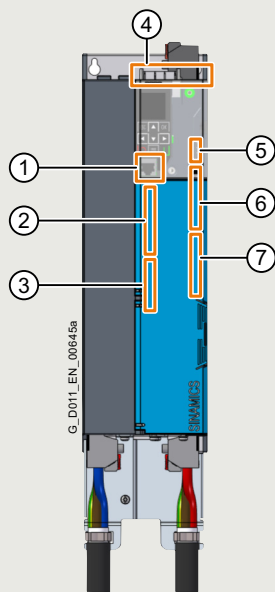

- ① X127 Service interface (e. g. connection for the operation unit)
- ② X132 Analog inputs, analog outputs and temperature sensors
- ③ X133 Digital outputs
- ④ X1xx Communications module
- ⑤ X124 External power supply
- ⑥ X130 Fail-safe digital input, fail-safe digital output
- ⑦ X131 Digital inputs

Example: SINAMICS G220, Interface overview, IP20

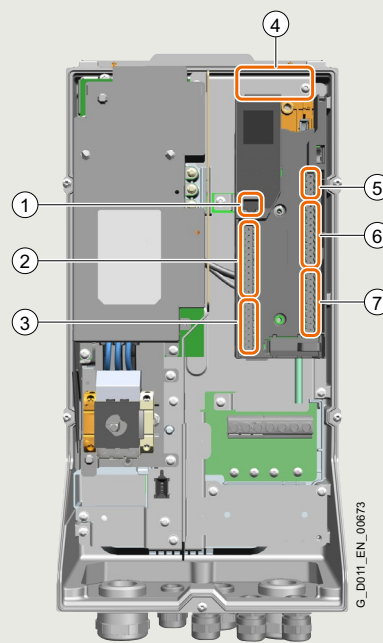

- ① X127 Service interface (e. g. connection for the operation unit)
- ② X132 Analog inputs, analog outputs and temperature sensors
- ③ X133 Digital outputs
- ④ X1xx Communications module
- ⑤ X124 External power supply
- ⑥ X130 Fail-safe digital input, fail-safe digital output
- ⑦ X131 Digital inputs

Example: SINAMICS G220, Interface overview, IP55

# SINAMICS G220 built-in and wall-mounted units

## Integration

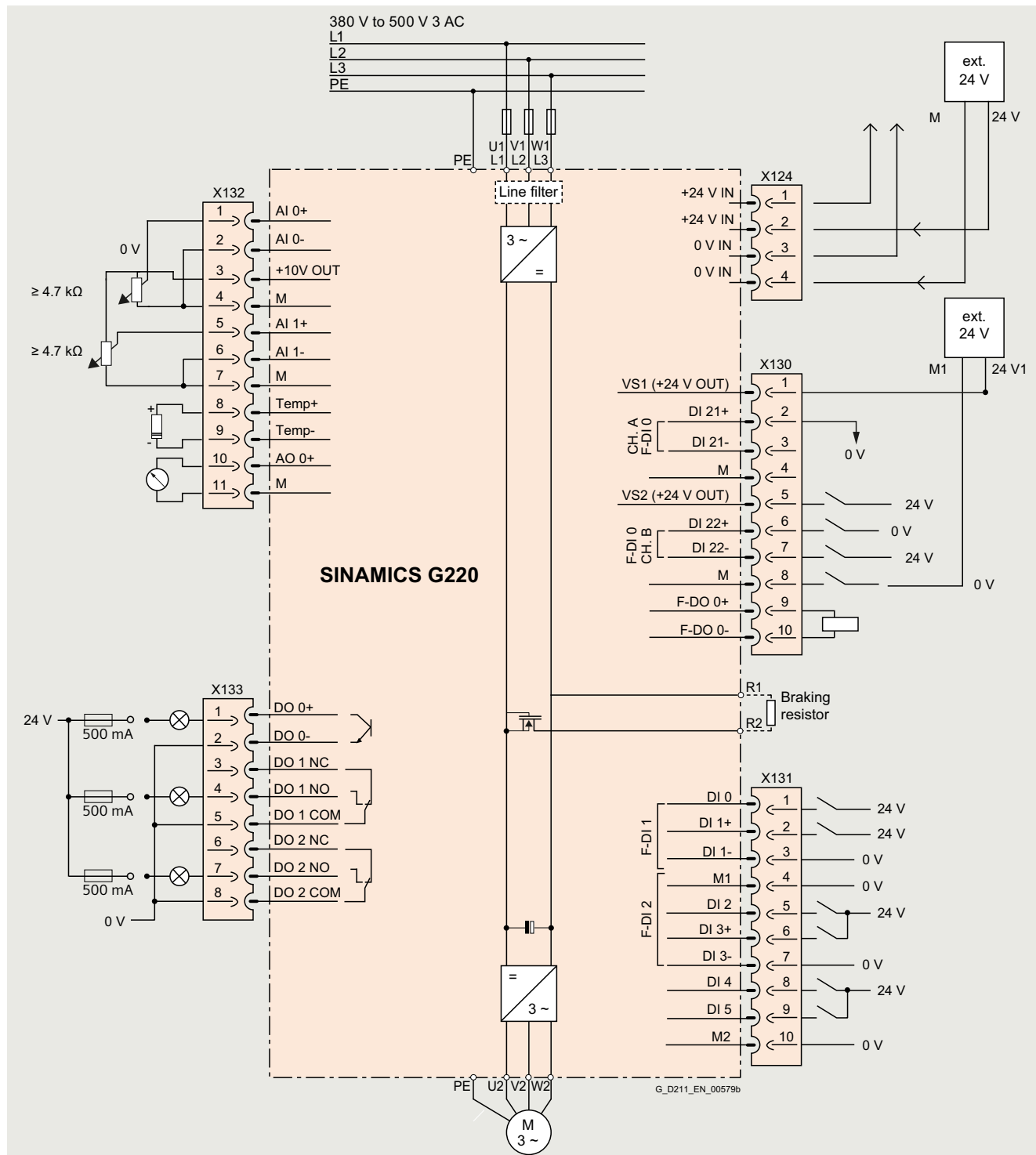

Example: SINAMICS G220, Connection diagram

2



# SINAMICS G220 built-in and wall-mounted units

## Characteristic curves

### Permissible output current depending on pulse frequency



Permissible output current as a function of the pulse frequency, SINAMICS G220, at low overload (LO)

### Permissible output current depending on installation altitude and ambient temperature, SINAMICS G220 degree of protection IP20 / UL Open Type

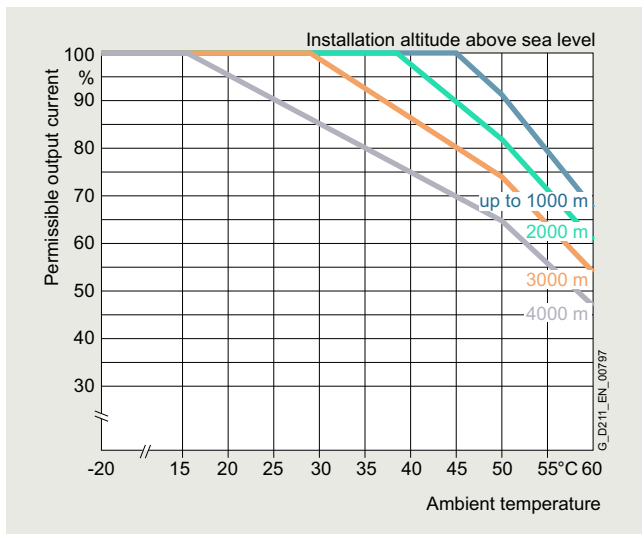

Permissible output current as a function of the installation altitude and the ambient temperature, SINAMICS G220 degree of protection IP20 / UL Open Type, at low overload (LO)

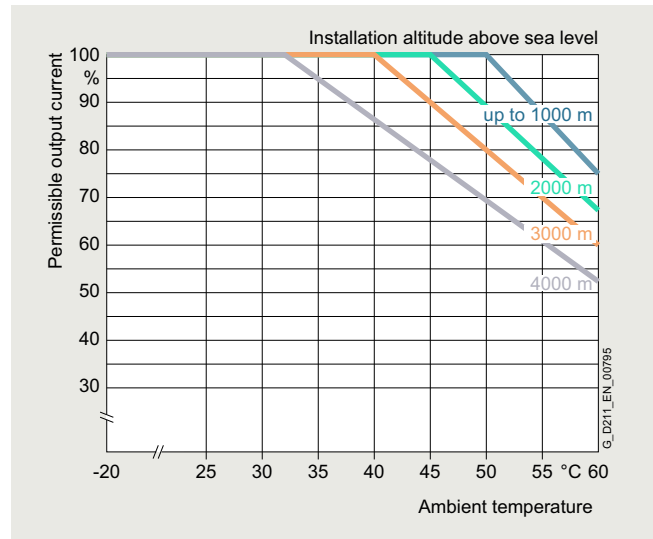

Permissible output current as a function of the installation altitude and the ambient temperature, SINAMICS G220 degree of protection IP20 / UL Open Type, at high overload (HO)

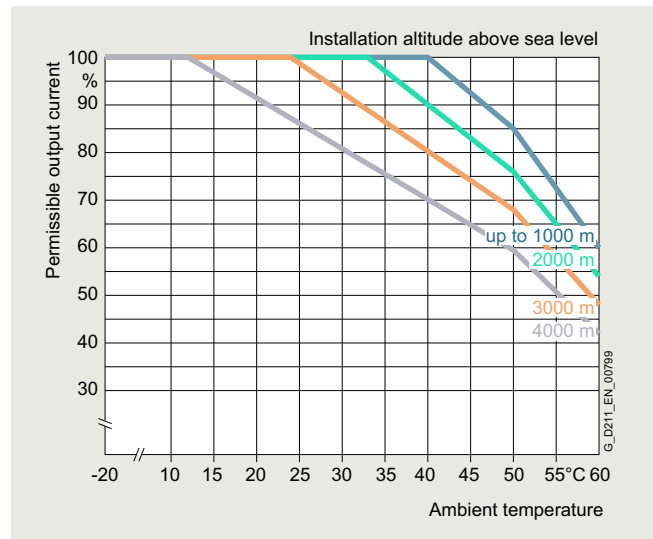

Permissible output current as a function of the installation altitude and the ambient temperature, SINAMICS G220 degree of protection IP20 / UL Open Type, at operation with synchronous reluctance motor

## Characteristic curves

**Permissible output current depending on installation altitude and ambient temperature, SINAMICS G220 degree of protection IP55 / UL Type 12**

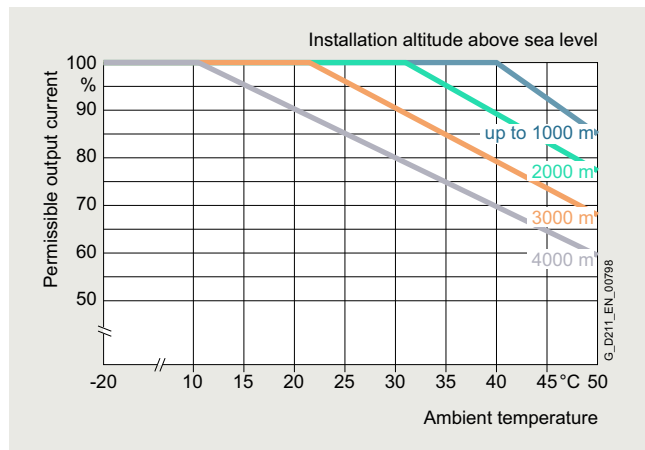

Permissible output current as a function of the installation altitude and the ambient temperature, SINAMICS G220 degree of protection IP55 / UL Type 12, at low overload (LO)

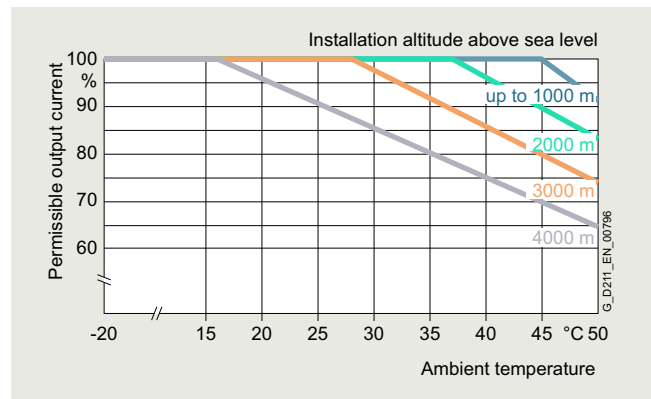

Permissible output current as a function of the installation altitude and the ambient temperature, SINAMICS G220 degree of protection IP55 / UL Type 12, at high overload (HO)

### Notes

Continuous operation above the permissible output current leads to a converter fault due to overtemperature.

The permissible output current in % is the quotient of the permissible output current and the rated output current.

More information on the derating data of SINAMICS G220 is available in the manual on the internet at:

[www.siemens.com/sinamics-g220/documentation](http://www.siemens.com/sinamics-g220/documentation)

## SINAMICS G220 built-in and wall-mounted units

### Dimensional drawings

#### SINAMICS G220 degree of protection IP20 / UL Open Type

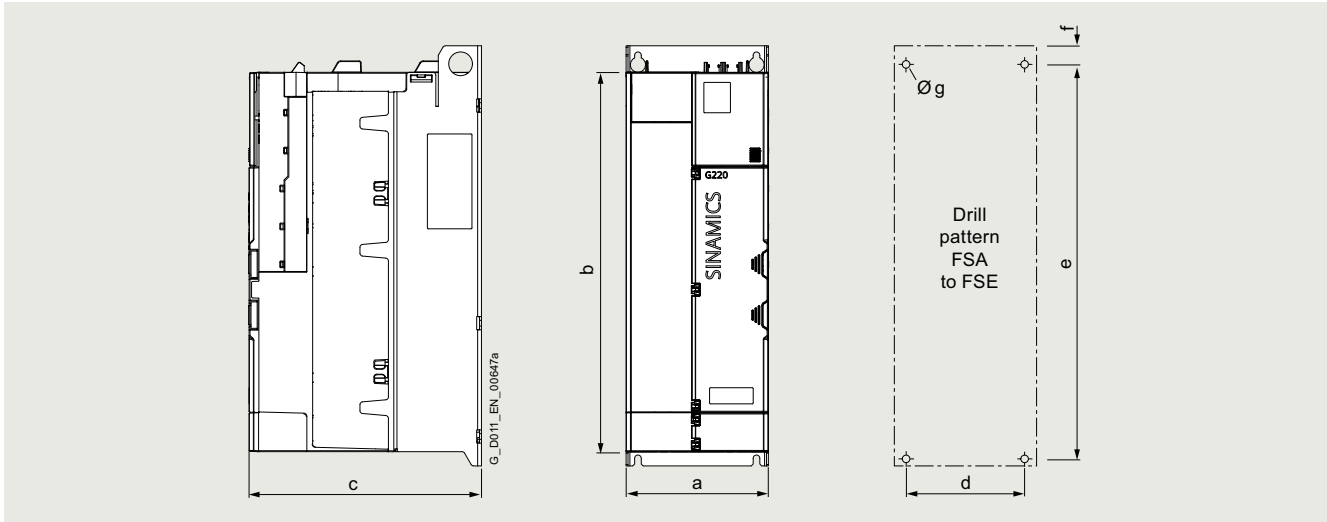

Principle dimension drawing and drill pattern for SINAMICS G220 degree of protection IP20 / UL Open Type

Frame size	Dimensions in mm (inches)			Drilling dimensions in mm (inches)				Mounting With screws (plus washers and nuts)	Cooling clearance in mm (inches)		Minimal mounting clearance (inches) front
	a (width)	b (height) <sup>1)</sup>	c (depth)	d	e	f	g		top	bottom	
FSA	73 (2.88)	250 (9.84)	208 (8.19)	50 (1.97)	275 (10.83)	10 (0.39)	11 (0.43)	4 × M4	85 (3.35)	85 (3.35)	10 (0.39)
FSB	85 (3.35)	355 (13.98)	208 (8.19)	50 (1.97)	375 (14.76)	8.7 (0.34)	11 (0.43)	4 × M5	85 (3.35)	108 (4.26)	10 (0.39)
FSC	125 (4.92)	355 (13.98)	209 (8.23)	100 (3.94)	375 (14.76)	10 (0.39)	11.5 (0.45)	4 × M5	85 (3.35)	149 (5.87)	10 (0.39)
FSD1	150 (5.91)	400 (15.75)	245 (9.65)	125 (4.92)	425 (16.73)	10 (0.39)	16 (0.63)	4 × M6	90 (3.55)	160 (6.30)	10 (0.39)
FSD2	200 (7.87)	442 (17.41)	245 (9.65)	175 (6.89)	475 (18.70)	10 (0.39)	16 (0.63)	4 × M6	90 (3.55)	160 (6.30)	10 (0.39)
FSE	250 (9.84)	520 (20.47)	245 (9.65)	225 (8.86)	550 (21.66)	10 (0.39)	16 (0.63)	4 × M6	90 (3.55)	193 (7.60)	10 (0.39)

<sup>1)</sup> Height is extended by the shield plate – refer to the equipment user manual for specific values.

## Dimensional drawings

## SINAMICS G220 degree of protection IP55 / UL Type 12

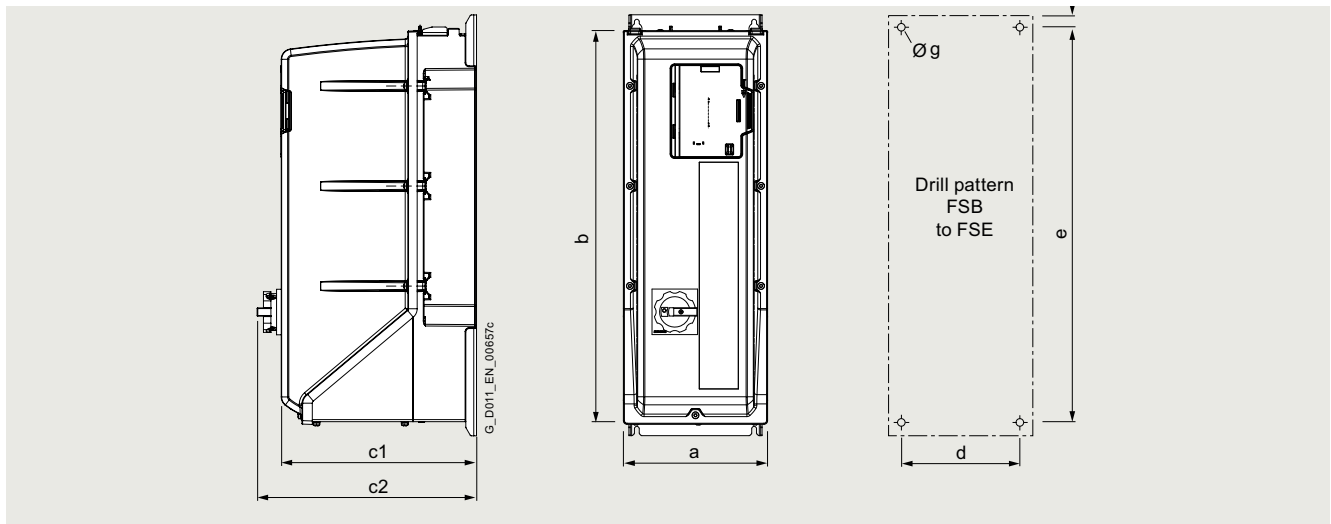

Principle dimension drawing and drill pattern for SINAMICS G220 degree of protection IP55 / UL Type 12

Frame size	Dimensions in mm (inches)				Drilling dimensions in mm (inches)				Mounting (plus washers and nuts)	Cooling clearance in mm (inches)	
	a (width)	b (height)	c1 (depth)	c2 (depth)	d	e	f	g		top	bottom
FSB	225 (8.87)	415 (16.35)	225 (8.86)	265 (10.43)	170 (6.70)	435 (17.14)	8 (0.32)	13 (0.51)	4 × M4	103 (4.06)	103 (4.06)
FSC	245 (9.65)	460 (18.12)	250 (9.84)	283 (11.14)	200 (7.88)	480 (18.91)	10 (0.39)	16 (0.63)	4 × M5	115 (4.53)	115 (4.53)
FSD1	209 (8.23)	571 (22.50)	284 (11.18)	319 (12.56)	170 (6.70)	590 (23.25)	10 (0.39)	15 (0.59)	4 × M5	143 (5.63)	143 (5.63)
FSD2	270 (10.64)	650 (25.61)	284 (11.18)	318 (12.52)	225 (8.87)	675 (26.60)	14 (0.55)	14 (0.55)	4 × M6	163 (6.42)	163 (6.42)
FSE	327 (12.88)	778 (30.65)	315 (12.40)	379 (14.92)	285 (11.23)	800 (31.54)	14 (0.55)	14 (0.55)	4 × M6	195 (7.68)	195 (7.68)

# SINAMICS G220 built-in and wall-mounted units

Clicking to SiePortal

6SL3255-0AA00-5AA0



IP20/UL Open Type · 200 ... 240 V 3 AC · 0.55 kW to 30 kW (0.75 hp to 40 hp)

## Selection and ordering data

SINAMICS G220 built-in and wall-mounted units → Configuration with power components (see right page)

Rated power				Rated output current				Rated input current		Frame size	SINAMICS G220 without integrated line filter
Low overload (LO)		High overload (HO)		Low overload (LO)		High overload (HO)		Low overload (LO)			
Acc. to IEC	Acc. to NEC	Acc. to IEC	Acc. to NEC	Acc. to IEC	Acc. to NEC	Acc. to IEC	Acc. to NEC	Acc. to IEC	Acc. to NEC		
230 V	240 V	230 V	240 V	230 V	240 V	230 V	240 V	230 V	240 V		
kW	hp	kW	hp	A	A	A	A	A	A	Article No.	

200 ... 240 V 3 AC · Rated pulse frequency 4 kHz · Input frequency 50/60 Hz (47 ... 63 Hz)

0.55	0.75	0.37	0.5	3.9	3.2	2.9	2.2	3.2	3.0	FSA	6SL4112-0 ■ A 05 - 0 ■ F 0
0.75	1	0.55	0.75	4.7	4.2	3.9	3.2	3.9	3.7	FSA	6SL4112-0 ■ A 06 - 0 ■ F 0
1.1	1.5	0.75	1	6.5	6.0	4.7	4.2	5.4	5.1	FSA	6SL4112-0 ■ A 08 - 0 ■ F 0
1.5	2	1.1	1.5	8.5	6.8	6.5	6.0	7.1	6.4	FSA	6SL4112-0 ■ A 10 - 0 ■ F 0
2.2	3	1.5	2	11	9.6	8.5	6.8	10.1	9.3	FSA	6SL4112-0 ■ A 11 - 0 ■ F 0
3	4	2.2	3	14.5	12.4	11	9.6	13.1	11.9	FSB	6SL4112-0 ■ A 12 - 0 ■ F 0
4	5	3	4	19	15.2	14.5	12.4	17.7	14.7	FSB	6SL4112-0 ■ A 13 - 0 ■ F 0
5.5	7.5	4	5	27	22	19	15.2	21.7	20.1	FSC	6SL4112-0 ■ A 15 - 0 ■ F 0
7.5	10	5.5	7.5	34	28	27	22	29.5	26.6	FSC	6SL4112-0 ■ A 16 - 0 ■ F 0
11	15	7.5	10	46	42	40	28	41.8	39.5	FSD2	6SL4112-0 ■ A 17 - 0 ■ F 0
15	20	11	15	63	54	46	42	53.9	49.7	FSD2	6SL4112-0 ■ A 18 - 0 ■ F 0
18.5	25	15	20	75	68	63	54	66.5	62.5	FSD2	6SL4112-0 ■ A 20 - 0 ■ F 0
22	30	18.5	25	90	80	75	68	76.0	72.1	FSE	6SL4112-0 ■ A 21 - 0 ■ F 0
30	40	22	30	112	104	90	80	103.2	96.1	FSE	6SL4112-0 ■ A 23 - 0 ■ F 0

### Article No. supplements

Degree of protection	Cooling	Coating acc. to IEC 60721-3-3: 2002	Housing							
IP20/UL Open Type	Internal	Class 3C2 Class 3C3	Standard							
<b>Hardware configuration</b>										
Standard										
<b>Line filter</b>										
Without integrated line filter										
<b>Additional hardware option</b>										
Without hardware option or with more than one hardware option (see Special versions)										
OM-DQ Option Module DRIVE-CLiQ										
OM-ILoT Option Module ILoT										
OM-SMT Option Module Safe Motor Temperature										
<b>Communication</b>										
PROFINET, Modbus TCP and EtherNet/IP										
<b>Special versions</b>										
Only for selection of more than one hardware option (Additional hardware option = "A")										
6SL4112-0 ■ ... - A . 0 - Z...+...+...										
OM-DQ Option Module DRIVE-CLiQ										
OM-ILoT Option Module ILoT										
OM-SMT Option Module Safe Motor Temperature										
Order codes										
T01										
T04										
T05										

### More information

Further technical specifications and documentation are available on the internet at:

[www.siemens.com/sinamics-g220/documentation](http://www.siemens.com/sinamics-g220/documentation)

and concerning ordering and configuration via the Siemens Product Configurator in SiePortal:

[www.siemens.com/sinamics-g220/configuration](http://www.siemens.com/sinamics-g220/configuration)



Clicking to SiePortal

6SL3255-0AA00-5AA0



# SINAMICS G220 built-in and wall-mounted units

IP20/UL Open Type · 200 ... 240 V 3 AC · 0.55 kW to 30 kW (0.75 hp to 40 hp)

Line-side components					DC link components	Load-side power components		
Line reactors	Recommended line-side overcurrent protection devices				Braking resistors	Output reactors	dv/dt filters plus VPL	
	More information at: <a href="http://www.siemens.com/sinamics-g220/ocpd">www.siemens.com/sinamics-g220/ocpd</a>							
	Fuses IEC-compliant		Fuses UL/cUL-compliant Rated voltage 600 V AC					
	Current		Fuse type	Current				
Article No.	A	Article No.	Class/Article No.	A	Article No.	Article No.	Article No.	
A DC line reactor is integrated – therefore no line reactor is required.	6	3NA3801	J	6	JJY:023151720007	–	–	
	10	3NA3803	J	8		–	–	
	10	3NA3803	J	10		–	–	
	16	3NA3805	J	12		–	–	
	16	3NA3805	J	15		–	–	
	20	3NA3807	J	20	JJY:023163720018	–	–	
	32	3NA3812	J	30		–	–	
	40	3NA3817	J	40	JJY:023433720001	–	–	
	50	3NA3820	J	50		–	–	
	80	3NA3824	J	70	JJY:023422620002	–	–	
	100	3NA3830	J	90		–	–	
	100	3NA3830	J	110		–	–	
	125	3NA3832	J	125	JJY:023423320001	–	–	
160	3NA3836	J	150		–	–		

### Ordering examples

Basic selection				Example 1				Example 2			
<b>SINAMICS G220 converters · degree of protection IP20/UL Open Type · 200 ... 240 V 3 AC, 15 kW · without integrated line filter</b>				6SL4112-0 C A 18- 0 A F 0 -Z				6SL4112-0 D A 18- 0 B F 0			
<b>Article No. supplements</b>											
<b>Degree of protection</b>	<b>Cooling</b>	<b>Coating</b> acc. to IEC 60721-3-3: 2002	<b>Housing</b>								
IP20/UL Open Type	Internal	Class 3C2 Class 3C3	Standard	C				D			
<b>Hardware configuration</b>											
Standard											
<b>Line filter</b>											
Without integrated line filter											
<b>Additional hardware option</b>											
Without hardware option or with more than one hardware option (see Special versions)											
OM-DQ Option Module DRIVE-CLiQ											
OM-ILoT Option Module ILoT											
OM-SMT Option Module Safe Motor Temperature											
<b>Communication</b>											
PROFINET, Modbus TCP and EtherNet/IP											
<b>Special versions</b>											
OM-DQ Option Module DRIVE-CLiQ											
OM-ILoT Option Module ILoT											
OM-SMT Option Module Safe Motor Temperature											
<b>Complete Article No.</b>											
with "-Z" and order codes				6SL4112-0 C A 18- 0 A F 0 -Z				6SL4112-0 D A 18- 0 B F 0			
				T01 T04 T05				T01 + T04 + T05			

2

# SINAMICS G220 built-in and wall-mounted units

Clicking to SiePortal

6SL3255-0AA00-5AA0



IP20/UL Open Type · 380 ... 500 V 3 AC · 1.1 kW to 55 kW (1.5 hp to 75 hp)

## Selection and ordering data

SINAMICS G220 built-in and wall-mounted units → Configuration with power components (see right page)

Rated power		Rated output current				Rated input current		Frame size	SINAMICS G220 without integrated line filter	SINAMICS G220 with integrated line filter		
Low overload (LO)		High overload (HO)		Low overload (LO)		High overload (HO)		Low overload (LO)				
Acc. to IEC	Acc. to NEC	Acc. to IEC	Acc. to NEC	Acc. to IEC	Acc. to NEC	Acc. to IEC	Acc. to NEC	Acc. to IEC	Acc. to NEC	Article No.		
400 V	480 V	400 V	480 V	400 V	480 V	400 V	480 V	400 V	480 V	Article No.		
kW	hp	kW	hp	A	A	A	A	A	A			
<b>380 ... 500 V 3 AC · Rated pulse frequency 4 kHz · Input frequency 50/60 Hz (47 ... 63 Hz)</b>												
1.1	1.5	0.75	1	3.9	3.0	2.9	2.1	3.3	3.0	FSA	6SL4113-0 ■ A 08 - 0 ■ F 0	6SL4113-0 ■ A 08 - 2 ■ F 0
1.5	2	1.1	1.5	4.7	3.4	3.9	3.0	4.1	3.7	FSA	6SL4113-0 ■ A 10 - 0 ■ F 0	6SL4113-0 ■ A 10 - 2 ■ F 0
2.2	3	1.5	2	6.5	4.8	4.7	3.4	5.6	4.9	FSA	6SL4113-0 ■ A 11 - 0 ■ F 0	6SL4113-0 ■ A 11 - 2 ■ F 0
3	4	2.2	3	8.5	6.2	6.5	4.8	7.3	6.1	FSA	6SL4113-0 ■ A 12 - 0 ■ F 0	6SL4113-0 ■ A 12 - 2 ■ F 0
4	5	3	4	11	7.6	8.5	6.2	9.6	7.3	FSA	6SL4113-0 ■ A 13 - 0 ■ F 0	6SL4113-0 ■ A 13 - 2 ■ F 0
5.5	7.5	4	5	14.5	11	11	7.6	12.9	11.0	FSB	6SL4113-0 ■ A 15 - 0 ■ F 0	6SL4113-0 ■ A 15 - 2 ■ F 0
7.5	10	5.5	7.5	19	14	14.5	11	17.3	14.0	FSB	6SL4113-0 ■ A 16 - 0 ■ F 0	6SL4113-0 ■ A 16 - 2 ■ F 0
11	15	7.5	10	27	21	19	14	23.3	19.6	FSC	6SL4113-0 ■ A 17 - 0 ■ F 0	6SL4113-0 ■ A 17 - 2 ■ F 0
15	20	11	15	34	27	27	21	31.3	25.4	FSC	6SL4113-0 ■ A 18 - 0 ■ F 0	6SL4113-0 ■ A 18 - 2 ■ F 0
18.5	25	15	20	40	34	34	27	37.8	31.6	FSD1	6SL4113-0 ■ A 20 - 0 ■ F 0	6SL4113-0 ■ A 20 - 2 ■ F 0
22	30	18.5	25	46	40	40	34	44.9	37.5	FSD1	6SL4113-0 ■ A 21 - 0 ■ F 0	6SL4113-0 ■ A 21 - 2 ■ F 0
30	40	22	30	63	52	46	40	59.9	49.8	FSD2	6SL4113-0 ■ A 23 - 0 ■ F 0	6SL4113-0 ■ A 23 - 2 ■ F 0
37	50	30	40	75	65	63	52	72.6	59.9	FSD2	6SL4113-0 ■ A 24 - 0 ■ F 0	6SL4113-0 ■ A 24 - 2 ■ F 0
45	60	37	50	90	77	75	65	86.7	71.3	FSE	6SL4113-0 ■ A 26 - 0 ■ F 0	6SL4113-0 ■ A 26 - 2 ■ F 0
55	75	45	60	112	96	90	77	105.9	88.3	FSE	6SL4113-0 ■ A 27 - 0 ■ F 0	6SL4113-0 ■ A 27 - 2 ■ F 0

### Article No. supplements

Degree of protection	Cooling	Coating acc. to IEC 60721-3-3: 2002	Housing	Order codes	
IP20/UL Open Type	Internal	Class 3C2 Class 3C3	Standard	C D	C D
<b>Hardware configuration</b>				A	A
Standard				A	A
<b>Line filter</b>				0	2
Without integrated line filter				0	2
With integrated line filter Category C2				0	2
<b>Additional hardware option</b>				A B E F	A B E F
Without hardware option or with more than one hardware option (see Special versions)				A B E F	A B E F
OM-DQ Option Module DRIVE-CLiQ				A	A
OM-IIoT Option Module IIoT				B	B
OM-SMT Option Module Safe Motor Temperature				E	E
<b>Communication</b>				F	F
PROFINET, Modbus TCP and EtherNet/IP				F	F
<b>Special versions</b>					
Only for selection of more than one hardware option (Additional hardware option = "A")				6SL4113-0 ■ ... - . A . 0	-Z...+...+...
OM-DQ Option Module DRIVE-CLiQ				T01	T01
OM-IIoT Option Module IIoT				T04	T04
OM-SMT Option Module Safe Motor Temperature				T05	T05

### More information

Further technical specifications and documentation are available on the internet at:  
[www.siemens.com/sinamics-g220/documentation](http://www.siemens.com/sinamics-g220/documentation)

and concerning ordering and configuration via the Siemens Product Configurator in SiePortal:  
[www.siemens.com/sinamics-g220/configuration](http://www.siemens.com/sinamics-g220/configuration)

Clicking to SiePortal

6SL3255-0AA00-5AA0



## SINAMICS G220 built-in and wall-mounted units

IP20/UL Open Type · 380 ... 500 V 3 AC · 1.1 kW to 55 kW (1.5 hp to 75 hp)

Line-side components					DC link components	Load-side power components	
Line reactors	Recommended line-side overcurrent protection devices				Braking resistors	Output reactors	dv/dt filters plus VPL
	More information at: <a href="http://www.siemens.com/sinamics-g220/ocpd">www.siemens.com/sinamics-g220/ocpd</a> Fuses IEC-compliant      Fuses UL/cUL-compliant Rated voltage 600 V AC						
Article No.	Current A	Article No.	Fuse type Class/Article No.	Current A	Article No.	Article No.	Article No.
A DC line reactor is integrated – therefore no line reactor is required.	6	<b>3NA3801</b>	J	6	<b>6SL3201-0BE14-3AA0</b>	–	available soon
	10	<b>3NA3803</b>	J	8		–	available soon
	10	<b>3NA3803</b>	J	10	<b>6SL3201-0BE21-0AA0</b>	–	available soon
	16	<b>3NA3805</b>	J	12		–	available soon
	16	<b>3NA3805</b>	J	15		–	available soon
	20	<b>3NA3807</b>	J	20	<b>6SL3201-0BE21-8AA0</b>	–	available soon
	32	<b>3NA3812</b>	J	30		–	available soon
	40	<b>3NA3817</b>	J	40	<b>6SL3201-0BE23-8AA0</b>	–	available soon
	50	<b>3NA3820</b>	J	50		–	available soon
	63	<b>3NA3822</b>	J	60	<b>JJY:023422620001</b>	–	available soon
	80	<b>3NA3824</b>	J	70		–	available soon
	100	<b>3NA3830</b>	J	90	<b>JJY:023424020001</b>	–	available soon
	100	<b>3NA3830</b>	J	110		–	available soon
	120	<b>3NA3832</b>	J	125	<b>JJY:023434020001</b>	–	available soon
160	<b>3NA3836</b>	J	150		–	available soon	

2

# SINAMICS G220 built-in and wall-mounted units

Clicking to SiePortal

6SL3255-0AA00-5AA0



IP55/UL Type 12 · 200 ... 240 V 3 AC · 1.1 kW to 30 kW (1.5 hp to 40 hp)

## Selection and ordering data

SINAMICS G220 built-in and wall-mounted units → Configuration with power components (see right page)

Rated power				Rated output current				Rated input current		Frame size	SINAMICS G220 without integrated line filter
Low overload (LO)		High overload (HO)		Low overload (LO)		High overload (HO)		Low overload (LO)			
Acc. to IEC	Acc. to NEC	Acc. to IEC	Acc. to NEC	Acc. to IEC	Acc. to NEC	Acc. to IEC	Acc. to NEC	Acc. to IEC	Acc. to NEC		
230 V	240 V	230 V	240 V	230 V	240 V	230 V	240 V	230 V	240 V		
kW	hp	kW	hp	A	A	A	A	A	A	Article No.	

200 ... 240 V 3 AC · Rated pulse frequency 4 kHz · Input frequency 50/60 Hz (47 ... 63 Hz)

1.1	1.5	0.75	1	6.5	6	4.7	4.2	5.4	5.1	FSB	6SL4112-0 ■ 08 - 0 ■ F 0
1.5	2	1.1	1.5	8.5	6.8	6.5	6	7.1	6.4	FSB	6SL4112-0 ■ 10 - 0 ■ F 0
2.2	3	1.5	2	11	9.6	8.5	6.8	10.1	9.3	FSB	6SL4112-0 ■ 11 - 0 ■ F 0
3	4	2.2	3	14.5	12.4	11	9.6	13.1	11.9	FSB	6SL4112-0 ■ 12 - 0 ■ F 0
4	5	3	4	19	15.2	14.5	12.4	17.7	14.7	FSB	6SL4112-0 ■ 13 - 0 ■ F 0
5.5	7.5	4	5	27	22	19	15.2	21.7	20.1	FSC	6SL4112-0 ■ 15 - 0 ■ F 0
7.5	10	5.5	7.5	34	28	27	22	29.5	26.6	FSC	6SL4112-0 ■ 16 - 0 ■ F 0
11	15	7.5	10	46	42	40	28	41.8	39.5	FSD2	6SL4112-0 ■ 17 - 0 ■ F 0
15	20	11	15	63	54	46	42	53.9	49.7	FSD2	6SL4112-0 ■ 18 - 0 ■ F 0
18.5	25	15	20	75	68	63	54	66.5	62.5	FSD2	6SL4112-0 ■ 20 - 0 ■ F 0
22	30	18.5	25	90	80	75	68	76.0	72.1	FSE	6SL4112-0 ■ 21 - 0 ■ F 0
30	40	22	30	112	104	90	80	103.2	96.1	FSE	6SL4112-0 ■ 23 - 0 ■ F 0

### Article No. supplements

Degree of protection	Cooling	Coating acc. to IEC 60721-3-3: 2002	Housing							
IP55/UL Type 12	Internal	Class 3C2	Standard	J						
		Class 3C3	Maintenance switch <sup>1)</sup>	L						
			Standard	K						
			Maintenance switch <sup>1)</sup>	M						
<b>Hardware configurations</b>										
Standard										
Gland plate for connecting in IP55 degree of protection according to IEC										
Gland plate for connecting in UL Type 12 degree of protection										
<b>Line filter</b>										
Without integrated line filter										
<b>Additional hardware option</b>										
Without hardware option or with more than one hardware option (see Special versions)										
OM-DQ Option Module DRIVE-CLiQ										
OM-IIoT Option Module IIoT										
OM-SMT Option Module Safe Motor Temperature										
<b>Communication</b>										
PROFINET, Modbus TCP and EtherNet/IP										
<b>Special versions</b>										
Only for selection of more than one hardware option (Additional hardware option = "A")										
6SL4112-0 ■ . . . - A . 0 - Z . . . + . . . + . . .										
OM-DQ Option Module DRIVE-CLiQ										
OM-IIoT Option Module IIoT										
OM-SMT Option Module Safe Motor Temperature										
Order codes										
T01										
T04										
T05										

### More information

Further technical specifications and documentation are available on the internet at:  
[www.siemens.com/sinamics-g220/documentation](http://www.siemens.com/sinamics-g220/documentation)  
 and concerning ordering and configuration via the Siemens Product Configurator in SiePortal:  
[www.siemens.com/sinamics-g220/configuration](http://www.siemens.com/sinamics-g220/configuration)

<sup>1)</sup> Available soon.

Clicking to SiePortal

GSL3255-0AA00-5AA0



## SINAMICS G220 built-in and wall-mounted units

IP55/UL Type 12 · 200 ... 240 V 3 AC · 1.1 kW to 30 kW (1.5 hp to 40 hp)

Line-side components					DC link components	Load-side power components	
Line reactors	Recommended line-side overcurrent protection devices				Braking resistors	Output reactors	dv/dt filters plus VPL
	More information at: <a href="http://www.siemens.com/sinamics-g220/ocpd">www.siemens.com/sinamics-g220/ocpd</a>				Degree of protection IP54		
	Fuses IEC-compliant		Fuses UL/cUL-compliant Rated voltage 600 V AC				
	Current		Fuse type	Current			
Article No.	A	Article No.	Class/Article No.	A	Article No.	Article No.	Article No.
A DC line reactor is integrated – therefore no line reactor is required.	10	<b>3NA3803</b>	J	10	–	–	–
	16	<b>3NA3805</b>	J	12	–	–	–
	16	<b>3NA3805</b>	J	15	–	–	–
	20	<b>3NA3807</b>	J	20	–	–	–
	32	<b>3NA3812</b>	J	30	–	–	–
	40	<b>3NA3817</b>	J	40	–	–	–
	50	<b>3NA3820</b>	J	50	–	–	–
	80	<b>3NA3824</b>	J	70	–	–	–
	100	<b>3NA3830</b>	J	90	–	–	–
	100	<b>3NA3830</b>	J	110	–	–	–
	125	<b>3NA3832</b>	J	125	–	–	–
	160	<b>3NA3836</b>	J	150	–	–	–

2



# SINAMICS G220 built-in and wall-mounted units

Clicking to SiePortal

6SL3255-0AA00-5AA0



IP55/UL Type 12 · 380 ... 500 V 3 AC · 1.1 kW to 55 kW (1.5 hp to 75 hp)

## Selection and ordering data

SINAMICS G220 built-in and wall-mounted units → Configuration with power components (see right page)

Rated power		Rated output current				Rated input current		Frame size	SINAMICS G220 without integrated line filter	SINAMICS G220 with integrated line filter		
Low overload (LO)		High overload (HO)		Low overload (LO)		High overload (HO)		Low overload (LO)				
Acc. to IEC	Acc. to NEC	Acc. to IEC	Acc. to NEC	Acc. to IEC	Acc. to NEC	Acc. to IEC	Acc. to NEC	Acc. to IEC	Acc. to NEC	Article No.		
400 V	480 V	400 V	480 V	400 V	480 V	400 V	480 V	400 V	480 V	Article No.		
kW	hp	kW	hp	A	A	A	A	A	A			
<b>380 ... 500 V 3 AC · Rated pulse frequency 4 kHz · Input frequency 50/60 Hz (47 ... 63 Hz)</b>												
1.1	1.5	0.75	1	3.9	3	2.9	2.1	3.3	3.0	FSB	6SL4113-0 ■ ■ 08 - 0 ■ F 0	6SL4113-0 ■ ■ 08 - 2 ■ F 0
1.5	2	1.1	1.5	4.7	3.4	3.9	3	4.1	3.7	FSB	6SL4113-0 ■ ■ 10 - 0 ■ F 0	6SL4113-0 ■ ■ 10 - 2 ■ F 0
2.2	3	1.5	2	6.5	4.8	4.7	3.4	5.6	4.9	FSB	6SL4113-0 ■ ■ 11 - 0 ■ F 0	6SL4113-0 ■ ■ 11 - 2 ■ F 0
3	4	2.2	3	8.5	6.2	6.5	4.8	7.3	6.1	FSB	6SL4113-0 ■ ■ 12 - 0 ■ F 0	6SL4113-0 ■ ■ 12 - 2 ■ F 0
4	5	3	4	11	7.6	8.5	6.2	9.6	7.3	FSB	6SL4113-0 ■ ■ 13 - 0 ■ F 0	6SL4113-0 ■ ■ 13 - 2 ■ F 0
5.5	7.5	4	5	14.5	11	11	7.6	12.9	11.0	FSB	6SL4113-0 ■ ■ 15 - 0 ■ F 0	6SL4113-0 ■ ■ 15 - 2 ■ F 0
7.5	10	5.5	7.5	19	14	14.5	11	17.3	14.0	FSB	6SL4113-0 ■ ■ 16 - 0 ■ F 0	6SL4113-0 ■ ■ 16 - 2 ■ F 0
11	15	7.5	10	27	21	19	14	23.3	19.6	FSC	6SL4113-0 ■ ■ 17 - 0 ■ F 0	6SL4113-0 ■ ■ 17 - 2 ■ F 0
15	20	11.0	15	34	27	27	21	31.3	25.4	FSC	6SL4113-0 ■ ■ 18 - 0 ■ F 0	6SL4113-0 ■ ■ 18 - 2 ■ F 0
18.5	25	15.0	20	40	34	34	27	37.8	31.6	FSD1	6SL4113-0 ■ ■ 20 - 0 ■ F 0	6SL4113-0 ■ ■ 20 - 2 ■ F 0
22	30	18.5	25	46	40	40	34	44.9	37.5	FSD1	6SL4113-0 ■ ■ 21 - 0 ■ F 0	6SL4113-0 ■ ■ 21 - 2 ■ F 0
30	40	22.0	30	63	52	46	40	59.9	49.8	FSD2	6SL4113-0 ■ ■ 23 - 0 ■ F 0	6SL4113-0 ■ ■ 23 - 2 ■ F 0
37	50	30	40	75	65	63	52	72.6	59.9	FSD2	6SL4113-0 ■ ■ 24 - 0 ■ F 0	6SL4113-0 ■ ■ 24 - 2 ■ F 0
45	60	37	50	90	77	75	65	86.7	71.3	FSE	6SL4113-0 ■ ■ 26 - 0 ■ F 0	6SL4113-0 ■ ■ 26 - 2 ■ F 0
55	75	45	60	112	96	90	77	105.9	88.3	FSE	6SL4113-0 ■ ■ 27 - 0 ■ F 0	6SL4113-0 ■ ■ 27 - 2 ■ F 0

### Article No. supplements

Degree of protection	Cooling	Coating acc. to IEC 60721-3-3: 2002	Housing	J	L	K	M	A	P	Q	0	2	A	B	E	F	F	F	
IP55/UL Type 12	Internal	Class 3C2	Standard																
		Class 3C3	Maintenance switch <sup>1)</sup>																
			Standard																
			Maintenance switch <sup>1)</sup>																
<b>Hardware configurations</b>																			
Standard																			
Gland plate for connecting in IP55 degree of protection according to IEC																			
Gland plate for connecting in UL Type 12 degree of protection																			
<b>Line filter</b>																			
Without integrated line filter																			
With integrated line filter Category C2																			
<b>Additional hardware option</b>																			
Without hardware option or with more than one hardware option (see Special versions)																			
OM-DQ Option Module DRIVE-CLiQ																			
OM-IloT Option Module IloT																			
OM-SMT Option Module Safe Motor Temperature																			
<b>Communication</b>																			
PROFINET, Modbus TCP and EtherNet/IP																			
<b>Special versions</b>																			
Only for selection of more than one hardware option (Additional hardware option = "A")																			
6SL4113-0 ■ ... - A 0																			
Order codes																			
-Z...+...+...																			
OM-DQ Option Module DRIVE-CLiQ																			
OM-IloT Option Module IloT																			
OM-SMT Option Module Safe Motor Temperature																			
T01																			
T04																			
T05																			

### More information

Further technical specifications and documentation are available on the internet at:  
[www.siemens.com/sinamics-g220/documentation](http://www.siemens.com/sinamics-g220/documentation)

and concerning ordering and configuration via the Siemens Product Configurator in SiePortal:  
[www.siemens.com/sinamics-g220/configuration](http://www.siemens.com/sinamics-g220/configuration)

<sup>1)</sup> Available soon.

Clicking to SiePortal

6SL3255-0AA00-5AA0



## SINAMICS G220 built-in and wall-mounted units

IP55/UL Type 12 · 380 ... 500 V 3 AC · 1.1 kW to 55 kW (1.5 hp to 75 hp)

Line-side components					DC link components	Load-side power components	
Line reactors	Recommended line-side overcurrent protection devices				Braking resistors	Output reactors	dv/dt filters plus VPL
	More information at: <a href="http://www.siemens.com/sinamics-g220/ocpd">www.siemens.com/sinamics-g220/ocpd</a>				Degree of protection IP54		
	Fuses IEC-compliant	Fuses UL/cUL-compliant Rated voltage 600 V AC					
	Current		Fuse type	Current			
Article No.	A	Article No.	Class/Article No.	A	Article No.	Article No.	Article No.
A DC line reactor is integrated – therefore no line reactor is required.	6	<b>3NA3801</b>	J	6	–	–	–
	10	<b>3NA3803</b>	J	8	–	–	–
	10	<b>3NA3803</b>	J	10	–	–	–
	16	<b>3NA3805</b>	J	12	–	–	–
	16	<b>3NA3805</b>	J	15	–	–	–
	20	<b>3NA3807</b>	J	20	–	–	–
	32	<b>3NA3812</b>	J	30	–	–	–
	40	<b>3NA3817</b>	J	40	–	–	–
	50	<b>3NA3820</b>	J	50	–	–	–
	63	<b>3NA3822</b>	J	60	–	–	–
	80	<b>3NA3824</b>	J	70	–	–	–
	100	<b>3NA3830</b>	J	90	–	–	–
	100	<b>3NA3830</b>	J	110	–	–	–
	120	<b>3NA3832</b>	J	125	–	–	–
160	<b>3NA3836</b>	J	150	–	–	–	

2

# SINAMICS G220 built-in and wall-mounted units

Clicking to SiePortal

6SL3255-0AA00-5AA0



Clean Power/IP20/UL Open Type · 380 ... 500 V 3 AC · 7.5 kW to 55 kW (10 hp to 75 hp)

## Selection and ordering data

SINAMICS G220 built-in and wall-mounted units → Configuration with power components (see right page)

Rated power		Rated output current				Rated input current		Frame size	SINAMICS G220 Clean Power with integrated line filter	
Low overload (LO)		High overload (HO)		Low overload (LO)		High overload (HO)		Low overload (LO)	Article No.	
Acc. to IEC	Acc. to NEC	Acc. to IEC	Acc. to NEC	Acc. to IEC	Acc. to NEC	Acc. to IEC	Acc. to NEC	Acc. to IEC		Acc. to NEC
400 V	480 V	400 V	480 V	400 V	480 V	400 V	480 V	400 V		480 V
kW	hp	kW	hp	A	A	A	A	A	A	

380 ... 500 V 3 AC · Rated pulse frequency 4 kHz · Input frequency 50/60 Hz (47 ... 63 Hz)

7.5	10	5.5	7.5	19	14	14.5	11	15.2	12.3	FSD1	6SL4113-2 ■ A 16 - 2 ■ F 0
11	15	7.5	10	27	21	19	14	20.6	17.5	FSD1	6SL4113-2 ■ A 17 - 2 ■ F 0
15	20	11	15	34	27	27	21	28.0	23.2	FSD1	6SL4113-2 ■ A 18 - 2 ■ F 0
18.5	25	15	20	40	34	34	27	33.5	28.5	FSD1	6SL4113-2 ■ A 20 - 2 ■ F 0
22	30	18.5	25	46	40	40	34	39.9	34.2	FSD1	6SL4113-2 ■ A 21 - 2 ■ F 0
30	40	22	30	63	52	46	40	52.9	44.4	FSD2	6SL4113-2 ■ A 23 - 2 ■ F 0
37	50	30	40	75	65	63	52	65.3	55.7	FSD2	6SL4113-2 ■ A 24 - 2 ■ F 0
45	60	37	50	90	77	75	65	77.5	65.5	FSE	6SL4113-2 ■ A 26 - 2 ■ F 0
55	75	45	60	112	96	90	77	95.1	81.9	FSE	6SL4113-2 ■ A 27 - 2 ■ F 0

### Article No. supplements

Degree of protection	Cooling	Coating acc. to IEC 60721-3-3: 2002	Housing	Order codes	
IP20/UL Open Type	Internal	Class 3C2 Class 3C3	Standard	C D	
<b>Hardware configuration</b>				A	
Standard					
<b>Line filter</b>				2	
With integrated line filter Category C2					
<b>Additional hardware option</b>				A B E F	
Without hardware option or with more than one hardware option (see Special versions)					
OM-DQ Option Module DRIVE-CLiQ					
OM-IIoT Option Module IIoT					
OM-SMT Option Module Safe Motor Temperature					
<b>Communication</b>				F	
PROFINET, Modbus TCP and EtherNet/IP					
<b>Special versions</b>					
Only for selection of more than one hardware option (Additional hardware option = "A")				6SL4113-2 ■ ... - . A . 0	-Z...+...+...
OM-DQ Option Module DRIVE-CLiQ					T01
OM-IIoT Option Module IIoT					T04
OM-SMT Option Module Safe Motor Temperature					T05

### More information

Further technical specifications and documentation are available on the internet at:  
[www.siemens.com/sinamics-g220/documentation](http://www.siemens.com/sinamics-g220/documentation)

and concerning ordering and configuration via the Siemens Product Configurator in SiePortal:  
[www.siemens.com/sinamics-g220/configuration](http://www.siemens.com/sinamics-g220/configuration)

2

Clicking to SiePortal

6SL3255-0AA00-5AA0



## SINAMICS G220 built-in and wall-mounted units

Clean Power/IP20/UL Open Type · 380 ... 500 V 3 AC · 7.5 kW to 55 kW (10 hp to 75 hp)

Line-side components					DC link components	Load-side power components		
Line reactors	Recommended line-side overcurrent protection devices				Braking resistors <sup>1)</sup>	Output reactors	dv/dt filters plus VPL	
	More information at: <a href="http://www.siemens.com/sinamics-g220/ocpd">www.siemens.com/sinamics-g220/ocpd</a>							
	Fuses IEC-compliant		Fuses UL/cUL-compliant Rated voltage 600 V AC					
	Current		Fuse type	Current				
Article No.	A	Article No.	Class/Article No.	A	Article No.	Article No.	Article No.	
A DC line reactor is integrated – therefore no line reactor is required.	32	<b>3NA3812</b>	J	30	–	–	–	
	40	<b>3NA3817</b>	J	40	–	–	–	
	50	<b>3NA3820</b>	J	50	–	–	–	
	63	<b>3NA3822</b>	J	60	–	–	–	
	80	<b>3NA3824</b>	J	70	–	–	–	
	100	<b>3NA3830</b>	J	90	–	–	–	
	100	<b>3NA3830</b>	J	110	–	–	–	
	125	<b>3NA3832</b>	J	125	–	–	–	
	160	<b>3NA3836</b>	J	150	–	–	–	

<sup>1)</sup> Available soon.



# SINAMICS G220 built-in and wall-mounted units

Clean Power/IP55/UL Type 12 · 380 ... 500 V 3 AC · 7.5 kW to 55 kW (10 hp to 75 hp)

## Selection and ordering data

SINAMICS G220 built-in and wall-mounted units → Configuration with power components (see right page)

Rated power, Rated output current, Rated input current, Frame size, **SINAMICS G220 Clean Power with integrated line filter** NEW

Low overload (LO)		High overload (HO)		Low overload (LO)		High overload (HO)		Low overload (LO)		Article No.
Acc. to IEC	Acc. to NEC	Acc. to IEC	Acc. to NEC	Acc. to IEC	Acc. to NEC	Acc. to IEC	Acc. to NEC	Acc. to IEC	Acc. to NEC	
400 V	480 V	400 V	480 V	400 V	480 V	400 V	480 V	400 V	480 V	

**380 ... 500 V 3 AC · Rated pulse frequency 4 kHz · Input frequency 50/60 Hz (47 ... 63 Hz)**

7.5	10	5.5	7.5	19	14	14.5	11	15.2	12.3	FSD1	6SL4113-2 ■ ■ ■ 16 - 2 ■ F 0
11	15	7.5	10	27	21	19	14	20.6	17.5	FSD1	6SL4113-2 ■ ■ ■ 17 - 2 ■ F 0
15	20	11	15	34	27	27	21	28.0	23.2	FSD1	6SL4113-2 ■ ■ ■ 18 - 2 ■ F 0
18.5	25	15	20	40	34	34	27	33.5	28.5	FSD1	6SL4113-2 ■ ■ ■ 20 - 2 ■ F 0
22	30	18.5	25	46	40	40	34	39.9	34.2	FSD1	6SL4113-2 ■ ■ ■ 21 - 2 ■ F 0
30	40	22	30	63	52	46	40	52.9	44.4	FSD2	6SL4113-2 ■ ■ ■ 23 - 2 ■ F 0
37	50	30	40	75	65	63	52	65.3	55.7	FSD2	6SL4113-2 ■ ■ ■ 24 - 2 ■ F 0
45	60	37	50	90	77	75	65	77.5	65.5	FSE	6SL4113-2 ■ ■ ■ 26 - 2 ■ F 0
55	75	45	60	112	96	90	77	95.1	81.9	FSE	6SL4113-2 ■ ■ ■ 27 - 2 ■ F 0

### Article No. supplements

Degree of protection	Cooling	Coating	Housing						
IP55/UL Type 12	Internal	acc. to IEC 60721-3-3: 2002 Class 3C2	Standard Maintenance switch <sup>1)</sup>	J					
		Class 3C3	Standard Maintenance switch <sup>1)</sup>	L					
				K					
				M					
<b>Hardware configurations</b>									
Standard				A					
Gland plate for connecting in IP55 degree of protection according to IEC				P					
Gland plate for connecting in UL Type 12 degree of protection				Q					
<b>Line filter</b>									
With integrated line filter Category C2								2	
<b>Additional hardware option</b>									
Without hardware option or with more than one hardware option (see Special versions)									A
OM-DQ Option Module DRIVE-CLiQ									B
OM-IloT Option Module IloT									E
OM-SMT Option Module Safe Motor Temperature									F
<b>Communication</b>									
PROFINET, Modbus TCP and EtherNet/IP									F
<b>Special versions</b>									
Only for selection of more than one hardware option (Additional hardware option = "A")									
OM-DQ Option Module DRIVE-CLiQ									T01
OM-IloT Option Module IloT									T04
OM-SMT Option Module Safe Motor Temperature									T05

### More information

Further technical specifications and documentation are available on the internet at:  
[www.siemens.com/sinamics-g220/documentation](http://www.siemens.com/sinamics-g220/documentation)  
 and concerning ordering and configuration via the Siemens Product Configurator in SiePortal:  
[www.siemens.com/sinamics-g220/configuration](http://www.siemens.com/sinamics-g220/configuration)

<sup>1)</sup> Available soon.



Clicking to SiePortal

6SL3255-0AA00-5AA0



## SINAMICS G220 built-in and wall-mounted units

Clean Power/IP55/UL Type 12 · 380 ... 500 V 3 AC · 7.5 kW to 55 kW (10 hp to 75 hp)

Line-side components					DC link components	Load-side power components	
Line reactors	Recommended line-side overcurrent protection devices				Braking resistors	Output reactors	dv/dt filters plus VPL
	More information at: <a href="http://www.siemens.com/sinamics-g220/ocpd">www.siemens.com/sinamics-g220/ocpd</a>				Degree of protection IP54		
	Fuses IEC-compliant		Fuses UL/cUL-compliant Rated voltage 600 V AC				
	Current		Fuse type	Current			
Article No.	A	Article No.	Class/Article No.	A	Article No.	Article No.	Article No.
A DC line reactor is integrated – therefore no line reactor is required.	25	<b>3NA3810</b>	J	30	–	–	–
	40	<b>3NA3817</b>	J	40	–	–	–
	50	<b>3NA3820</b>	J	50	–	–	–
	63	<b>3NA3822</b>	J	60	–	–	–
	80	<b>3NA3824</b>	J	70	–	–	–
	80	<b>3NA3824</b>	J	90	–	–	–
	100	<b>3NA3830</b>	J	110	–	–	–
	125	<b>3NA3832</b>	J	125	–	–	–
	160	<b>3NA3836</b>	J	150	–	–	–

2

## SINAMICS G220 built-in and wall-mounted units

### Supplementary system components

#### Selection and ordering data

##### Supplementary system components for SINAMICS G220 built-in and wall-mounted units

Description	Article No.
<b>Option Modules <sup>1)</sup></b> for SINAMICS G220	
• OM-DQ Option Module DRIVE-CLiQ	<b>6SL4950-0AL00-0BA0</b>
• OM-IloT Option Module IloT	<b>6SL4950-0AL00-0EA0</b>
• OM-SMT Option Module Safe Motor Temperature	<b>6SL4950-0AL00-0FA0</b>
<b>Additional components</b> for SINAMICS G220	
• SINAMICS Smart Adapter Wi-Fi solution for the next generation of SINAMICS converters	<b>6SL4950-0AJ00-0AA0</b>
• SMC10 Sensor Module Cabinet-Mounted Without DRIVE-CLiQ cable	<b>6SL3055-0AA00-5AA3</b>
• SMC20 Sensor Module Cabinet-Mounted Without DRIVE-CLiQ cable	<b>6SL3055-0AA00-5BA3</b>
• SMC30 Sensor Module Cabinet-Mounted Without DRIVE-CLiQ cable	<b>6SL3055-0AA00-5CA2</b>
<b>Accessories for re-ordering of SMC10, SMC20 and SMC30</b>	
• Dust protection blanking plugs (50 units) For DRIVE-CLiQ port	<b>6SL3066-4CA00-0AA0</b>
<b>Smart Drive Interfaces</b> for SINAMICS G220	
• SINAMICS SDI Standard	Included in the scope of delivery of the converters
• SINAMICS SDI Pro 5.5" <sup>3)</sup>	<b>6SL4950-0AH35-2AA0</b>
• SINAMICS SDI Pro 5.5" handheld kit for use with the SINAMICS SDI Pro 5.5"	<b>6SL4950-0AH65-0AA0</b>
• SINAMICS SDI Pro 5.5" door mounting kit for mounting a SINAMICS SDI Pro 5.5" in control cabinet doors	<b>6SL4950-0AH55-0AA0</b>
• SINAMICS IP55 panel mounting frame	<b>6SL4950-0AH75-0AA0</b>

##### SINAMICS Drive Software Options for SINAMICS G220 built-in and wall-mounted units

Description	Article No.
Delivery with SINAMICS SD memory card, 8 GB The parameter assignment, firmware and licenses for a converter can be stored on the memory card.	
• Memory card without firmware (empty)	<b>6SL5970-0AA00-0AA0</b>
• With SINAMICS Motor Control Extended (license)	<b>6SL5970-0AA00-0AA0-Z H01</b>
• With SINAMICS Safety Integrated Extended (license)	<b>6SL5970-0AA00-0AA0-Z F01</b>
• With SINAMICS OPC UA Single Extended (license)	<b>6SL5970-0AA00-0AA0-Z H80</b>
• With SINAMICS Positioning Extended (license)	<b>6SL5970-0AA00-0AA0-Z E01</b>
• With SINAMICS Drive Control Chart Extended (license)	<b>6SL5970-0AA00-0AA0-Z J03</b>
• With SINAMICS Drive Control Chart Advanced (license)	<b>6SL5970-0AA00-0AA0-Z J04</b>
• Memory card with firmware V6.4	<b>6SL4170-1GE00-0AA0</b>
• With Firmware V6.4 and SINAMICS Motor Control Extended (license)	<b>6SL4170-1GE00-0AA0-Z H01</b>
• With Firmware V6.4 and SINAMICS Safety Integrated Extended (license)	<b>6SL4170-1GE00-0AA0-Z F01</b>
• With Firmware V6.4 and SINAMICS OPC UA Single Extended (license)	<b>6SL4170-1GE00-0AA0-Z H80</b>
• With Firmware V6.4 and SINAMICS Positioning Extended (license)	<b>6SL4170-1GE00-0AA0-Z E01</b>
• With Firmware V6.4 and SINAMICS Drive Control Chart Extended (license)	<b>6SL4170-1GE00-0AA0-Z J03</b>
• With Firmware V6.4 und SINAMICS Drive Control Chart Advanced (license)	<b>6SL4170-1GE00-0AA0-Z J04</b>

Description	Article No.
<b>Delivery in electronic form, eCoL (without memory card) <sup>2)</sup></b>	
• SINAMICS Motor Control Extended (license)	<b>6SL5977-0AA00-1DA0</b>
• SINAMICS Safety Integrated Extended (license)	<b>6SL5977-0AA00-2HA0</b>
• SINAMICS OPC UA Single Extended (license)	<b>6SL5977-0AA00-1GA0</b>
• SINAMICS Positioning Extended (license)	<b>6SL5977-0AA00-2EA0</b>
• SINAMICS Drive Control Chart Extended (license)	<b>6SL5977-0AA00-2FA0</b>
• SINAMICS Drive Control Chart Advanced (license)	<b>6SL5977-0AA00-3FA0</b>

For an overview and more information on all available firmware versions, see <https://support.industry.siemens.com/cs/document/109807094>

#### Environmental Product Declaration (EPD)

Environmental Product Declarations (EPD) are available as PDFs for this product.

The EPD PDF provides brief and concise information about the ecological properties of a product.

You can find more information on the internet at: <https://support.industry.siemens.com/cs/ww/en/ps/28308/cert?ci=5690>

#### More information

Further technical specifications and documentation, such as the operating instructions, are available on the internet at: [www.siemens.com/sinamics-g220/documentation](http://www.siemens.com/sinamics-g220/documentation)

Detailed information on the SINAMICS G220 built-in and wall-mounted units, including the latest technical documentation (brochures, tutorials, dimensional drawings, certificates, manuals and operating instructions), is available on the internet at: [www.siemens.com/sinamics-g220](http://www.siemens.com/sinamics-g220)

and also via the Siemens Product Configurator in SiePortal: [www.siemens.com/sinamics-g220/configuration](http://www.siemens.com/sinamics-g220/configuration)

<sup>1)</sup> Option Modules can also be ordered directly as a part of the converter as an additional hardware option or a special version.  
<sup>2)</sup> The memory card is not included in the scope of delivery. The licenses can also be ordered together with a memory card (see above). With the Certificate of License (CoL) in electronic form, the license is supplied as a PDF file. Notification of this with a download link is received by email.  
<sup>3)</sup> Available soon.

## Technical specifications

### General technical specifications

Article number	6SL411-0....-0.F0, 6SL4113-0.A..-2.F0
mounting position	Vertical
design of the protective insulation	SELV according to IEC 61800-5-1, protective separation from the line supply using double/reinforced insulation
operating resource protection class according to EN 61800-5-1	Class I (with protective conductor system) and Class III (SELV)
Relative humidity during operation maximum	95 %
certificate of suitability	CE, UL, KC, cUL according to UL 61800-5-1, EAC, UKCA
<ul style="list-style-type: none"> <li>for fail-safety</li> </ul>	SIL 3 according to IEC 61508 and IEC 61800-5-2, PL e according to ISO 13849-1, Category 4 according to ISO 13849-1
<ul style="list-style-type: none"> <li>for CE marking</li> </ul>	EMC directive 2014/30/EU; Low Voltage Directive 2014/35/EU; RoHS Directive 2011/65/EU; energy efficiency and eco design 2009/125/EU
standard for EMC according to EN 61800-3	IEC 61800-3
installation environment regarding EMC	
<ul style="list-style-type: none"> <li>environment A</li> </ul>	✓
<ul style="list-style-type: none"> <li>environment B</li> </ul>	—
Pulse frequency	4 kHz
Line power factor at rated power	
<ul style="list-style-type: none"> <li>Total minimum</li> </ul>	0.9
<ul style="list-style-type: none"> <li>Fundamental power factor cos phi 1</li> </ul>	0.98
Installation altitude at height above sea level without power reduction, max.	1 000 m

Article number	6SL411-0....-0.F0, 6SL4113-0.A..-2.F0
brake version	DC braking, compound braking, resistance braking with integrated brake chopper
type of cooling	Air cooling using an integrated fan
Bus system Protocol	Ethernet (for service and engineering)
design of the interface for bus system integrated note	with CM-PN
for signal line	
<ul style="list-style-type: none"> <li>connectable conductor cross-section</li> </ul>	0.2 ... 2.5 mm <sup>2</sup>
<ul style="list-style-type: none"> <li>Connectable conductor cross-section (AWG)</li> </ul>	24 ... 12
design of the sensor to detect the ambient temperature connectable	1 input for motor temperature, connectable PTC, KTY 84, PT1000, and bimetal temperature switch
product function for U/f control	
<ul style="list-style-type: none"> <li>ECO mode linear or quadratic</li> </ul>	✓
<ul style="list-style-type: none"> <li>flux current control</li> </ul>	✓
<ul style="list-style-type: none"> <li>linear or quadratic parameterization</li> </ul>	✓
<ul style="list-style-type: none"> <li>multi-point</li> </ul>	✓
Product function Vector control	
<ul style="list-style-type: none"> <li>without encoder</li> </ul>	✓
<ul style="list-style-type: none"> <li>with encoder</li> </ul>	✓
Product function Torque control	
<ul style="list-style-type: none"> <li>without encoder</li> </ul>	✓
<ul style="list-style-type: none"> <li>with encoder</li> </ul>	✓

### Cable length

Article number	6SL4112-0.A..-0.F0 6SL4113-0.A..-0.F0	6SL4113-2.A..-2.F0
Cable length		
<ul style="list-style-type: none"> <li>for braking resistor / maximum</li> </ul>	10 m	10 m
<ul style="list-style-type: none"> <li>for motor / shielded</li> </ul>	200 m	200 m
<ul style="list-style-type: none"> <li>- maximum</li> </ul>	200 m	200 m
<ul style="list-style-type: none"> <li>- with EMC category C2 / maximum</li> </ul>		150 m
<ul style="list-style-type: none"> <li>for motor / unshielded / maximum</li> </ul>	300 m	300 m

## SINAMICS G220 built-in and wall-mounted units

### Technical specifications

#### Inputs and outputs

Article number	6SL411-0....-0.F0, 6SL4113-2.A..-2.F0
<b>Digital inputs</b>	
design of the electrical isolation of the digital input	Optocoupler
number of digital inputs	6, additionally 2 AI configurable as 2 DI
designation	DI0..DI5
type of digital input according to IEC 61131-2	Type 3
response time	
• for signal <0> to <1> maximum	0.05 ms
• for signal <1> to <0> maximum	0.05 ms
• of the digital input when used as digital input	0.25 ms
• parameterizable	Yes
- minimum	0.25 ms
input current at digital standard inputs maximum	4 mA
input voltage maximum permissible	30 V
input voltage when used as digital input	
• for signal <0> to <1>	11 V
• for signal <1> to <0>	5 V
<b>Fail-safe digital input</b>	
number of digital inputs with fail-safe	1, additionally 4 DI configurable as 2 FDI
designation	FDI0 (FDI1, FDI2)
type of digital input according to IEC 61131-2	type 3
response time parameterizable minimum	1 ms
certificate of suitability for fail-safety	SIL 3 according to IEC 61508 and IEC 61800-5-2, PL e according to ISO 13849-1, Category 4 according to ISO 13849-1
<b>Rapid input</b>	
number of digital inputs as rapid input	1
designation of the high-speed input	DI5
type of digital input according to IEC 61131-2	type 3
pulse frequency	32 kHz
response time of the high-speed input when used as probe input	
• for signal <0> to <1> maximum	0.01 ms
• for signal <1> to <0> maximum	0.01 ms

Article number	6SL411-0....-0.F0, 6SL4113-2.A..-2.F0
<b>Digital outputs</b>	
number of digital outputs	
• as transistor	1
• as pulse train output	0
designation	DO0
output current of digital outputs as transistor with resistive load at DC	0.5 A
• maximum	0.5 A
output voltage of digital outputs as transistor with resistive load at DC maximum	30 V
response time of the digital output	
• as transistor for signal <0> to <1> maximum	0.05 ms
• as transistor for signal <1> to <0> maximum	0.1 ms
• parameterizable minimum	0.25 ms
product function	
• overload protection at digital output as transistor	No
• short-circuit protection at digital output as transistor	No
• reverse voltage protection of digital outputs as transistor	Yes
diagnostics function at digital output as transistor open-circuit detection	No
product feature of the digital output as transistor	
• sourcing output	Yes
• sinking output	Yes
<b>Fail-safe digital output</b>	
number of digital outputs with fail-safe	1, with external 24 V supply
designation	FDO0
load resistance	48 ... 130 000 Ω
product function	
• overload protection at digital output with fail-safe	Yes
• response time with fail-safe parameterizable	Yes
• short-circuit protection at digital output with fail-safe	Yes
• reverse voltage protection of digital outputs with fail-safe	Yes
product feature of the digital output with fail-safe	
• sourcing output	Yes
• sinking output	Yes
diagnostics function at digital output with fail-safe open-circuit detection	No

## Technical specifications

Article number	6SL411-0....-0.F0, 6SL4113-2.A..-2.F0
<b>Relay output</b>	
number of digital outputs as relay change-over contact	2
designation of the digital output as relay change-over contact	DO1, DO2
response time of the digital output as relay output	3 ms
type of relay output	Changeover contact (CO)
operating cycles of digital outputs as relay output at DC maximum	300 000
output voltage of digital outputs as relay output	
• at DC maximum	30 V
• at DC minimum	0 V
• with resistive load at DC	30 V
output current of digital outputs as relay change-over contact with resistive load at DC	0.5 A
• maximum	0.5 A
<b>Analog inputs</b>	
number of analog inputs, number of analog inputs note	2, The analog inputs can be used as additional digital inputs.
designation	AI0, AI1
type of analog input	Differential input
• note	Can be toggled between current and voltage mode using a parameter
overvoltage protection	Yes
input voltage at the analog input	
• during operating mode selection: current input maximum permissible	8 V
• during operating mode selection: voltage input maximum permissible	35 V
• during operating mode selection: voltage input unipolar	0 ... 10 V
• during operating mode selection: voltage input bipolar	-10 ... +10 V
input voltage at analog inputs as voltage inputs	
• for signal <0> to <1>	11 V
• for signal <1> to <0>	5 V
input current at the analog input during operating mode selection: current input	
• maximum permissible	65 mA
• unipolar	0 ... 20 mA
• unipolar/ monitored	4 ... 20 mA
input current at digital standard inputs for signal <0> to <1> minimum	2.5 mA
consumed current during operating mode selection: voltage input typical	0.2 mA
input resistance at the analog input	
• during operating mode selection: voltage input	100 kΩ
• during operating mode selection: current input	120 Ω
A/D resolution at the analog input	16 bit

Article number	6SL411-0....-0.F0, 6SL4113-2.A..-2.F0
<b>Analog outputs</b>	
number of analog outputs	1
type of analog output	Non-isolated output
• note	Can be toggled between current and voltage mode using a parameter
designation	AO0
output current at analog output	0 ... 20 mA
during operating mode selection: current mode	20 mA
output voltage at analog output during operating mode selection: voltage mode	10 V
output load at analog output	
• during operating mode selection: voltage mode minimum	500 Ω
• during operating mode selection: current mode maximum	10 000 Ω
offset of the output voltage with output value 0 at analog output during operating mode selection: voltage mode maximum	50 mV
response time of the analog output parameterizable minimum	0.25 ms
protection function of analog outputs short-circuit protection	Yes
protection function of analog input overvoltage protection note	Analog inputs are protected against inputs in a voltage range of ±35 V and have a common mode voltage in the range of ±15 V
diagnostics function at analog output open-circuit detection	No
A/D resolution at analog output	16 bit
<b>Analog input for acquisition of the motor temperature</b>	
design of the sensor for detection of the motor temperature connectable	
• bimetallic temperature switch with NC contact	Yes
• KTY 84	Yes
• KTY 84 note	Short-circuit monitoring < 50 Ohm; wire breakage >2120 Ohm; measurement current 2 mA
• Pt100	No
• Pt1000	Yes
• Pt1000 note	Short-circuit monitoring < 603 Ohm; wire breakage >2120 Ohm; measurement current 2 mA
• PTC	Yes
• PTC note	Type A, according to IEC 60947-8, short-circuit monitoring < 20 Ohm, overtemperature >1650 Ohm, measuring current 2 mA

## SINAMICS G220 built-in and wall-mounted units

### Technical specifications

#### Environmental data

Article number		6SL4112-0CA..-0.F0, 6SL4113-2CA..-0.F0	6SL411..-0JA..-0.F0, 6SL411..-0LA..-0.F0, 6SL411..-0KA..-0.F0, 6SL411..-0MA..-0.F0
protection class IP		IP20	IP55
degree of protection NEMA rating		UL open type	UL type 12
<b>Ambient temperature</b>			
ambient temperature			
• during storage	°C (°F)	-25 ... +55 (-13 ... +131)	-25 ... +55 (-13 ... +131)
• during transport	°C (°F)	-40 ... +70 (-40 ... +158)	-40 ... +70 (-40 ... +158)
• during operation	°C (°F)	-20 ... +60 (-4 ... +140)	-20 ... +50 (-4 ... +122)
• with low overload without power reduction during operation maximum	°C (°F)	45 (113)	40 (104)
• with high overload without power reduction during operation maximum	°C (°F)	50 (122)	45 (113)
<b>Resistance to chemically active substances</b>			
during storage		Class 1C2 according to IEC 60721-3-1: 2002	Class 1C2 according to IEC 60721-3-1: 2002
• note		in the transport packaging	in the transport packaging
during transport		Class 2C2 according to IEC 60721-3-2:1997	Class 2C2 according to IEC 60721-3-2:1997
• note		in marine- and weather-resistant transport packaging	in marine- and weather-resistant transport packaging
during operation		Class 3C2, according to IEC 60721-3-3: 2002	Class 3C2, according to IEC 60721-3-3: 2002
<b>Resistance to biologically active substances</b>			
during storage		Class 1B1 according to IEC 60721-3-1:1997	Class 1B1 according to IEC 60721-3-1:1997
• note		in the transport packaging	in the transport packaging
during transport		Class 2B1 according to IEC 60721-3-2:1997	Class 2B1 according to IEC 60721-3-2:1997
• note		in the transport packaging	in the transport packaging
during operation		Class 3B1 according to IEC 60721-3-3: 2002	Class 3B1 according to IEC 60721-3-3: 2002
<b>Resistance to climatic environmental conditions</b>			
during transport		Class 2K4 according to IEC 60721-3-2:1997	Class 2K4 according to IEC 60721-3-2:1997
• note		in the transport packaging; temperature -40 ... +70 °C; relative atmospheric humidity 5..95% (without condensation)	in the transport packaging; temperature -40 ... +70 °C; relative atmospheric humidity 5..95% (without condensation)
during storage		Class 1K4 according to IEC 60721-3-1:1997	Class 1K4 according to IEC 60721-3-1:1997
• note		in the transport packaging; temperature -25 ... +55 °C; relative atmospheric humidity 5..95% (without condensation), storage altitude <=4000m; condensation, spray water, ice formation, salt mist not permissible	in the transport packaging; temperature -25 ... +55 °C; relative atmospheric humidity 5..95% (without condensation), storage altitude <=4000m; condensation, spray water, ice formation, salt mist not permissible
during operation		Class 3K3 according to IEC 60721-3-3 Ed. 2.2: 2002	Class 3K3 according to IEC 60721-3-3 Ed. 2.2: 2002
• note		with increased ruggedness with respect to relative humidity, with HO: without derating (temperature -20 ... +50°C); with reduction of the permissible output current by 2.5 % per K (>50 ... 60 °C) with LO: without derating (temperature -20 ... +45°C); with reduction of the permissible output current by 1.5 % per K (>45 ... 50 °C), by 2.5 % pro K (>50 ... 60°C), relative humidity 5 ... 95 % (without condensation; better than Class 3K3); ice formation, condensation, dripping water, spray water, splash water, jet water are not permissible	with increased ruggedness with respect to relative humidity, with HO: without temperature derating (temperature -20..45 °C), with reduction of the permissible output current, by 1.5 % per K (>45 ... 50 °C) with LO: without temperature derating (temperature -20..40 °C), by 1.5 % per K (>40 ... 50 °C), relative humidity 5 ... 95 % (without condensation, better than Class 3K3), ice formation, condensation, dripping water, spray water, splash water, jet water not permissible
<b>Resistance to mechanical environmental conditions</b>			
during storage		Class 1M2 according to IEC 60721-3-1:1997	Class 1M2 according to IEC 60721-3-1:1997
• note		in the transport packaging	in the transport packaging
during transport		Class 2M3 according to IEC 60721-3-2:1997	Class 2M3 according to IEC 60721-3-2:1997
• note		in the transport packaging	in the transport packaging
during operation		Class 3M1 according to IEC 60721-3-3 Ed. 2.2: 2002	Class 3M1 according to IEC 60721-3-3 Ed. 2.2: 2002
• note		Vibration test (test Fc according to IEC 60068-2-6; sinusoidal; 9 ... 29 Hz (amplitude 0.3 mm); 29 ... 200 Hz (acceleration 1g); 10 frequency cycles (per axis)); shock test (test Ea according to IEC 60068-2-27; semi-sinusoidal; peak acceleration 5g; duration 30 ms (3 shocks per direction))	Vibration test (test Fc according to IEC 60068-2-6; sinusoidal; 9 ... 29 Hz (amplitude 0.3 mm); 29 ... 200 Hz (acceleration 1g); 10 frequency cycles (per axis)); shock test (test Ea according to IEC 60068-2-27; semi-sinusoidal; peak acceleration 5g; duration 30 ms (3 shocks per direction))



## Technical specifications

### Electrical specifications

Article number		6SL4112-0.A05-0.F0	6SL4112-0.A06-0.F0	6SL4112-0.A08-0.F0	6SL4112-0.A10-0.F0
Input voltage		3 AC	3 AC	3 AC	3 AC
Input frequency	Hz	47 ... 63	47 ... 63	47 ... 63	47 ... 63
manufacturer data rating plate electrical input frequency		50/60 Hz	50/60 Hz	50/60 Hz	50/60 Hz
Line voltage	V	200 ... 240	200 ... 240	200 ... 240	200 ... 240
output current rated value					
• without overload	A	4.1	4.9	6.7	8.8
• with low overload	A	3.9	4.7	6.5	8.5
• with high overload	A	2.9	3.9	4.7	6.5
supply voltage according to NEC	V	200 ... 240	200 ... 240	200 ... 240	200 ... 240
output current rated value according to NEC					
• without overload	A	3.3	4.4	6.2	7
• with low overload	A	3.2	4.2	6	6.8
• with high overload	A	2.2	3.2	4.2	6
rated power					
• at 230 V					
- with high overload	kW	0.37	0.55	0.75	1.1
- with low overload	kW	0.55	0.75	1.1	1.5
rated power [hp]					
• at 240 V					
- with high overload according to NEC	hp	0.5	0.75	1	1.5
- with low overload according to NEC	hp	0.75	1	1.5	2
Article number		6SL4112-0.A11-0.F0	6SL4112-0.A12-0.F0	6SL4112-0.A13-0.F0	6SL4112-0.A15-0.F0
Input voltage		3 AC	3 AC	3 AC	3 AC
Input frequency	Hz	47 ... 63	47 ... 63	47 ... 63	47 ... 63
manufacturer data rating plate electrical input frequency		50/60 Hz	50/60 Hz	50/60 Hz	50/60 Hz
Line voltage	V	200 ... 240	200 ... 240	200 ... 240	200 ... 240
output current rated value					
• without overload	A	11.3	14.9	19.5	27.7
• with low overload	A	11	14.5	19	27
• with high overload	A	8.5	11	14.5	19
supply voltage according to NEC	V	200 ... 240	200 ... 240	200 ... 240	200 ... 240
output current rated value according to NEC					
• without overload	A	9.9	12.8	15.6	22.6
• with low overload	A	9.6	12.4	15.2	22
• with high overload	A	6.8	9.6	12.4	15.2
rated power					
• at 230 V					
- with high overload	kW	1.5	2.2	3	4
- with low overload	kW	2.2	3	4	5.5
rated power [hp]					
• at 240 V					
- with high overload according to NEC	hp	2	3	4	5
- with low overload according to NEC	hp	3	4	5	7.5

## SINAMICS G220 built-in and wall-mounted units

### Technical specifications

Article number		6SL4112-0.A16-0.F0	6SL4112-0.A17-0.F0	6SL4112-0.A18-0.F0	6SL4112-0.A20-0.F0
Input voltage		3 AC	3 AC	3 AC	3 AC
Input frequency	Hz	47 ... 63	47 ... 63	47 ... 63	47 ... 63
manufacturer data rating plate electrical input frequency		50/60 Hz	50/60 Hz	50/60 Hz	50/60 Hz
Line voltage	V	200 ... 240	200 ... 240	200 ... 240	200 ... 240
output current rated value					
• without overload	A	34.9	47.2	64.7	77
• with low overload	A	34	46	63	75
• with high overload	A	27	40	46	63
supply voltage according to NEC	V	200 ... 240	200 ... 240	200 ... 240	200 ... 240
output current rated value according to NEC					
• without overload	A	28.8	43.1	55.4	69.8
• with low overload	A	28	42	54	68
• with high overload	A	22	28	42	54
rated power at 230 V					
• with high overload	kW	5.5	7.5	11	15
• with low overload	kW	7.5	11	15	18.5
rated power [hp] at 240 V					
• with high overload according to NEC	hp	7.5	10	15	20
• with low overload according to NEC	hp	10	15	20	25
Article number		6SL4112-0.A21-0.F0		6SL4112-0.A23-0.F0	
Input voltage		3 AC		3 AC	
Input frequency	Hz	47 ... 63		47 ... 63	
manufacturer data rating plate electrical input frequency		50/60 Hz		50/60 Hz	
Line voltage	V	200 ... 240		200 ... 240	
output current rated value					
• without overload	A	92.4		114.9	
• with low overload	A	90		112	
• with high overload	A	75		90	
supply voltage according to NEC	V	200 ... 240		200 ... 240	
output current rated value according to NEC					
• without overload	A	82.1		106.7	
• with low overload	A	80		104	
• with high overload	A	68		80	
rated power at 230 V					
• with high overload	kW	18.5		22	
• with low overload	kW	22		30	
rated power [hp] at 240 V					
• with high overload according to NEC	hp	25		30	
• with low overload according to NEC	hp	30		40	

## SINAMICS G220 built-in and wall-mounted units

## Technical specifications

Article number		6SL4113-0.A08-..F0	6SL4113-0.A10-..F0	6SL4113-0.A11-..F0	6SL4113-0.A12-..F0
Input voltage		3 AC	3 AC	3 AC	3 AC
Input frequency	Hz	47 ... 63	47 ... 63	47 ... 63	47 ... 63
manufacturer data rating plate electrical input frequency		50/60 Hz	50/60 Hz	50/60 Hz	50/60 Hz
Line voltage	V	380 ... 415	380 ... 415	380 ... 415	380 ... 415
output current rated value					
• without overload	A	4.1	4.9	6.7	8.8
• with low overload	A	3.9	4.7	6.5	8.5
• with high overload	A	2.9	3.9	4.7	6.5
• for SRM	A	3.9	4.7	6.5	8.5
supply voltage according to NEC	V	440 ... 500	440 ... 500	440 ... 500	440 ... 500
output current rated value according to NEC					
• without overload	A	3.1	3.5	5	6.4
• with low overload	A	3	3.4	4.8	6.2
• with high overload	A	2.1	3	3.4	4.8
rated power					
• at 400 V for SRM					
- with high overload	kW	0.75	1.1	1.5	2.2
- with low overload	kW	1.1	1.5	2.2	3
• at 400 V					
- with high overload	kW	0.75	1.1	1.5	2.2
- with low overload	kW	1.1	1.5	2.2	3
• at 500 V					
- with high overload	kW	0.8	1.1	1.5	2.2
- with low overload	kW	1.1	1.5	2.2	3
rated power [hp] at 480 V					
• with high overload according to NEC	hp	1	1.5	2	3
• with low overload according to NEC	hp	1.5	2	3	4

## SINAMICS G220 built-in and wall-mounted units

### Technical specifications

Article number		6SL4113-0.A13-..F0	6SL4113-0.A15-..F0	6SL4113-..A16-..F0	6SL4113-..A17-..F0
Input voltage		3 AC	3 AC	3 AC	3 AC
Input frequency	Hz	47 ... 63	47 ... 63	47 ... 63	47 ... 63
manufacturer data rating plate electrical input frequency		50/60 Hz	50/60 Hz	50/60 Hz	50/60 Hz
Line voltage	V	380 ... 415	380 ... 415	380 ... 415	380 ... 415
output current rated value					
• without overload	A	11.3	14.9	19.5	27.7
• with low overload	A	11	14.5	19	27
• with high overload	A	8.5	11	14.5	19
• for SRM	A	11	14.5	19	27
supply voltage according to NEC	V	440 ... 500	440 ... 500	440 ... 500	440 ... 500
output current rated value according to NEC					
• without overload	A	7.8	11.3	14.4	21.6
• with low overload	A	7.6	11	14	21
• with high overload	A	6.2	7.6	11	14
rated power					
• at 400 V for SRM					
- with high overload	kW	3	4	5.5	7.5
- with low overload	kW	4	5.5	7.5	11
• at 400 V					
- with high overload	kW	3	4	5.5	7.5
- with low overload	kW	4	5.5	7.5	11
• at 500 V					
- with high overload	kW	3	4	5.5	7.5
- with low overload	kW	4	5.5	7.5	11
rated power [hp] at 480 V					
• with high overload according to NEC	hp	4	5	7.5	10
• with low overload according to NEC	hp	5	7.5	10	15

## SINAMICS G220 built-in and wall-mounted units

## Technical specifications

Article number		6SL4113-..A18-..F0	6SL4113-..A20-..F0	6SL4113-..A21-..F0	6SL4113-..A23-..F0
Input voltage		3 AC	3 AC	3 AC	3 AC
Input frequency	Hz	47 ... 63	47 ... 63	47 ... 63	47 ... 63
manufacturer data rating plate electrical input frequency		50/60 Hz	50/60 Hz	50/60 Hz	50/60 Hz
Line voltage	V	380 ... 415	380 ... 415	380 ... 415	380 ... 415
output current rated value					
• without overload	A	34.9	41.1	47.2	64.7
• with low overload	A	34	40	46	63
• with high overload	A	27	34	40	46
• for SRM	A	35	43	50	69
supply voltage according to NEC	V	440 ... 500	440 ... 500	440 ... 500	440 ... 500
output current rated value according to NEC					
• without overload	A	27.7	34.9	41.1	53.4
• with low overload	A	27	34	40	52
• with high overload	A	21	27	34	40
rated power					
• at 400 V for SRM					
- with high overload	kW	11	15	18.5	22
- with low overload	kW	15	18.5	22	30
• at 400 V					
- with high overload	kW	11	15	18.5	22
- with low overload	kW	15	18.5	22	30
• at 500 V					
- with high overload	kW	11	15	18.5	22
- with low overload	kW	15	18.5	22	30
rated power [hp] at 480 V					
• with high overload according to NEC	hp	15	20	25	30
• with low overload according to NEC	hp	20	25	30	40

## SINAMICS G220 built-in and wall-mounted units

### Technical specifications

Article number		6SL4113-..A24-..F0	6SL4113-..A26-..F0	6SL4113-..A27-..F0
Input voltage		3 AC	3 AC	3 AC
Input frequency	Hz	47 ... 63	47 ... 63	47 ... 63
manufacturer data rating plate electrical input frequency		50/60 Hz	50/60 Hz	50/60 Hz
Line voltage	V	380 ... 415	380 ... 415	380 ... 415
output current rated value				
• without overload	A	77	92.4	114.9
• with low overload	A	75	90	112
• with high overload	A	63	75	90
• for SRM	A	85	103	123
supply voltage according to NEC	V	440 ... 500	440 ... 500	440 ... 500
output current rated value according to NEC				
• without overload	A	66.7	79	98.5
• with low overload	A	65	77	96
• with high overload	A	52	65	77
rated power				
• at 400 V for SRM				
- with high overload	kW	30	37	45
- with low overload	kW	37	45	55
• at 400 V				
- with high overload	kW	30	37	45
- with low overload	kW	37	45	55
• at 500 V				
- with high overload	kW	30	37	45
- with low overload	kW	37	45	55
rated power [hp] at 480 V				
• with high overload according to NEC	hp	40	50	60
• with low overload according to NEC	hp	50	60	75



## SINAMICS G220 built-in and wall-mounted units

## Technical specifications

## Power loss

Article number		6SL4112-0CA05-0AF0	6SL4112-0CA06-0AF0	6SL4112-0CA08-0AF0	6SL4112-0CA10-0AF0
rated power at 230 V with low overload	kW	0.55	0.75	1.1	1.5
power loss [W] of the CDM or SDOM					
• at the operating point (90/100)	W	66.9	78.6	107	144
• in standby mode of operation	W	15.6	15.6	15.6	15.6
• at the operating point (90/100) according to NEC	W	58.1	71.5	98.6	112
• in standby mode of operation according to NEC	W	15.6	15.6	15.6	15.6
Article number		6SL4112-0CA11-0AF0	6SL4112-0CA12-0AF0	6SL4112-0CA13-0AF0	6SL4112-0CA15-0AF0
rated power at 230 V with low overload	kW	2.2	3	4	5.5
power loss [W] of the CDM or SDOM					
• at the operating point (90/100)	W	191	202	277	373
• in standby mode of operation	W	15.6	19.2	19.2	21.6
• at the operating point (90/100) according to NEC	W	166	174	213	296
• in standby mode of operation according to NEC	W	15.6	19.2	19.2	21.6
Article number		6SL4112-0CA16-0AF0	6SL4112-0CA17-0AF0	6SL4112-0CA18-0AF0	
rated power at 230 V with low overload	kW	7.5	11	15	
power loss [W] of the CDM or SDOM					
• at the operating point (90/100)	W	498	566	842	
• in standby mode of operation	W	21.6	28.8	30	
• at the operating point (90/100) according to NEC	W	392	511	694	
• in standby mode of operation according to NEC	W	21.6	28.8	30	
Article number		6SL4112-0CA20-0AF0	6SL4112-0CA21-0AF0	6SL4112-0CA23-0AF0	
rated power at 230 V with low overload	kW	18.5	22	30	
power loss [W] of the CDM or SDOM					
• at the operating point (90/100)	W	1 060	1 150	1 530	
• in standby mode of operation	W	30	34.8	34.8	
• at the operating point (90/100) according to NEC	W	935	1 000	1 390	
• in standby mode of operation according to NEC	W	30	34.8	34.8	
Article number		6SL4113-0CA08-0AF0	6SL4113-0CA10-0AF0	6SL4113-0CA11-0AF0	6SL4113-0CA12-0AF0
rated power at 400 V with low overload	kW	1.1	1.5	2.2	3
power loss [W] of the CDM or SDOM					
• at the operating point (90/100)	W	77.2	90.6	123	165
• in standby mode of operation	W	14.3	14.3	14.3	14.3
• at the operating point (90/100) according to NEC	W	72.2	77.3	103	131
• in standby mode of operation according to NEC	W	14.3	14.3	14.3	14.3

## SINAMICS G220 built-in and wall-mounted units

### Technical specifications

Article number		6SL4113-0CA13-0AF0	6SL4113-0CA15-0AF0	6SL4113-0CA16-0AF0	6SL4113-0CA17-0AF0
rated power at 400 V with low overload	kW	4	5.5	7.5	11
power loss [W] of the CDM or SDOM					
• at the operating point (90/100)	W	216	238	314	406
• in standby mode of operation	W	14.3	17.6	17.6	19.8
• at the operating point (90/100) according to NEC	W	161	206	255	340
• in standby mode of operation according to NEC	W	14.3	17.6	17.6	19.8
Article number		6SL4113-0CA18-0AF0	6SL4113-0CA20-0AF0	6SL4113-0CA21-0AF0	6SL4113-0CA23-0AF0
rated power at 400 V with low overload	kW	15	18.5	22	30
power loss [W] of the CDM or SDOM					
• at the operating point (90/100)	W	534	562	662	888
• in standby mode of operation	W	19.8	25.3	25.3	27.5
• at the operating point (90/100) according to NEC	W	441	508	608	765
• in standby mode of operation according to NEC	W	19.8	25.3	25.3	27.5
Article number		6SL4113-0CA24-0AF0	6SL4113-0CA26-0AF0	6SL4113-0CA27-0AF0	
rated power at 400 V with low overload	kW	37	45	55	
power loss [W] of the CDM or SDOM					
• at the operating point (90/100)	W	1 110	1 230	1 600	
• in standby mode of operation	W	27.5	31.9	31.9	
• at the operating point (90/100) according to NEC	W	992	1 100	1 430	
• in standby mode of operation according to NEC	W	27.5	31.9	31.9	
Article number		6SL4113-0CA08-2AF0	6SL4113-0CA10-2AF0	6SL4113-0CA11-2AF0	6SL4113-0CA12-2AF0
rated power at 400 V with low overload	kW	1.1	1.5	2.2	3
power loss [W] of the CDM or SDOM					
• at the operating point (90/100)	W	78.3	92.2	126	170
• in standby mode of operation	W	14.3	14.3	14.3	14.3
• at the operating point (90/100) according to NEC	W	72.8	78.1	104	133
• in standby mode of operation according to NEC	W	14.3	14.3	14.3	14.3
Article number		6SL4113-0CA13-2AF0	6SL4113-0CA15-2AF0	6SL4113-0CA16-2AF0	6SL4113-0CA17-2AF0
rated power at 400 V with low overload	kW	4	5.5	7.5	11
power loss [W] of the CDM or SDOM					
• at the operating point (90/100)	W	224	244	324	420
• in standby mode of operation	W	14.3	17.6	17.6	19.8
• at the operating point (90/100) according to NEC	W	165	210	261	348
• in standby mode of operation according to NEC	W	14.3	17.6	17.6	19.8

## SINAMICS G220 built-in and wall-mounted units

## Technical specifications

Article number		6SL4113-0CA18-2AF0	6SL4113-0CA20-2AF0	6SL4113-0CA21-2AF0	6SL4113-0CA23-2AF0
rated power at 400 V with low overload	kW	15	18.5	22	30
power loss [W] of the CDM or SDOM					
• at the operating point (90/100)	W	555	564	665	899
• in standby mode of operation	W	19.8	25.3	25.3	27.5
• at the operating point (90/100) according to NEC	W	455	510	610	772
• in standby mode of operation according to NEC	W	19.8	25.3	25.3	27.5
Article number		6SL4113-0CA24-2AF0	6SL4113-0CA26-2AF0	6SL4113-0CA27-2AF0	
rated power at 400 V with low overload	kW	37	45	55	
power loss [W] of the CDM or SDOM					
• at the operating point (90/100)	W	1 119	1 246	1 634	
• in standby mode of operation	W	27.5	31.9	31.9	
• at the operating point (90/100) according to NEC	W	1 003	1 118	1 450	
• in standby mode of operation according to NEC	W	27.5	31.9	31.9	
Article number		6SL4112-0JA08-0AF0	6SL4112-0JA10-0AF0	6SL4112-0JA11-0AF0	6SL4112-0JA12-0AF0
rated power at 230 V with low overload	kW	1.1	1.5	2.2	3
power loss [W] of the CDM or SDOM					
• at the operating point (90/100)	W	108	135	166	214
• in standby mode of operation	W	25.2	25.2	25.2	25.2
• at the operating point (90/100) according to NEC	W	101	112	150	186
• in standby mode of operation according to NEC	W	25.2	25.2	25.2	25.2
Article number		6SL4112-0JA13-0AF0	6SL4112-0JA15-0AF0	6SL4112-0JA16-0AF0	6SL4112-0JA17-0AF0
rated power at 230 V with low overload	kW	4	5.5	7.5	11
power loss [W] of the CDM or SDOM					
• at the operating point (90/100)	W	290	409	540	566
• in standby mode of operation	W	25.2	31.2	31.2	38.4
• at the operating point (90/100) according to NEC	W	225	328	429	522
• in standby mode of operation according to NEC	W	25.2	31.2	31.2	38.4
Article number		6SL4112-0JA18-0AF0	6SL4112-0JA20-0AF0	6SL4112-0JA21-0AF0	6SL4112-0JA23-0AF0
rated power at 230 V with low overload	kW	15	18.5	22	30
power loss [W] of the CDM or SDOM					
• at the operating point (90/100)	W	840	1 060	1 160	1 540
• in standby mode of operation	W	38.4	38.4	44.4	44.4
• at the operating point (90/100) according to NEC	W	692	933	1 010	1 400
• in standby mode of operation according to NEC	W	38.4	38.4	44.4	44.4

## SINAMICS G220 built-in and wall-mounted units

### Technical specifications

Article number		<b>6SL4113-OJA08-0AF0</b>	<b>6SL4113-OJA10-0AF0</b>	<b>6SL4113-OJA11-0AF0</b>	<b>6SL4113-OJA12-0AF0</b>
rated power at 400 V with low overload	kW	1.1	1.5	2.2	3
power loss [W] of the CDM or SDOM					
• at the operating point (90/100)	W	85.5	96.8	123	156
• in standby mode of operation	W	23.1	23.1	23.1	23.1
• at the operating point (90/100) according to NEC	W	82.2	86.5	108	131
• in standby mode of operation according to NEC	W	23.1	23.1	23.1	23.1
Article number		<b>6SL4113-OJA13-0AF0</b>	<b>6SL4113-OJA15-0AF0</b>	<b>6SL4113-OJA16-0AF0</b>	<b>6SL4113-OJA17-0AF0</b>
rated power at 400 V with low overload	kW	4	5.5	7.5	11
power loss [W] of the CDM or SDOM					
• at the operating point (90/100)	W	193	249	325	440
• in standby mode of operation	W	23.1	23.1	23.1	28.6
• at the operating point (90/100) according to NEC	W	156	217	266	371
• in standby mode of operation according to NEC	W	23.1	23.1	23.1	28.6
Article number		<b>6SL4113-OJA18-0AF0</b>	<b>6SL4113-OJA20-0AF0</b>	<b>6SL4113-OJA21-0AF0</b>	<b>6SL4113-OJA23-0AF0</b>
rated power at 400 V with low overload	kW	15	18.5	22	30
power loss [W] of the CDM or SDOM					
• at the operating point (90/100)	W	573	557	655	887
• in standby mode of operation	W	28.6	29.7	29.7	35.2
• at the operating point (90/100) according to NEC	W	476	505	603	764
• in standby mode of operation according to NEC	W	28.6	29.7	29.7	35.2
Article number		<b>6SL4113-OJA24-0AF0</b>	<b>6SL4113-OJA26-0AF0</b>	<b>6SL4113-OJA27-0AF0</b>	
rated power at 400 V with low overload	kW	37	45	55	
power loss [W] of the CDM or SDOM					
• at the operating point (90/100)	W	1 100	1 240	1 620	
• in standby mode of operation	W	35.2	40.7	40.7	
• at the operating point (90/100) according to NEC	W	990	1 110	1 440	
• in standby mode of operation according to NEC	W	35.2	40.7	40.7	
Article number		<b>6SL4113-OJA08-2AF0</b>	<b>6SL4113-OJA10-2AF0</b>	<b>6SL4113-OJA11-2AF0</b>	<b>6SL4113-OJA12-2AF0</b>
rated power at 400 V with low overload	kW	1.1	1.5	2.2	3
power loss [W] of the CDM or SDOM					
• at the operating point (90/100)	W	85.8	97.3	124	158
• in standby mode of operation	W	23.1	23.1	23.1	23.1
• at the operating point (90/100) according to NEC	W	82.4	86.8	109	132
• in standby mode of operation according to NEC	W	23.1	23.1	23.1	23.1

## SINAMICS G220 built-in and wall-mounted units

## Technical specifications

Article number		6SL4113-0JA13-2AF0	6SL4113-0JA15-2AF0	6SL4113-0JA16-2AF0	6SL4113-0JA17-2AF0
rated power at 400 V with low overload	kW	4	5.5	7.5	11
power loss [W] of the CDM or SDOM					
• at the operating point (90/100)	W	196	254	334	448
• in standby mode of operation	W	23.1	23.1	23.1	28.6
• at the operating point (90/100) according to NEC	W	157	220	271	375
• in standby mode of operation according to NEC	W	23.1	23.1	23.1	28.6

Article number		6SL4113-0JA18-2AF0	6SL4113-0JA20-2AF0	6SL4113-0JA21-2AF0	6SL4113-0JA23-2AF0
rated power at 400 V with low overload	kW	15	18.5	22	30
power loss [W] of the CDM or SDOM					
• at the operating point (90/100)	W	585	560	660	895
• in standby mode of operation	W	28.6	29.7	29.7	35.2
• at the operating point (90/100) according to NEC	W	483	507	607	770
• in standby mode of operation according to NEC	W	28.6	29.7	29.7	35.2

Article number		6SL4113-0JA24-2AF0	6SL4113-0JA26-2AF0	6SL4113-0JA27-2AF0
rated power at 400 V with low overload	kW	37	45	55
power loss [W] of the CDM or SDOM				
• at the operating point (90/100)	W	1 120	1 240	1 630
• in standby mode of operation	W	35.2	40.7	40.7
• at the operating point (90/100) according to NEC	W	1 000	1 120	1 450
• in standby mode of operation according to NEC	W	35.2	40.7	40.7

Article number		6SL4113-2CA16-2AF0	6SL4113-2CA17-2AF0	6SL4113-2CA18-2AF0	6SL4113-2CA20-2AF0	6SL4113-2CA21-2AF0
rated power at 400 V with low overload	kW	7.5	11	15	18.5	22
power loss [W] of the CDM or SDOM						
• at the operating point (90/100)	W	456.3	590.5	781.3	794.3	936.1
• in standby mode of operation	W	32.2	32.2	32.2	32.2	32.2
• at the operating point (90/100) according to NEC	W	366.7	498.6	640.1	717.4	859.2
• in standby mode of operation according to NEC	W	32.2	32.2	32.2	32.2	32.2

Article number		6SL4113-2CA23-2AF0	6SL4113-2CA24-2AF0	6SL4113-2CA26-2AF0	6SL4113-2CA27-2AF0
rated power at 400 V with low overload	kW	30	37	45	55
power loss [W] of the CDM or SDOM					
• at the operating point (90/100)	W	1 156.8	1 441	1 624.2	2 129.8
• in standby mode of operation	W	37.6	37.6	39.2	39.2
• at the operating point (90/100) according to NEC	W	994.2	1 291.4	1 457.4	1 890.6
• in standby mode of operation according to NEC	W	37.6	37.6	39.2	39.2

## SINAMICS G220 built-in and wall-mounted units

### Technical specifications

#### Braking resistors

Article number		<b>JJY:023-15172-0007</b>	<b>JJY:023-16372-0018</b>	<b>JJY:023-43372-0001</b>	<b>JJY:023-42262-0002</b>
electrical resistance of the braking resistor	Ω	68	37	20	7.5
consumed active power rated value	kW	0.11	0.2	0.375	0.93
consumed active power rated value maximum	kW	2.2	4	7.5	18.5
type of electrical connection for power cable		Integrated cable, 2x AWG 16	Integrated cable, 2x AWG 16	Integrated cable, 2x AWG 16	Terminal block
design of the temperature switch		integrated, with cable 2x AWG 22	integrated, with cable 2x AWG 22	integrated, with cable 2x AWG 22	integrated
Degree of protection		IP20 / UL open type	IP20 / UL open type	IP20 / UL open type	IP21

#### Dimensions

width	mm (in)	217 (8.54)	337 (13.27)	337 (13.27)	220 (8.66)
height	mm (in)	60 (2.36)	60 (2.36)	120 (4.72)	180 (7.09)
depth	mm (in)	30 (1.18)	30 (1.18)	30 (1.18)	470 (18.5)
net weight	kg (lb)	0.7 (1.54)	1.1 (2.43)	2 (4.41)	7 (15.43)

Article number		<b>JJY:023-42332-0001</b>	<b>6SL3201-0BE14-3AA0</b>	<b>6SL3201-0BE21-0AA0</b>	<b>6SL3201-0BE21-8AA0</b>
electrical resistance of the braking resistor	Ω	4.5	370	140	75
consumed active power rated value	kW	1.5	0.075	0.2	0.375
consumed active power rated value maximum	kW	30	1.5	4	7.5
type of electrical connection for power cable		Terminal block	Terminal block	Terminal block	Terminal block
design of the temperature switch		integrated	Normally closed contact	Normally closed contact	Normally closed contact
Degree of protection		IP21	IP20 / UL open type	IP20 / UL open type	IP20 / UL open type

#### Dimensions

width	mm (in)	220 (8.66)	105 (4.13)	105 (4.13)	175 (6.89)
height	mm (in)	180 (7.09)	295 (11.61)	345 (13.58)	345 (13.58)
depth	mm (in)	560 (22.05)	100 (3.94)	100 (3.94)	100 (3.94)
net weight	kg (lb)	8.5 (18.74)	1.48 (3.26)	1.8 (3.97)	2.73 (6.02)

Article number		<b>6SL3201-0BE23-8AA0</b>	<b>JJY:023-42262-0001</b>	<b>JJY:023-42402-0001</b>	<b>JJY:023-43402-0001</b>
electrical resistance of the braking resistor	Ω	30	25	15	10
consumed active power rated value	kW	0.925	1.1	1.85	2.75
consumed active power rated value maximum	kW	18.5	22	37	55
type of electrical connection for power cable		Terminal block	Terminal block	Terminal block	Terminal block
design of the temperature switch		Normally closed contact	integrated	integrated	integrated
Degree of protection		IP20 / UL open type	IP21	IP21	IP21

#### Dimensions

width	mm (in)	250 (9.84)	220 (8.66)	220 (8.66)	350 (13.78)
height	mm (in)	490 (19.29)	470 (18.5)	180 (7.09)	630 (24.8)
depth	mm (in)	140 (5.51)	180 (7.09)	610 (24.02)	180 (7.09)
net weight	kg (lb)	6.2 (13.67)	7 (15.43)	9.5 (20.94)	13.5 (29.76)



## SINAMICS G220 built-in and wall-mounted units

### Safety Integrated for SINAMICS G220

#### Overview



The SINAMICS G220 converter features Safety Integrated Functions as standard.

#### **Safety Integrated overview**

The Safety Integrated Functions are implemented electronically and therefore offer short response times and easy handling in comparison to solutions with externally implemented monitoring functions.

The integrated safety functions comply with the requirements of SIL 3 according to IEC 61508 and IEC 61062 and PL e/category 4 according to ISO 13849-1.

No additional license is required for the Basic Functions STO, SS1-t, SS1E-t and SMT. One Safety Extended Runtime license per device is required for the Extended Functions SS1-r, SS1-a, SS1E-r, SS1E-a, SS2, SS2E, SOS, SLS, SSM, SDI and SLA.

Use of the Basic Functions does not require a motor encoder, but use of the Extended Functions does require a Safety-capable encoder connected via DRIVE-CLiQ or SMC20 Sensor Module Cabinet-Mounted.

#### **Controlling the Safety Integrated Functions**

The Safety Integrated Functions are completely integrated into the drive system. They can be activated via fail-safe digital inputs or via PROFINET with PROFIsafe.

The SINAMICS G220 converter has up to three fail-safe digital inputs.

The STO function in the converter is released ex works, and is assigned to the fail-safe digital input F-DI 0. When wiring an emergency stop operating device, the STO function can therefore be used right away with no additional configuration. The F-DI 0 is delivered with a bridge, meaning that the drive can be operated even without wiring an emergency stop operating device.

To comply with the requirements of ISO 13849-1 and IEC 61508 for timely error detection, the fail-safe inputs and switch-off signal paths of the SINAMICS G220 are tested cyclically and automatically during operation. A test stop and consequent shutdown of the drive is therefore not necessary for error detection.

#### OM-SMT Option Module Safe Motor Temperature



OM-SMT Option Module Safe Motor Temperature

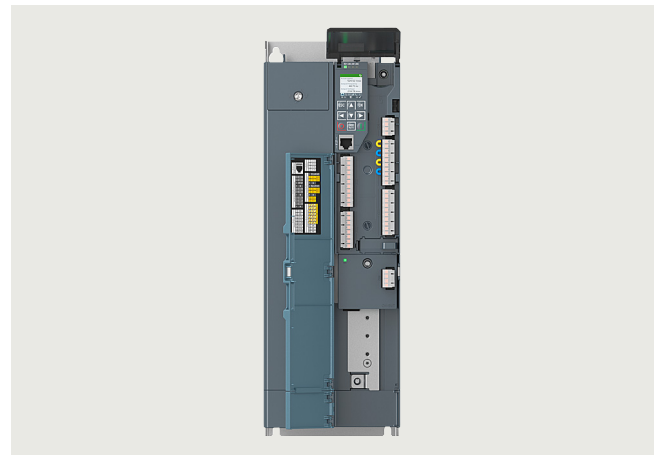

Integrated safety solution: SINAMICS G220 with inserted OM-SMT Option Module Safe Motor Temperature

#### The OM-SMT Option Module (Safe Motor Temperature)

- is suitable for monitoring the temperature of a motor in an explosive atmosphere (ATEX applications).
- is required for the SMT (Safe Motor Temperature) safety function.
- monitors the temperature of motors with two connected PTC temperature sensors for a warning threshold and a shutdown threshold.
- also detects short-circuits and wire breaks in the sensor circuit.
- detects when the limit temperature is exceeded. Once the shutdown threshold is reached, the converter automatically triggers the STO stop function, which prevents the motor from receiving any more energy from the converter; and the temperature can no longer rise.
- is classified for EX II (2) GD. Shutdown is certified for ATEX to SIL 2 in accordance with IEC 61508 and IEC 61062 and PL d, category 3 in accordance with ISO 13849-1.
- is intended for operation in the option slot of the converter. Operation is possible in converters with degree of protection IP20 / UL Open Type and IP55 / UL Type 12.

## SINAMICS G220 built-in and wall-mounted units

Safety Integrated for SINAMICS G220

### Function

Function	Control	Underlying function	Reaction to limit overshoot	Encoder required	License required
<b>Basic functions (no additional license is required)</b>					
<b>STO</b>	<ul style="list-style-type: none"> <li>F-DI</li> <li>PROFIsafe</li> </ul>	–	–	No	No
<b>SS1 time-controlled</b>	<ul style="list-style-type: none"> <li>F-DI</li> <li>PROFIsafe</li> </ul>	Following expiry of the parameterized delay time	–	No	No
<b>SS1E time-controlled</b>	<ul style="list-style-type: none"> <li>F-DI</li> <li>PROFIsafe</li> </ul>	Following expiry of the parameterized delay time	–	No	No
<b>SMT</b>	–	When STO limit temperature exceeded	STO	No	No
<b>Extended functions (an additional license is required)</b>					
<b>SS1 with SBR/SAM</b>	<ul style="list-style-type: none"> <li>F-DI</li> <li>PROFIsafe</li> </ul>	Safe Acceleration Monitor (SAM) or Safe Brake Ramp (SBR) during braking. Following expiry of the parameterized delay time or if the speed falls below the minimum speed limit STO	STO	Yes	Yes
<b>SS1E with SBR/SAM</b>	<ul style="list-style-type: none"> <li>F-DI</li> <li>PROFIsafe</li> </ul>	Safe Acceleration Monitor (SAM) or Safe Brake Ramp (SBR) during braking. Following expiry of the parameterized delay time or if the speed falls below the minimum speed limit STO	STO	Yes	Yes
<b>SS2 time-controlled</b>	<ul style="list-style-type: none"> <li>F-DI</li> <li>PROFIsafe</li> </ul>	Following expiry of the parameterized SOS delay time	–	Yes	Yes
<b>SS2 with SBR/SAM</b>	<ul style="list-style-type: none"> <li>F-DI</li> <li>PROFIsafe</li> </ul>	Safe Acceleration Monitor (SAM) or Safe Brake Ramp (SBR) during braking. Following expiry of the parameterized delay time or if the speed falls below the minimum speed limit SOS	STO	Yes	Yes
<b>SS2E time-controlled</b>	<ul style="list-style-type: none"> <li>F-DI</li> <li>PROFIsafe</li> </ul>	Following expiry of the parameterized SOS delay time	–	Yes	Yes
<b>SS2E with SBR/SAM</b>	<ul style="list-style-type: none"> <li>F-DI</li> <li>PROFIsafe</li> </ul>	Safe Acceleration Monitor (SAM) or Safe Brake Ramp (SBR) during braking. Following expiry of the parameterized delay time or if the speed falls below the minimum speed limit SOS	STO	Yes	Yes
<b>SOS</b>	<ul style="list-style-type: none"> <li>F-DI</li> <li>PROFIsafe</li> </ul>	–	STO	Yes	Yes
<b>SLS</b>	<ul style="list-style-type: none"> <li>F-DI</li> <li>PROFIsafe</li> </ul>	–	STO, SS1, SS1E, SS2, SS2E (can be parameterized)	Yes	Yes
<b>SDI</b>	<ul style="list-style-type: none"> <li>F-DI</li> <li>PROFIsafe</li> </ul>	–	STO, SS1, SS1E, SS2, SS2E (can be parameterized)	Yes	Yes
<b>SSM</b>	<ul style="list-style-type: none"> <li>F-DI</li> <li>PROFIsafe</li> </ul>	–	Signals that the speed has fallen below a specified value	Yes	Yes
<b>SLA</b>	<ul style="list-style-type: none"> <li>F-DI</li> <li>PROFIsafe</li> </ul>	–	STO, SS1, SS1E, SS2, SS2E (can be parameterized)	Yes	Yes

## SINAMICS G220 built-in and wall-mounted units

### Supplementary system components

#### Option Modules > OM-DQ Option Module DRIVE-CLiQ

#### Overview



SINAMICS G220 OM-DQ Option Module DRIVE-CLiQ

The OM-DQ Option Module DRIVE-CLiQ connects the converter to DRIVE-CLiQ modules.

The OM-DQ Option Module DRIVE-CLiQ is intended for operation in the option slot of the converter. Operation is possible in converters with degree of protection IP20 / UL Open Type and IP55 / UL Type 12. The OM-DQ Option Module DRIVE-CLiQ connects the converter to other Option Modules or DRIVE-CLiQ modules that are mounted outside the converter.

#### Selection and ordering data

Description	Article No.
<b>OM-DQ Option Module DRIVE-CLiQ</b>	<b>6SL4950-0AL00-0BA0</b>
• For ordering as a supplementary system component or a spare part	
• For ordering as a part of the converter with an order code	<b>6SL4.....-.....-Z T01</b>

#### Technical specifications

	<b>OM-DQ Option Module DRIVE-CLiQ 6SL4950-0AL00-0BA0</b>
<b>Max. current consumption</b> (at 24 V DC)	0.08 A
<b>Weight</b>	0.075 kg
<b>Operating temperature</b>	-20 ... 60 °C
<b>Transfer rate</b>	100 Mbit/s

## SINAMICS G220 built-in and wall-mounted units

Supplementary system components

Option Modules > OM-IIoT Option Module IIoT

### Overview



SINAMICS G220 OM-IIoT Option Module IIoT

The OM-IIoT Option Module IIoT connects the converter to the Industrial Internet of Things (IIoT).

The OM-IIoT Option Module IIoT is intended for operation in the option slot of the converter. Operation is possible in converters with degree of protection IP20 / UL Open Type and IP55 / UL Type 12. The OM-IIoT Option Module IIoT can be operated outside the option slot via the OM-DQ Option Module DRIVE-CLiQ.

### Selection and ordering data

Description	Article No.
<b>OM-IIoT Option Module IIoT</b>	<b>6SL4950-0AL00-0EA0</b>
• For ordering as a supplementary system component or a spare part	
• For ordering as a part of the converter with an order code	<b>6SL4.....-.....-Z T04</b>

### Technical specifications

	<b>OM-IIoT Option Module IIoT 6SL4950-0AL00-0EA0</b>
<b>Max. current consumption</b> (at 24 V DC)	0.08 A
<b>Weight</b>	0.075 kg
<b>Operating temperature</b>	-20 ... 60 °C

## SINAMICS G220 built-in and wall-mounted units

### Supplementary system components

#### Option Modules > OM-SMT Option Module Safe Motor Temperature

#### Overview



SINAMICS G220 OM-SMT Option Module Safe Motor Temperature

The OM-SMT Option Module Safe Motor Temperature is suitable for monitoring the temperature of a motor in a hazardous atmosphere.

The OM-SMT Option Module Safe Motor Temperature monitors the temperature of motors with two connected PTC temperature sensors. It also detects short-circuits and wire breaks in the sensor circuit.

The OM-SMT Option Module Safe Motor Temperature is intended for operation in the option slot of the converter. Operation is possible in converters with degree of protection IP20 / UL Open Type and IP55 / UL Type 12. The OM-SMT Option Module Safe Motor Temperature can be operated outside the option slot via the OM-DQ Option Module DRIVE-CLiQ.

#### Selection and ordering data

Description	Article No.
<b>OM-SMT Option Module Safe Motor Temperature</b> <ul style="list-style-type: none"> <li>For ordering as a supplementary system component or a spare part</li> <li>For ordering as a part of the converter with an order code</li> </ul>	<b>6SL4950-0AL00-0FA0</b> <b>6SL4.....-.....-Z T05</b>

#### Technical specifications

	OM-SMT Option Module Safe Motor Temperature 6SL4950-0AL00-0FA0
<b>Max. current consumption</b> (at 24 V DC)	0.08 A
<b>Weight</b>	0.075 kg

## SINAMICS G220 built-in and wall-mounted units

### Supplementary system components

#### Smart Drive Interfaces

#### Overview

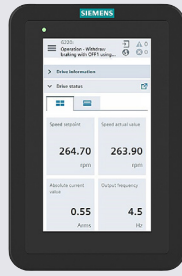
Operator panel	SINAMICS SDI Standard	SINAMICS SDI Pro 5.5"
Description	 <p>With its high-contrast color display (1.4"), menu navigation and the extensive functionality provided by the integrated web server of the connected converter, it is easy to implement commissioning, diagnostics, operator control and monitoring, and service scenarios of the standard drives, for example.</p>	 <p>Thanks to the high-contrast color touch display (5.5"), menu navigation and the extensive functionality provided by the integrated web server of the connected converter, it is easy to implement commissioning, diagnostics, operator control and monitoring, and service scenarios of the standard drives, for example.</p>
Possible applications	<ul style="list-style-type: none"> <li>• Integrated into the SINAMICS G220 converter</li> </ul>	<ul style="list-style-type: none"> <li>• Mountable on the SINAMICS G220<sup>1)</sup> IP55 converter with adapter</li> <li>• Can be mounted in a control cabinet door using a door mounting kit (achievable degree of protection is IP55/UL type 12 enclosure)</li> <li>• The SINAMICS SDI Pro 5.5" can also be used as a handheld device when using the handheld kit.</li> <li>• Wired connection to the converter via the service interface (X127) or PROFIBUS interface (X150)</li> <li>• Direct power supply via the service interface of the converter (X127)</li> </ul>
Quick commissioning without expert knowledge		<ul style="list-style-type: none"> <li>• Easy commissioning of standard applications via quick/advanced commissioning, no knowledge of the parameter structure necessary</li> <li>• Series commissioning with clone function (backup/restore). Backup files are stored directly on the SINAMICS SDI Pro 5.5"</li> <li>• User-defined parameter list with focused, custom parameter selection</li> <li>• Simple on-site commissioning thanks to its use as a handheld</li> </ul>
High degree of operator friendliness and intuitive handling	<ul style="list-style-type: none"> <li>• Intuitive navigation with integrated keyboard</li> <li>• Graphical color display (1.4") to show status values such as pressure or flow rate in the form of scalar values</li> <li>• Status display with freely selectable units to specify physical values</li> <li>• User interface has context-sensitive help, making diagnostics of alarms, for example, possible with minimal documentation</li> <li>• Direct manual operation of the drive with easy switchover between the automatic and manual modes</li> <li>• The following languages are supported: English, French, German, Italian, Spanish, Chinese Simplified</li> </ul>	<ul style="list-style-type: none"> <li>• Intuitive navigation thanks to touch operation</li> <li>• Graphic color touch display (5.5") to show status values such as pressure or flow rate in the form of scalar values</li> <li>• Status display with predefined units</li> <li>• User interface has context-sensitive help, making commissioning or diagnostics of alarms, for example, possible with minimal documentation</li> <li>• Direct manual operation of the drive with the control panel</li> <li>• The SINAMICS SDI Pro 5.5" lets the user easily access a large number of converters (installed in a cabinet, for example) either with an automatically or manually created converter list.</li> <li>• The following languages are supported: English, French, German, Italian, Spanish, Chinese Simplified</li> </ul>
Minimization of maintenance times	<ul style="list-style-type: none"> <li>• Diagnostics using plain text display, can be used locally on-site without documentation</li> <li>• The support function allows for easy access to information about the converter, for which it provides QR code links.</li> <li>• Using the support function, the display can show a QR code representing the IP address of the service/fieldbus interface currently configured on the converter. By scanning the code (for example, with a smartphone), the user can easily access the integrated web server of the converter.</li> <li>• Simple cloning of the SINAMICS SDI default settings with the converter's backup/restore function.</li> <li>• Updating of the SINAMICS SDI standard function with a drive firmware upgrade.</li> </ul>	<ul style="list-style-type: none"> <li>• Diagnostics using plain text display; can be used locally on-site without documentation</li> <li>• The support function allows for easy access to information about the SINAMICS SDI Pro and the converter, for which it provides QR code links.</li> <li>• Simple cloning of the SDI Pro settings with the backup/restore function of the Panel.</li> <li>• Thanks to the USB C interface on the SINAMICS SDI Pro, the Panel can be upgraded to the latest features. The upgrade only affects the internal functionality of the SINAMICS SDI Pro. The user interface of the converter is not affected. It is provided by the respective converter.</li> </ul>

<sup>1)</sup> Release for SINAMICS S200 and SINAMICS S210 (6SL5...) available soon.



# SINAMICS G220 built-in and wall-mounted units

## Supplementary system components

### Smart Drive Interfaces > SINAMICS SDI Standard

#### Overview

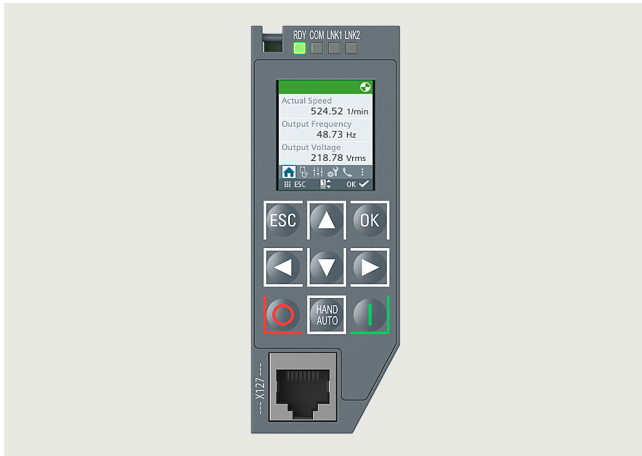

SINAMICS G220 SDI Standard

The SINAMICS SDI Standard is a highly user-friendly Operator Panel for the SINAMICS G220. The SDI Standard supports newcomers and drive experts alike with essential tasks locally on the device. Thanks to its high-contrast 1.4" color display and membrane keyboard, the device can assist with diagnosing faults in plain text, operation and monitoring, and with maintenance and servicing of the converter on site.

The user interface to the converter is provided by the converter's built-in web server. The technology in the SDI Standard gives it access to select functions of the web server.

This includes:

- Home page with selected display values (values are configurable)

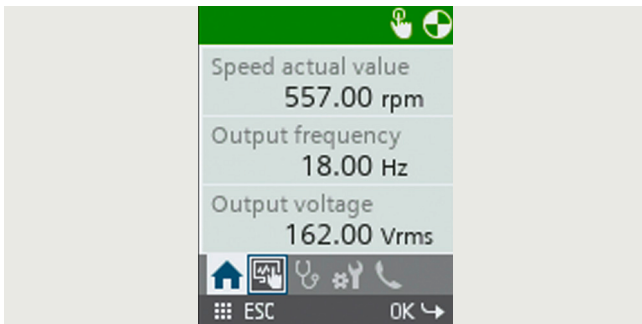

- Operate motor in manual operation

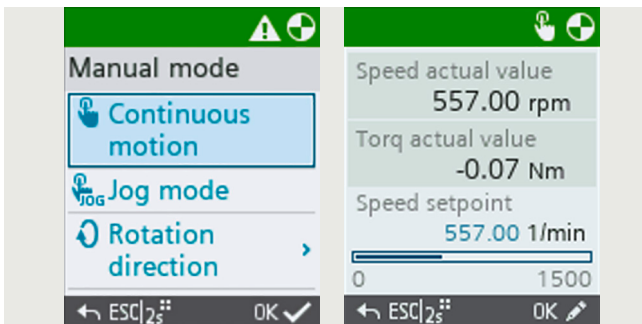

- Diagnose alarms in plain text and view fault cause/remedy messages

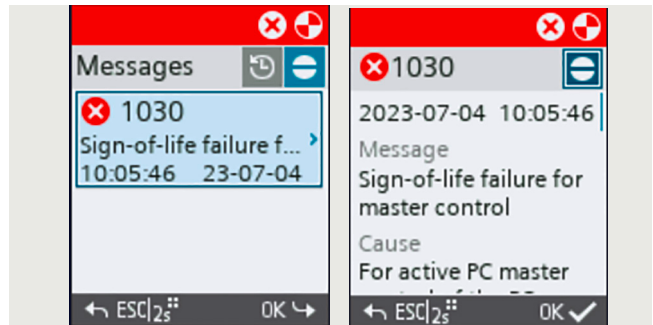

- System settings to configure the web server, converter interfaces, date and time and display settings (brightness, backlight timer) as well as the user interface language

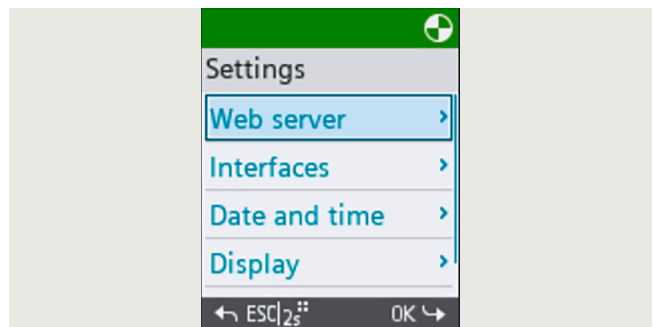

- Support page with scannable information (QR code) for the configured IP address of the service interface and PROFINET interface (X127 / X150) and for the individual components of the SINAMICS G220 drive.

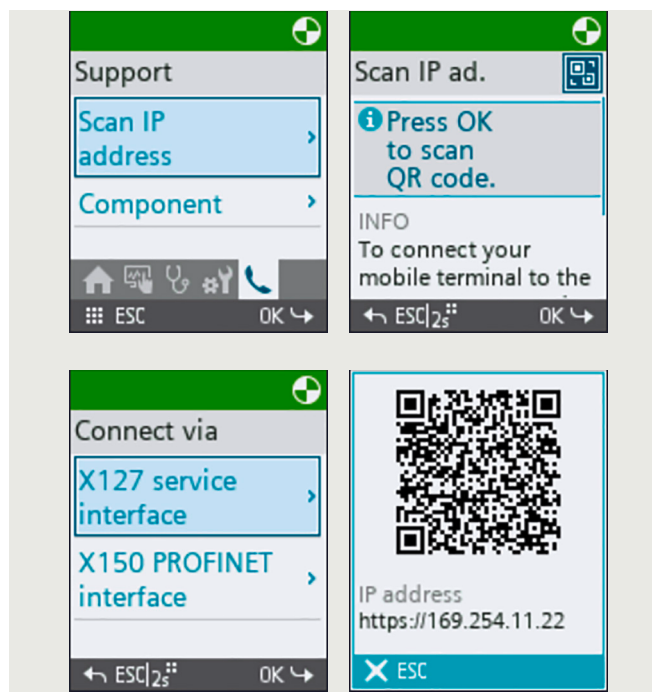

## SINAMICS G220 built-in and wall-mounted units

### Supplementary system components

#### Smart Drive Interfaces > SINAMICS SDI Standard

#### Technical specifications

	SINAMICS SDI Standard
<b>Display</b>	1.4" color display
• Resolution	128 × 160 pixels
<b>User languages</b>	German, English, French, Italian, Spanish, Chinese Simplified
<b>Converter service interface</b>	X127 service interface (1 RJ45)
<b>Ambient temperature</b>	
• During storage	-25 ... +55 °C (-13 ... +131 °F)
• During transport	-40 ... +70 °C (-40 ... +158 °F)
• During operation	-20 ... +60 °C (-4 ... +140 °F)
- without power reduction, max.	+40 °C (+104 °F)
<b>Environmental class/harmful chemical substances</b>	
• Operation	
<b>Air humidity</b>	Relative air humidity < 95 %, non-condensing
<b>Degree of protection</b>	IP20/IP55
<b>Certificate of suitability</b>	UL, cUL, CE, EAC, REACH, RoHS II, Green Passport

# SINAMICS G220 built-in and wall-mounted units

## Supplementary system components

Smart Drive Interfaces > SINAMICS SDI Pro 5.5"

### Overview

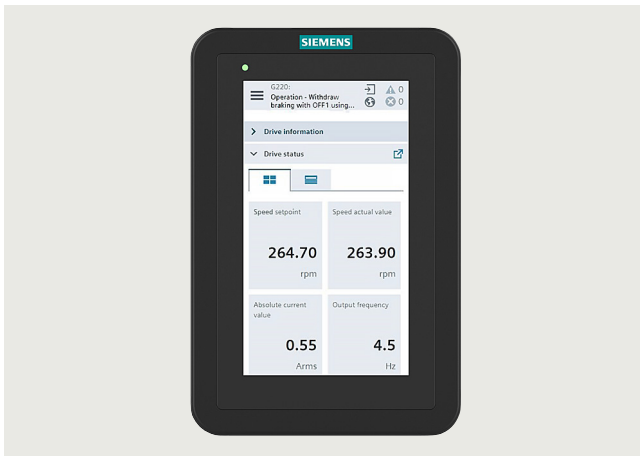

SINAMICS SDI Pro 5.5"

The SINAMICS SDI Pro 5.5" represents a powerful and user-friendly Operator Panel for SINAMICS G220, SINAMICS S200<sup>1)</sup> and SINAMICS S210 (6SL5...)<sup>1)</sup>. The SDI Pro supports both newcomers and drive experts. Thanks to its touch interface and high-contrast 5.5" color display, it goes hand-in-glove for commissioning, diagnostics, operator control and monitoring as well as on-site maintenance and servicing of converters.

The user interface to the converter is provided by the converter's built-in web server. The technology of the SDI Pro grants full access to the functionality of the web server.

The supported web server functions pertaining to each converter can be found here:

- SINAMICS G220 ⇒ For more information on web server functions, see [SINAMICS web server for SINAMICS G220](#).
- SINAMICS S200<sup>1)</sup> ⇒ For more information on web server functions, see [SINAMICS web server for SINAMICS S200](#).
- SINAMICS S210 (6SL5...)<sup>1)</sup> ⇒ For more information on web server functions, see [SINAMICS web server for SINAMICS S210 \(6SL5...\)](#).

In addition, the SDI Pro offers its own configuration interface with the following settings options:

- SDI Pro main menu

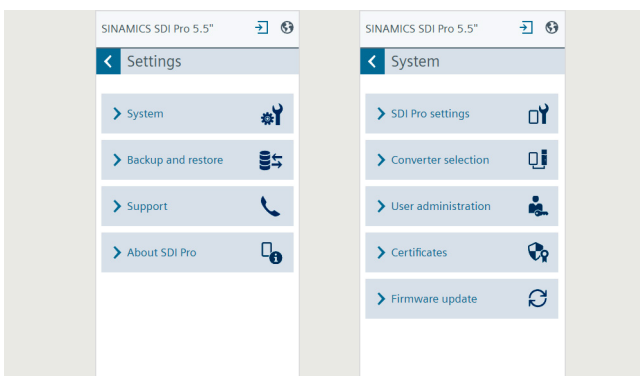

- Set the SDI Pro system settings such as user interface language, real-time clock, interface settings, display settings, change background image of the home screen



- Back up and restore the SDI Pro device settings

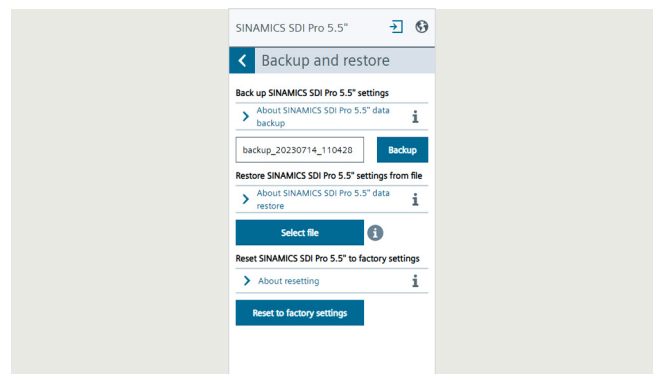

- Access product-specific information (e.g. manuals, downloads, FAQs) and information on SDI Pro (e.g. currently installed firmware version, security notifications)

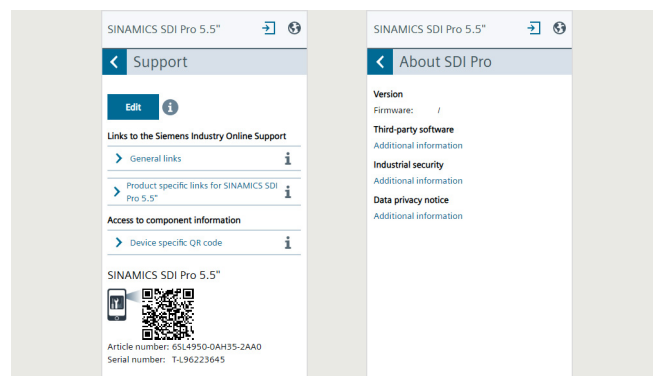

The additional available options in the form of the SINAMICS SDI Pro 5.5" handheld kit and SINAMICS SDI Pro 5.5" door mounting kit extend the operating range of the device. With the SDI Pro 5.5" handheld kit, the device can be equipped with a rubber oversheath for mobile use. The SINAMICS SDI Pro 5.5" door mounting kit enables the SINAMICS SDI Pro to be installed in control cabinet doors.

<sup>1)</sup> Release for SINAMICS S200 and SINAMICS S210 (6SL5...) available soon.

# SINAMICS G220 built-in and wall-mounted units

## Supplementary system components

### Smart Drive Interfaces > SINAMICS SDI Pro 5.5"

#### Selection and ordering data

Description	Article No.
<b>SINAMICS SDI Pro 5.5"</b> <sup>2) 4) 5)</sup> for use with SINAMICS G220 SINAMICS S200 <sup>1)</sup> SINAMICS S210 (6SL5... <sup>1)</sup> Operating languages: German, English, French, Italian, Spanish, Chinese Simplified	<b>6SL4950-0AH35-2AA0</b>
<b>Accessories</b>	
<b>SINAMICS SDI Pro 5.5" handheld kit</b> <sup>2) 5)</sup> for use with the SINAMICS SDI Pro 5.5" Included in the scope of delivery: • Handheld housing • Ethernet connecting cable Length 3 m (9.84 ft), can be used to connect a SINAMICS SDI Pro 5.5" with a converter	<b>6SL4950-0AH65-0AA0</b>
<b>SINAMICS SDI Pro 5.5" door mounting kit</b> <sup>2) 5)</sup> for mounting a SINAMICS SDI Pro 5.5" in control cabinet doors with metal thicknesses of 1 ... 3 mm (0.04 ... 0.12 in) Degree of protection IP55 Included in the scope of delivery: • Metal plate for installing the SINAMICS SDI Pro 5.5" • Fixing accessories	<b>6SL4950-0AH55-0AA0</b>
<b>SINAMICS IP55 panel mounting frame</b> <sup>5)</sup> for SINAMICS G220 Included in the scope of delivery: • SINAMICS IP55 panel mounting frame • Ethernet connecting cable, length approx. 15 cm (5.91 in)	<b>6SL4950-0AH75-0AA0</b>
<b>Bundle SINAMICS SDI Pro 5.5" with            SINAMICS IP55 panel mounting frame</b> <sup>5)</sup> for SINAMICS G220 Included in the scope of delivery: • SINAMICS SDI Pro 5.5" • SINAMICS IP55 panel mounting frame • Ethernet connecting cable, length approx. 15 cm (5.91 in)	<b>6SL4950-0AH45-0AA0</b>
<b>IE TP Cord RJ45/RJ45</b> <sup>3)</sup> Patch cable, available fully assembled • With 4 x 2 cores for 10/100/1000 Mbps Ethernet • Small cable diameter • Cat6 <sub>A</sub> (4 x 2) of the ISO/IEC 11801 and EN 50173 international cabling standards 0.3 m 0.5 m 1 m 2 m 3 m 4 m 6 m 10 m 15 m 20 m 25 m 30 m	<b>6XV1870-3QE30</b> <b>6XV1870-3QE50</b> <b>6XV1870-3QH10</b> <b>6XV1870-3QH20</b> <b>6XV1870-3QH30</b> <b>6XV1870-3QH40</b> <b>6XV1870-3QH60</b> <b>6XV1870-3QN10</b> <b>6XV1870-3QN15</b> <b>6XV1870-3QN20</b> <b>6XV1870-3QN25</b> <b>6XV1870-3QN30</b>

<sup>1)</sup> For information on updates to the SINAMICS SDI Pro 5.5", see [www.siemens.com/sinamics-sdi-pro-dl](http://www.siemens.com/sinamics-sdi-pro-dl)

<sup>2)</sup> The Ethernet connection cable to connect the SDI Pro to the service interface of the converter (X127) or the PROFINET interface (X150) must be ordered separately. To use the operator panel without an additional power supply at the service interface of the converter (X127; point-to-point connection), an 8-wire RJ45 Ethernet cable is required. Pre-assembled cables can be ordered as an accessory.

<sup>3)</sup> For applications where the space behind the SINAMICS SDI Pro 5.5" is very limited, a cable with angled connectors can be used. Such cables can be purchased from HARTING under the order number 09 48 858 5745 050. For information on HARTING cables visit [www.harting.com](http://www.harting.com).

<sup>4)</sup> Release for SINAMICS S200 and SINAMICS S210 (6SL5...) available soon.

<sup>5)</sup> Available soon.

#### Benefits

- User interface
  - Intuitive user interface for the drive provided by the converter itself
  - High-contrast 5.5" color touch display
  - SINAMICS SDI Pro device design open for future function expansions (e.g. device functions, languages)
  - Easily upgradable to latest features via USB C interface
- Commissioning
  - Easy commissioning of the connected converter via the Quick/Advanced Commissioning Wizard. Neither variant requires expert knowledge of converter parameters.
  - Quick commissioning gives the user simple and fast access to all the basic parameters required to commission simple applications.
  - Advanced commissioning provides the parameters required to commission more complex applications, dispensing with the need to switch between different areas within the user interface.
  - Fast series commissioning of frequency converters thanks to cloning function (backup/restore)
  - For quicker access right on the SDI Pro, the names of the backup files you wish to create can be entered or modified with the on-screen keyboard.
  - Context-sensitive help functions provide support for the user during commissioning.
  - Simple local commissioning on-site using the handheld kit
- Operator control and monitoring
  - Simple, individual local drive control (start/stop, setpoint value specification, change in direction of rotation)
  - Actual values from the converter are displayed clearly. You can change the parameters you wish to monitor depending on the requirement.
- Diagnostics
  - Rapid diagnostics thanks to on-site plain text display
  - Integrated plain text help function for local display and resolution of fault messages
- Service and Support function
  - Input/output of a service contact person
  - Easy access to component information via QR code shown on the display
  - Quick access to product information, documentation, FAQs using mobile devices (e.g. smartphones, tablets) by scanning a QR code generated on the SDI Pro
  - Optional scanning and evaluation of the QR code with the Industry Online Support app (<https://support.industry.siemens.com/cs/ww/en/sc/2067>)
  - Simple cloning of specific settings of the SINAMICS SDI Pro such as the language setting, backlight timer, date/time settings, interface settings (IP address), list of available converters, user administration of the SDI Pro. Settings made once can thus be transferred easily to many other SINAMICS SDI Pro 5.5" devices.
  - Firmware upgrade for the SINAMICS SDI Pro 5.5"  
 The SDI Pro can be updated and expanded with the integrated USB C port.  
 Data can be transferred from a PC to the device for future expansions. Furthermore, the USB interface allows user languages and firmware updates<sup>1)</sup> that will become available in future to be downloaded.
- Management of users allowed to have access to the SDI Pro settings (UMAC)
- Management of certificates for encrypted communication to the converter (https)

## SINAMICS G220 built-in and wall-mounted units

### Supplementary system components

#### Smart Drive Interfaces > SINAMICS SDI Pro 5.5"

#### Integration

- Flexible deployment in point-to-point and network configurations
  - The SDI Pro can either be connected to the service interface (X127) or the PROFINET interface (X150) of the converter.
  - SDI Pro can be directly supplied with power via the converter service interface. An external power supply is not required.<sup>1)</sup>
- If the SDI Pro is operated in a network with  $n$  converters ( $1 < n \leq 20$ ), the converters can be accessed in a flexible way via a drive list. As such, a wide range of converters can be operated or diagnosed via an SDI Pro, for instance. The drive list can be conveniently created on the SDI Pro either automatically or manually.

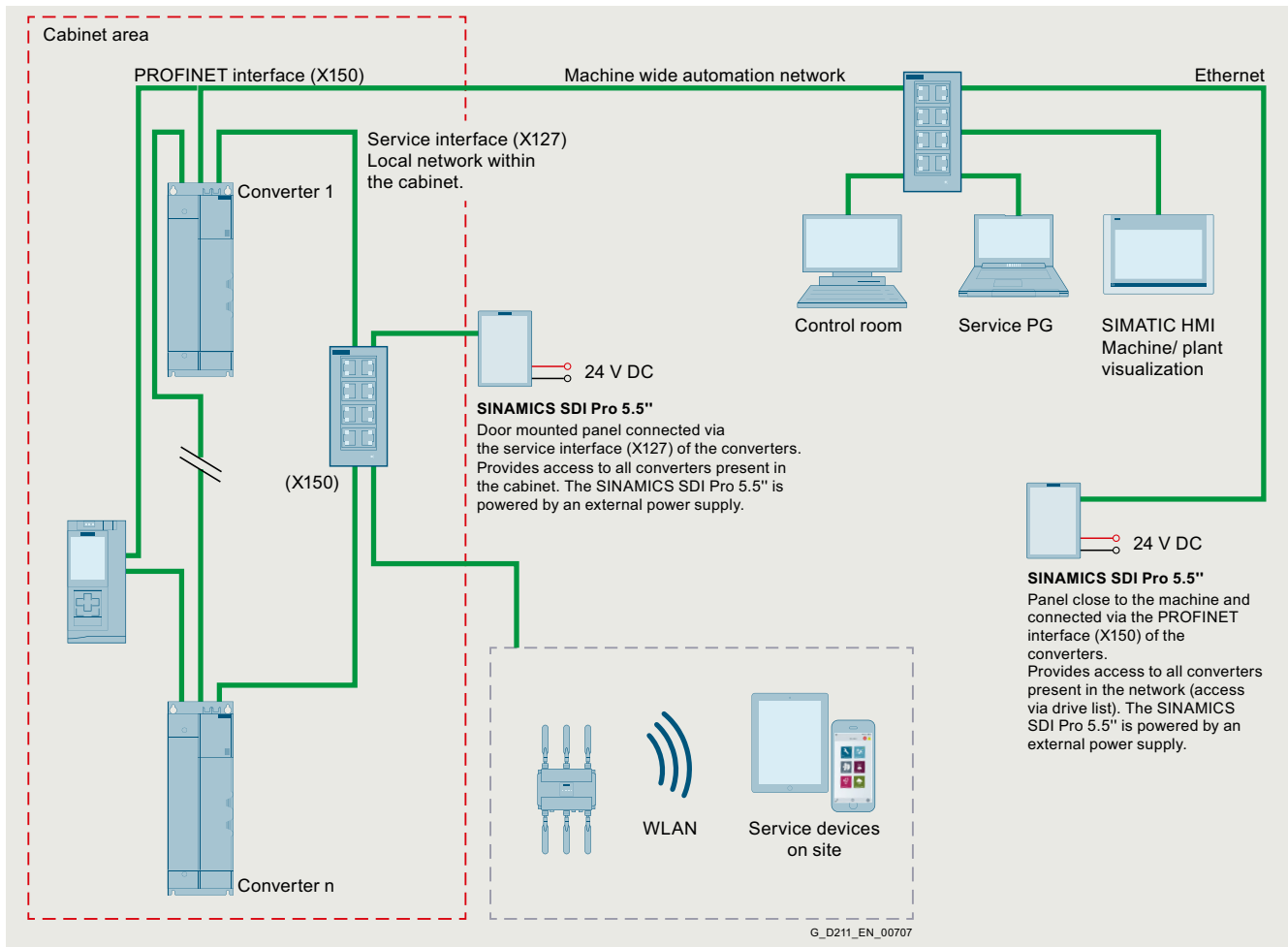

Application example in which multiple converters in a control cabinet can be reached with one SINAMICS SDI Pro

<sup>1)</sup> To use the operator panel without an additional power supply at the service interface of the converter (X127; point-to-point connection), an 8-wire RJ45 Ethernet cable is required. Pre-assembled cables can be ordered as an accessory.

## SINAMICS G220 built-in and wall-mounted units

### Supplementary system components

#### Smart Drive Interfaces > SINAMICS SDI Pro 5.5"

#### Technical specifications

SINAMICS SDI Pro 5.5" 6SL4950-0AH35-2AA0	
<b>Display</b> • Resolution	High-contrast color display 320 × 580 pixels
<b>Operator panel</b>	Touch display
<b>User languages</b>	German, English, French, Italian, Spanish, Chinese Simplified
<b>Power supply</b>	20 ... 29 V DC 24 V DC via the RJ45 (8-core) X127 cable connection from the converter <sup>1)</sup> or external power supply via the external power supply terminals on the Operator Panel
<b>Current, max.</b>	300 mA
<b>Ambient temperature</b> • During transport and storage • During operation	-40 ... +70 °C (-40 ... +158 °F) When using the SINAMICS SDI Pro 5.5" handheld kit: -20 ... +55 °C (-4 ... +131 °F) If installed with the SINAMICS SDI Pro 5.5" door mounting kit: -20 ... +55 °C (-4 ... +131 °F)
<b>Air humidity</b>	Relative air humidity < 95 %, non-condensing
<b>Environmental class/harmful chemical substances</b> • Operation	Class 3C3 per IEC 60721-3-3: 2002
<b>Degree of protection</b>	IP20 on the rear side or when in use with the SINAMICS SDI Pro 5.5" handheld kit IP55 on the front side, mounted with the SINAMICS SDI Pro 5.5" door mounting kit
<b>Dimensions (H × W × D)</b>	167 mm × 111 mm × 16.1 mm (6.57 in × 4.37 in × 0.63 in)
<b>Weight, approx.</b>	0.275 kg (0.61 lb)
<b>Certificate of suitability</b>	CE, UKCA, RCM, cULus, EAC, KC-REM-S49-SINAMICS

SINAMICS SDI Pro 5.5" handheld kit 6SL4950-0AH65-2AA0	
<b>Ambient temperature</b> • During transport and storage	-40 ... +70 °C (-40 ... +158 °F)
<b>Air humidity</b>	Relative air humidity < 95 %, non-condensing
<b>Degree of protection</b>	IP20
<b>Weight, approx.</b>	0.265 kg (0.58 lb)

SINAMICS SDI Pro 5.5" door mounting kit 6SL4950-0AH55-0AA0	
<b>Ambient temperature</b> • During transport and storage	-40 ... +70 °C (-40 ... +158 °F)
<b>Air humidity</b>	Relative air humidity < 95 %, non-condensing
<b>Degree of protection</b>	IP20 on the rear side or inside of the cabinet IP55 on the front side, mounted with the SINAMICS SDI Pro 5.5" door mounting kit
<b>Dimensions</b> • Door mounting kit dimensions	Cabinet cutout: 93 mm × 153 mm (3.66 in × 6.02 in), Screws: M4 × 20, 6 pcs., Tightening torque: 0.1 Nm (0.89 lbf-in) / M3 × 6, 2 pcs., Tightening torque: 1.2 Nm (10.6 lbf-in)
<b>Weight, approx.</b>	0.214 kg (0.47 lb)

SINAMICS IP55 Panel mounting frame 6SL4950-0AH75-0AA0	
<b>Ambient temperature</b> • During transport and storage	-40 ... +70 °C (-40 ... +158 °F)
<b>Air humidity</b>	Relative air humidity < 95 %, non-condensing
<b>Degree of protection</b>	IP55, including the SINAMICS SDI Operator Panel
<b>Dimensions</b> • Mounting frame dimensions	180 mm × 150 mm × 35 mm (7.09 in × 5.91 in × 1.38 in), Screws: M4 × 20, 4 pcs., Tightening torque: 1.2 Nm (10.6 lbf-in)
<b>Weight, approx.</b>	0.405 kg (0.89 lb) + 0.275 kg (0.61 lb) if the SINAMICS SDI Pro Operator Panel is inserted in the mounting frame

<sup>1)</sup> The Ethernet connection cable to connect the SDI Pro to the service interface of the converter (X127) or the PROFINET interface (X150) must be ordered separately.  
To use the operator panel without an additional power supply at the service interface of the converter (X127; point-to-point connection), an 8-wire RJ45 Ethernet cable is required. Pre-assembled cables can be ordered as an accessory.



## SINAMICS G220 built-in and wall-mounted units

### Supplementary system components

Smart Drive Interfaces > SINAMICS SDI Pro 5.5"

#### Accessories

##### SINAMICS SDI Pro 5.5" handheld kit



SINAMICS SDI Pro 5.5" with handheld kit

A handheld kit can be ordered to assist with using the SINAMICS SDI Pro 5.5" while on the go. It contains a rubber housing and a 3 m long Ethernet connecting cable.

##### SINAMICS IP55 Panel mounting frame

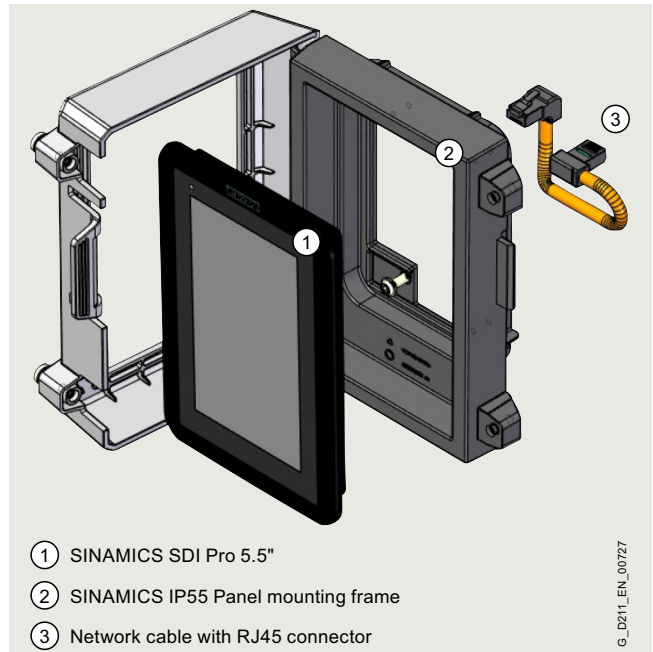

- ① SINAMICS SDI Pro 5.5"
- ② SINAMICS IP55 Panel mounting frame
- ③ Network cable with RJ45 connector

G\_D211\_EN\_00727

SINAMICS IP55 Panel mounting frame

The SINAMICS IP55 Panel mounting frame is designed so that the SINAMICS SDI Pro Operator Panel can be connected to the IP55 converter while retaining the IP55 degree of protection of the converter.

##### SINAMICS SDI Pro 5.5" door mounting kit

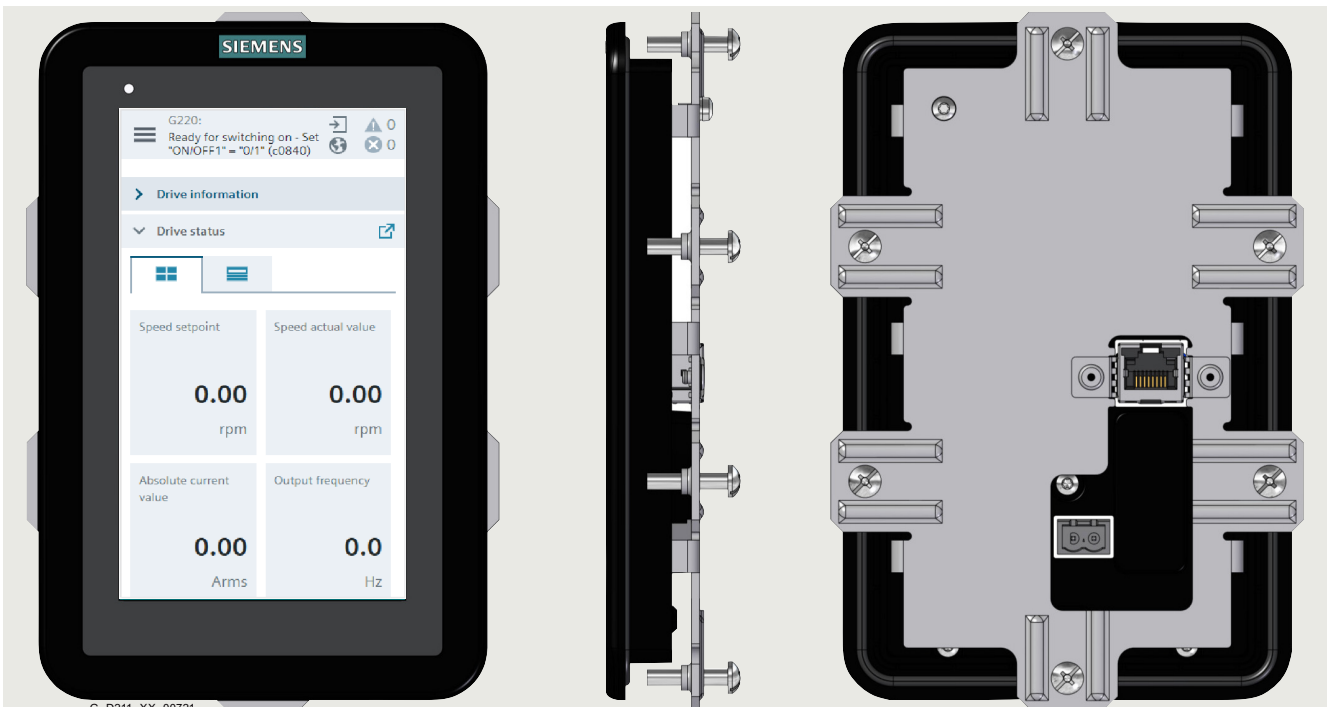

G\_D211\_XX\_00721

With the optional SINAMICS SDI Pro 5.5" door mounting kit, a SINAMICS SDI Pro 5.5" can be easily installed in a control cabinet door in just a few steps. The door mounting kit includes a metal plate for installing the SINAMICS SDI Pro 5.5" e.g. in a cabinet cutout. <sup>1)</sup> In case of door mounting with the SDI Pro 5.5" Operator Panel, the degree of protection IP55/UL type 12 enclosure is achieved for the front side.

<sup>1)</sup> The Ethernet connection cable to connect the SDI Pro to the service interface of the converter (X127) or the PROFINET interface (X150) must be ordered separately.

To use the operator panel without an additional power supply at the service interface of the converter (X127; point-to-point connection), an 8-wire RJ45 Ethernet cable is required. Pre-assembled cables can be ordered as an accessory.



## SINAMICS G220 built-in and wall-mounted units

### Supplementary system components

#### SINAMICS Smart Adapter

##### Overview



SINAMICS Smart Adapter

SINAMICS Smart Adapter is a Wi-Fi solution for engineering, service and maintenance tasks for the next generation of SINAMICS converters SINAMICS S200, SINAMICS S210 (6SL5...) and SINAMICS G220. The adapter is designed to be plugged into and powered from the service interface (X127) on the converter.

##### Benefits

- Wireless access to the converter-integrated web server via mobile users device
- Wireless access with SINAMICS Startdrive to the SINAMICS converters
- Portable and compact Wi-Fi solution for engineering, service and maintenance tasks for the next generation of SINAMICS converters SINAMICS S200, SINAMICS S210 (6SL5...) and SINAMICS G220
- Advanced security technology
- Plug and Play interface for easy connectivity
- User friendly

##### Application

SINAMICS Smart Adapter is used in general industrial applications as an engineering solution for quick commissioning and service.

The adapter is especially valuable in areas, which are difficult to access due to their mechanical mounting locations. The use of SINAMICS Smart Adapter avoids cable clutter and tripping points during commissioning and service tasks and therefore prevents from occasional accidents.

##### Function

- Easy and quick service and commissioning via a wireless solution using the converter-integrated web server
- Interface that is suitable for the next generation of SINAMICS converters SINAMICS S200, SINAMICS S210 (6SL5...) and SINAMICS G220 allows power supply of SINAMICS Smart Adapter directly from the converter.
- Advanced security with WPA3 protocol

##### Selection and ordering data

Description	Article No.
<b>SINAMICS Smart Adapter</b> Wi-Fi solution for the next generation of SINAMICS converters SINAMICS S200, SINAMICS S210 (6SL5...) and SINAMICS G220	<b>6SL4950-0AJ00-0AA0</b>

##### Technical specifications

<b>SINAMICS Smart Adapter 6SL4950-0AJ00-0AA0</b>	
<b>Supported operating systems</b>	Apple iOS (from 12.2), Android, Microsoft Windows, Mac OS (from 10.15)
<b>Recommended browsers</b>	Google Chrome (from 69.0), Microsoft Edge (from 80.0), Safari, Opera (from 56.0)
<b>Ambient temperature</b>	
• During storage and transport	-40 °C ... +70 °C (-40 ... +158 °F)
• During operation	-10 °C ... +40 °C (-40 ... +104 °F)
<b>Humidity</b>	< 95 %, without condensation
<b>Rated voltage</b>	24 V DC
<b>Wireless technology and frequency range <sup>1)</sup></b>	
• At 2.4G:	Wi-Fi 2400 MHz ... 2483.5 MHz
• At 5G:	Wi-Fi 5150 MHz ... 5250 MHz
<b>Wireless modulation type</b>	
• At 2.4G:	802.11 b/g/n
• At 5G:	802.11 a/n
<b>Maximum output power (EIRP)</b>	
• At 2.4G:	17.66 dBm
• At 5G:	14.50 dBm
<b>Type of modulation</b>	DSSS (DBPSK, DQPSK, CCK), OFDM (BPSK, QPSK, 16QAM, 64QAM)
<b>Maximum wireless communication distance</b>	50 m (164 ft)
<b>Maximum antenna gain</b>	
• At 2.4G:	1.2 dBi
• At 5G:	1.6 dBi
<b>Maximum radio frequency output power</b>	
• At 2.4G:	18 dBm
• At 5G:	15 dBm
<b>Degree of protection</b>	IP20/UL Open Type
<b>Dimensions</b>	
• Width	30 mm (1.18 in)
• Height	200 mm (7.87 in)
• Depth	18 mm (0.71 in)
<b>Weight, approx.</b>	0.032 kg (0.071 lb)
<b>Compliance with standards</b>	CE, UKCA, UL, CRC, IMDA, NBTC, KCC, NCC, ICASA, SDPPI, UkrCEPRO, JRF, RED, FCC, IC, WPC, ANATEL, TRA, MIC, SRRC, RCM, ENACOM, SUBTEL, MTC, SDOC, MOC

<sup>1)</sup> The actual frequency range may vary depending on market.

# SINAMICS G220 built-in and wall-mounted units

## Supplementary system components

### SINAMICS Smart Adapter

#### Integration

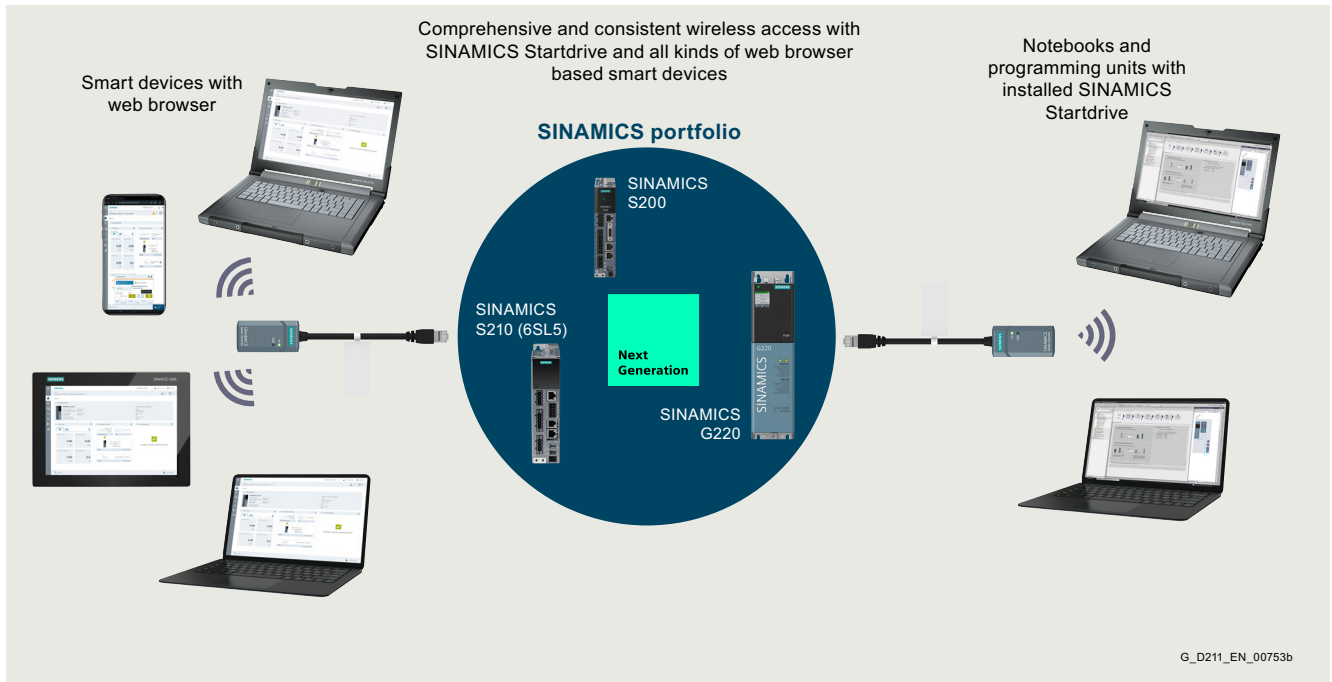

Wireless access with SINAMICS Startdrive via SINAMICS Smart Adapter

## SINAMICS G220 built-in and wall-mounted units

### Supplementary system components

#### Encoder system connection > SMC10 Sensor Module Cabinet-Mounted

##### Overview



SMC10 Sensor Module Cabinet-Mounted

The SMC10 Sensor Module Cabinet-Mounted is required to evaluate the encoder signals of motors without a DRIVE-CLiQ interface. External encoders can also be connected via the SMC10.

The following encoder signals can be evaluated:

- 2-pole resolver
- Multi-pole resolver

##### Design

The SMC10 Sensor Module Cabinet-Mounted features the following connections and interfaces as standard:

- 1 encoder connection including motor temperature sensing (KTY84-130, Pt1000<sup>1)</sup> or PTC) via SUB-D connector
- 1 DRIVE-CLiQ interface
- 1 connection for the electronics power supply via the 24 V DC supply connector
- 1 PE/protective conductor connection

The status of the SMC10 Sensor Module Cabinet-Mounted is indicated via a multi-color LED.

The SMC10 Sensor Module Cabinet-Mounted can be snapped onto a TH 35 standard mounting rail according to EN 60715 (IEC 60715).

The signal cable shield is connected via the encoder system connector and can also be connected to the SMC10 Sensor Module Cabinet-Mounted via a shield connection terminal, e.g. Phoenix Contact type SK8 or Weidmüller type KLBÜ CO 1. The shield connection terminal must not be used as a strain relief mechanism.

##### Integration

SMC10 Sensor Modules Cabinet-Mounted communicate via DRIVE-CLiQ with selected devices e.g. SINAMICS S110/S120/S150 Control Units and SINAMICS G220 converters (from firmware V6.4) with OM-DQ Option Module DRIVE-CLiQ.

##### Selection and ordering data

Description	Article No.
<b>SMC10 Sensor Module Cabinet-Mounted</b> Without DRIVE-CLiQ cable	<b>6SL3055-0AA00-5AA3</b>
<b>Accessories for re-ordering</b>	
<b>Dust protection blanking plugs</b> (50 units) For DRIVE-CLiQ port	<b>6SL3066-4CA00-0AA0</b>

For the SINAMICS S150 and SINAMICS S120 Cabinet Modules, the SMC10 Sensor Module Cabinet-Mounted can be ordered as an option by specifying order code **K46**.

##### Technical specifications

	<b>SMC10 Sensor Module Cabinet-Mounted</b> 6SL3055-0AA00-5AA3
<b>Current requirement, max.</b> at 24 V DC, without taking encoder into account	0.2 A
• Conductor cross-section, max.	2.5 mm <sup>2</sup>
• Fuse protection, max.	20 A
<b>Power loss, max.</b>	10 W
<b>Encoders which can be evaluated</b>	<ul style="list-style-type: none"> <li>• 2-pole resolver</li> <li>• Multi-pole resolver</li> </ul>
• Excitation voltage, rms	4.1 V
• Excitation frequency	5 ... 16 kHz depending on the current controller clock cycle of the Motor Module or Power Module
• Transformation ratio	0.5
• Encoder frequency, max.	2 kHz (120000 r/min) depending on the number of resolver pole pairs and current controller clock cycle of the Motor Module or Power Module
• Signal subdivision (interpolation), max.	16384 times (14 bits)
• Cable length to encoder, max.	130 m (427 ft)
<b>PE connection</b>	M4 screw
<b>Dimensions</b>	
• Width	30 mm (1.18 in)
• Height	150 mm (5.91 in)
• Depth	111 mm (4.37 in)
<b>Weight, approx.</b>	0.45 kg (0.99 lb)
<b>Certificate of suitability</b>	cULus

<sup>1)</sup> The Pt1000 sensor is not supported when combined with a Control Unit CU305.

## SINAMICS G220 built-in and wall-mounted units

### Supplementary system components

#### Encoder system connection > SMC20 Sensor Module Cabinet-Mounted

### Overview



SMC20 Sensor Module Cabinet-Mounted

The SMC20 Sensor Module Cabinet-Mounted is required to evaluate the encoder signals of motors without a DRIVE-CLiQ interface. External encoders can also be connected via the SMC20.

The following encoder signals can be evaluated:

- Incremental encoder sin/cos 1 V<sub>pp</sub>
- Absolute encoder EnDat 2.1
- SSI encoder with incremental signals sin/cos 1 V<sub>pp</sub> (firmware version 2.4 and later)

The motor temperature can also be sensed using a PTC thermistor KTY84-130, Pt1000<sup>1)</sup> or PTC.

### Design

The SMC20 Sensor Module Cabinet-Mounted features the following connections and interfaces as standard:

- 1 encoder connection including motor temperature sensing (KTY84-130, Pt1000<sup>1)</sup> or PTC) via SUB-D connector
- 1 DRIVE-CLiQ interface
- 1 connection for the electronics power supply via the 24 V DC supply connector
- 1 PE/protective conductor connection

The status of the SMC20 Sensor Module Cabinet-Mounted is indicated via a multi-color LED.

The SMC20 Sensor Module Cabinet-Mounted can be snapped onto a TH 35 standard mounting rail according to EN 60715 (IEC 60715).

The signal cable shield is connected via the encoder system connector and can also be connected to the SMC20 Sensor Module Cabinet-Mounted via a shield connection terminal, e.g. Phoenix Contact type SK8 or Weidmüller type KLBÜ CO 1. The shield connection terminal must not be used as a strain relief mechanism.

### Integration

SMC20 Sensor Modules Cabinet-Mounted communicate via DRIVE-CLiQ with selected devices e.g. SINAMICS S110/S120/S150 Control Units and SINAMICS G220 converters with OM-DQ Option Module DRIVE-CLiQ.

### Selection and ordering data

Description	Article No.
<b>SMC20 Sensor Module Cabinet-Mounted</b>	<b>6SL3055-0AA00-5BA3</b>
Without DRIVE-CLiQ cable	
<b>Accessories for re-ordering</b>	
<b>Dust protection blanking plugs</b> (50 units)	<b>6SL3066-4CA00-0AA0</b>
For DRIVE-CLiQ port	

For the SINAMICS S150 and SINAMICS S120 Cabinet Modules, the SMC20 Sensor Module Cabinet-Mounted can be ordered as an option by specifying order code **K48**.

### Technical specifications

	<b>SMC20 Sensor Module Cabinet-Mounted 6SL3055-0AA00-5BA3</b>
<b>Power requirement, max.</b> at 24 V DC, without taking encoder into account	0.2 A
• Conductor cross-section, max.	2.5 mm <sup>2</sup>
• Fuse protection, max.	20 A
<b>Power loss, max.</b>	10 W
<b>Encoders which can be evaluated</b>	<ul style="list-style-type: none"> <li>• Incremental encoder sin/cos 1 V<sub>pp</sub></li> <li>• Absolute encoder EnDat 2.1</li> <li>• SSI encoder with incremental signals sin/cos 1 V<sub>pp</sub> (firmware version 2.4 and later)</li> </ul>
• Encoder supply	5 V DC/0.35 A
• Encoder frequency incremental signals, max.	500 kHz
• Signal subdivision (interpolation), max.	16384 times (14 bits)
• SSI baud rate	100 ... 1000 kBaud
• Cable length to encoder, max.	100 m (328 ft)
<b>PE connection</b>	M4 screw
<b>Dimensions</b>	
• Width	30 mm (1.18 in)
• Height	150 mm (5.91 in)
• Depth	111 mm (4.37 in)
<b>Weight, approx.</b>	0.45 kg (0.99 lb)
<b>Certificate of suitability</b>	cULus

<sup>1)</sup> The Pt1000 sensor is not supported when combined with a Control Unit CU305.

## SINAMICS G220 built-in and wall-mounted units

### Supplementary system components

#### Encoder system connection > SMC30 Sensor Module Cabinet-Mounted

##### Overview

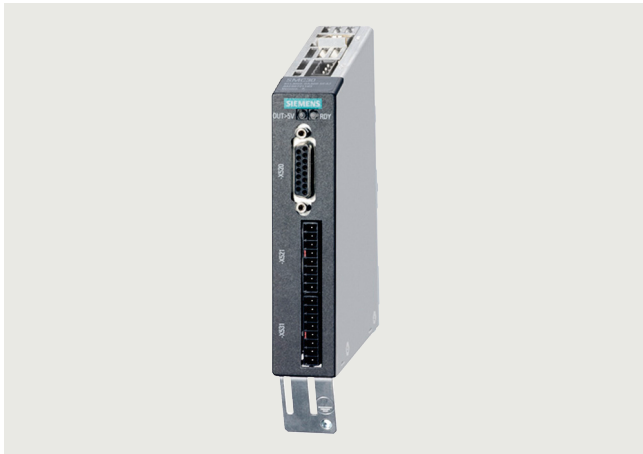

SMC30 Sensor Module Cabinet-Mounted

The SMC30 Sensor Module Cabinet-Mounted is required to evaluate the encoder signals of motors without a DRIVE-CLiQ interface. External encoders can also be connected via the SMC30.

The following encoder signals can be evaluated:

- Incremental encoders TTL/HTL with/without open-circuit detection (open-circuit detection is only available with bipolar signals)
- SSI encoder with TTL/HTL incremental signals
- SSI encoder without incremental signals

The motor temperature can also be sensed using a PTC thermistor KTY84-130, Pt1000<sup>1)</sup> or PTC.

##### Design

The SMC30 Sensor Module Cabinet-Mounted features the following connections and interfaces as standard:

- 1 encoder connection including motor temperature sensing (KTY84-130, Pt1000<sup>1)</sup> or PTC) either via SUB-D connector or via terminals
- 1 DRIVE-CLiQ interface
- 1 connection for the electronics power supply via the 24 V DC supply connector
- 1 PE/protective conductor connection

The status of the SMC30 Sensor Module Cabinet-Mounted is indicated via a multi-color LED.

The SMC30 Sensor Module Cabinet-Mounted can be snapped onto a TH 35 standard mounting rail in according to EN 60715 (IEC 60715).

The maximum encoder cable length between SMC30 modules and encoders is 100 m. For HTL encoders, this length can be increased to 300 m if the A+/A- and B+/B- signals are evaluated and the power supply cable has a minimum cross-section of 0.5 mm<sup>2</sup>.

The signal cable shield can be connected to the SMC30 Sensor Module Cabinet-Mounted via a shield connection terminal, e.g., Phoenix Contact type SK8 or Weidmüller type KLBÜ CO 1. The shield connection terminal must not be used as a strain relief mechanism.

##### Integration

SMC30 Sensor Modules Cabinet-Mounted communicate via DRIVE-CLiQ with selected devices e.g. SINAMICS S110/S120/S150 Control Units and SINAMICS G220 converters with OM-DQ Option Module DRIVE-CLiQ.

##### Selection and ordering data

Description	Article No.
<b>SMC30 Sensor Module Cabinet-Mounted</b>	<b>6SL3055-0AA00-5CA2</b>
Without DRIVE-CLiQ cable	
Accessories for re-ordering	
<b>Dust protection blanking plugs</b> (50 units)	<b>6SL3066-4CA00-0AA0</b>
For DRIVE-CLiQ port	

For the SINAMICS S150 and SINAMICS S120 Cabinet Modules, the SMC30 Sensor Module Cabinet-Mounted can be ordered as an option by specifying order code **K50**.

A second SMC30 can be ordered as an option with the order code **K52** for reliable actual value acquisition when using the Safety Integrated Extended Functions.

##### Technical specifications

	<b>SMC30 Sensor Module Cabinet-Mounted 6SL3055-0AA00-5CA2</b>
<b>Current requirement, max.</b> at 24 V DC, without taking encoder into account	0.2 A
• Conductor cross-section, max.	2.5 mm <sup>2</sup>
• Fuse protection, max.	20 A
<b>Power loss, max.</b>	10 W
<b>Encoders which can be evaluated</b>	<ul style="list-style-type: none"> <li>• Incremental encoder TTL/HTL</li> <li>• SSI encoder with TTL/HTL incremental signals</li> <li>• SSI encoder without incremental signals</li> </ul>
• Input current range TTL/HTL	4 ... 20 mA (typ. 10 mA)
• Encoder supply	24 V DC/0.35 A or 5 V DC/0.35 A
• Encoder frequency, max.	500 kHz
• SSI baud rate	100 ... 1000 kBaud
• Resolution absolute position SSI	30 bits
• Cable length, max.	
- TTL encoder	100 m (328 ft) (only bipolar signals permitted <sup>2)</sup> )
- HTL encoder	100 m (328 ft) for unipolar signals 300 m (984 ft) for bipolar signals <sup>2)</sup>
- SSI encoder	100 m (328 ft)
<b>PE connection</b>	M4 screw
<b>Dimensions</b>	
• Width	30 mm (1.18 in)
• Height	150 mm (5.91 in)
• Depth	111 mm (4.37 in)
<b>Weight, approx.</b>	0.45 kg (0.99 lb)
<b>Certificate of suitability</b>	cULus

<sup>1)</sup> The Pt1000 sensor is not supported when combined with a Control Unit CU305.

<sup>2)</sup> Signal cables twisted in pairs and shielded.

## Engineering tools

**Cybersecurity information**

Siemens provides products and solutions with industrial cybersecurity functions that support the secure operation of plants, systems, machines and networks.

In order to protect plants, systems, machines and networks against cyber threats, it is necessary to implement – and continuously maintain – a holistic, state-of-the-art industrial cybersecurity concept. Siemens' products and solutions constitute one element of such a concept.

Customers are responsible for preventing unauthorized access to their plants, systems, machines and networks. Such systems, machines and components should only be connected to an enterprise network or the internet if and to the extent such a connection is necessary and only when appropriate security measures (e.g. firewalls and/or network segmentation) are in place.

For additional information on industrial cybersecurity measures that may be implemented, please visit

[www.siemens.com/cybersecurity-industry](http://www.siemens.com/cybersecurity-industry)

Siemens' products and solutions undergo continuous development to make them more secure. Siemens strongly recommends that product updates are applied as soon as they are available and that the latest product versions are used. Use of product versions that are no longer supported, and failure to apply the latest updates may increase customer's exposure to cyber threats.

To stay informed about product updates, subscribe to the Siemens Industrial Security RSS Feed under

[www.siemens.com/cert](http://www.siemens.com/cert)

3/2	<b>DriveSim Designer</b>
3/4	<b>DriveSim Engineer</b>
3/6	<b>Siemens Product Configurator</b>
3/7	<b>TIA Selection Tool</b>
3/8	<b>SINAMICS Selector app</b>
3/9	<b>SINAMICS web server for SINAMICS G220</b>
3/13	<b>SINAMICS Startdrive commissioning tool</b>
3/15	<b>SINAMICS DCC (Drive Control Chart) in the TIA Portal</b>



## Engineering tools

### DriveSim Designer

#### Overview

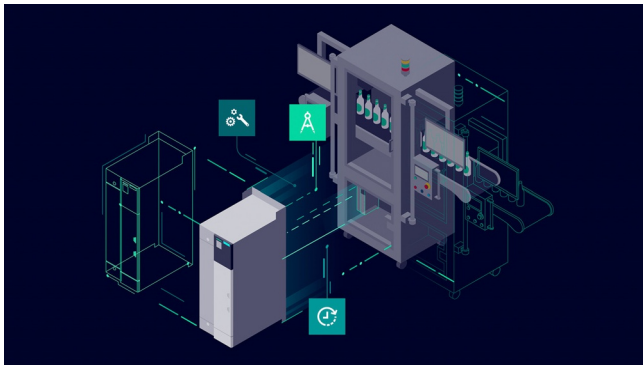

DriveSim Designer provides easy-to-use models for PROFIdrive-enabled SINAMICS converters, so you can create a digital twin of your drive.

The models are validated and tested against real SINAMICS converters and are available in the form of a standardized FMU (Functional Mockup Unit). Therefore, they are compatible with various standard time-based simulation programs such as SIMIT, Simcenter Amesim, ANSYS Twin Builder, MATLAB Simulink or Hopsan.

DriveSim Designer is another element in your engineering toolbox. Together with other virtual Siemens solutions, e.g. SIMATIC S7-PLCSIM Advanced or NX Mechatronics Concept Designer, a consistent model-based development process can be implemented.

#### Benefits

- Speed up time-to-market for OEMs
- Test validated SINAMICS models under real conditions already at the design or planning stage and make needed adjustments
- Identify issues and improvement capabilities early in the design stage and reduce testing effort to save time and cost
- Download the free-of-charge test version for 1 month to try the suitability of our solution before buying it
- DriveSim Designer offers a wide range of additional functionalities to improve the SINAMICS simulation model, e. g. safety or position telegrams
- Valid for the most used Siemens drives

#### Advantages of DriveSim Designer compared to SIMIT PROFIdrive blocks:

- Increased level of detail due to speed controller, current setpoint filters and internal load model
- Identical parameter values and meaning as in the real SINAMICS device
- Direct reference to SINAMICS documentation
- Basic Safety functions
- Brake control functions for lifting applications
- Validated against the real SINAMICS drive
- No wiring effort to represent functional configurations
- Significant reduction of SIMIT simulation tags (even more is possible if unused in-/ outputs are deselected within the Component Type Editor (CTE))
- Enables simulation of an (internal) two-mass oscillator as application with realistic SINAMICS parameter settings, besides the known limitations by the minimum sample time in SIMIT
- Compatible with every FMU Co-Simulation 2.0 compatible simulation tool

#### Application

With DriveSim Designer, you can implement three major use cases:

- Providing load characteristics for drive selection and dimensioning
- Virtual commission your PLC already in the design phase
- Test and improve interaction between PLC, drives and application virtually

#### Use case 1: Dimension and size the correct drive and motor for your application

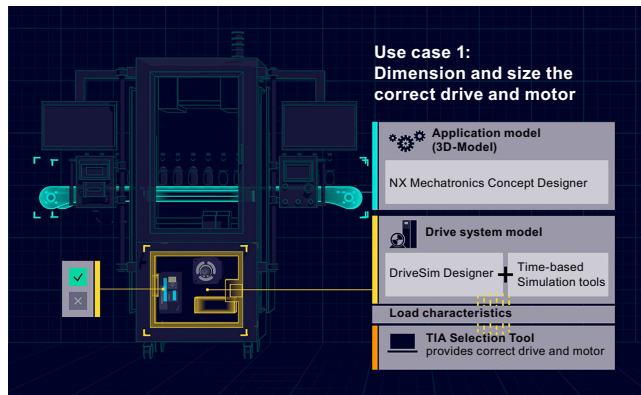

If you are designing a machine, you want to make sure that you select the SINAMICS converter and SIMOTICS motor most suitable for your drive application. As DriveSim Designer is control-unit-agnostic and thus represents a generic drive, you can parametrize it according to the functionality of your application. Running the simulation results in load characteristics, i.e. torque or speed curves over time. You can import these load profiles into TIA Selection Tool to select the suitable Control Unit and dimension the drive to best fit to the demand. So as a result, you have well selected SINAMICS converters and SIMOTICS motors with the help of the digital twin.

#### Use case 2: Virtual commission your drive and PLC early in the design phase

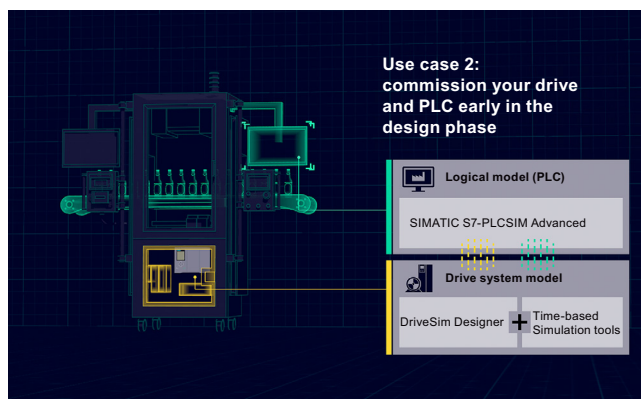

If you are designing a machine, you want to make sure the PLC code works with your SINAMICS drive. After writing the PLC code in TIA Portal, you can connect it via SIMATIC S7-PLCSIM Advanced to any time-based simulation tool (e.g. SIMIT). Integrated into the simulation tool, DriveSim Designer acts as a realistic communication partner for the PLC. Next, you can commission the virtual PLC in TIA Portal as you would do with a real PLC connected to a real drive. Without simulation, you would need to do that on-site. With simulation, you not only save time, but also have the freedom to try out various configurations and optimize your PLC code early in the process.



## Application

Use case 3: Combine the application model and automation model with realistic drive system behavior

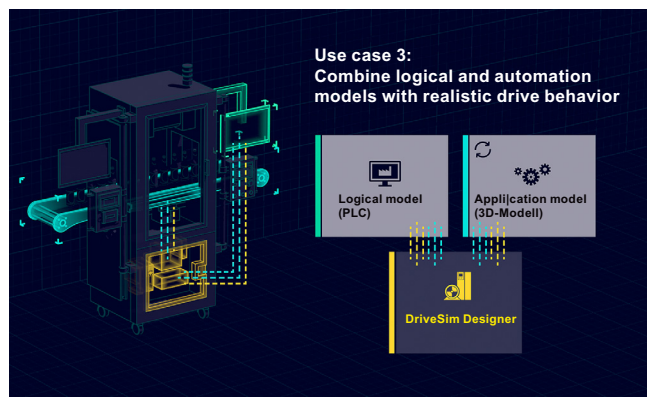

With the third Use case, you can connect a simulation tool such as NX Mechatronic Concept Designer to visualize the mechanical movements of your application. This way, you ensure that the drive behaves according to the desired machine performance. You can test several fault scenarios and optimize the interaction between PLC, application and drive virtually so overall, you can avoid unplanned machine behavior and increase the performance of your setup.

## Integration

DriveSim Designer can be run in tools that support FMU 2.0 Co-Simulation Import (<https://fmi-standard.org/tools/>).

The FMU has been tested in the following simulation environments and is available in the attached application examples.

Tool	Manufacturer	DriveSim*** variant	SIMATIC S7-PLCSIM Advanced interface	Notes
SIMIT	Siemens	***.fmu	Yes	<ul style="list-style-type: none"> <li>Permissible configuration: ExternalLoad = 1 &amp; . Speed-Controller = 0 or ExternalLoad = 0 &amp; . Speed-Controller = 1</li> <li>Simulation with external load can provide wrong results because the minimum possible time step is 1 ms</li> </ul>
Simcenter Amesim	Siemens	***_double.fmu	Yes	
MATLAB Simulink	MathWorks	< 2019a ***_unstruct.fmu ≥ 2019a ***.fmu	Yes	
ANSYS Twin Builder	ANSYS	***.fmu	No	
Hopsan	Linköping University	***_double.fmu	No	<ul style="list-style-type: none"> <li>Open Source</li> <li>Install "win64-with_compiler-installer.exe" package</li> </ul>

## Selection and ordering data

Description	Article No.
DriveSim Designer	9SV1110-3AA00-0AA0

## More information

More information is provided on the internet at:  
[www.siemens.com/drive-virtualization](http://www.siemens.com/drive-virtualization)  
<https://support.industry.siemens.com/cs/document/109812859>

You can find more videos on the topic at:

- Simulation of drive systems - Quick, Easy and Validated
- Simulation of drive systems - An introduction to SINAMICS
- Getting started with DriveSim Designer
- How to import DriveSim Designer into SIMIT, Matlab Simulink, Amesim and ANSYS TwinBuilder
- How to connect DriveSim Designer via SIMATIC S7-PLCSIM Advanced to TIA Portal
- How to use DriveSim Designer for drive sizing with TIA Selection Tool
- How to visualize drive system behavior in NX Mechatronics Concept Designer

## Engineering tools

### DriveSim Engineer

#### Overview

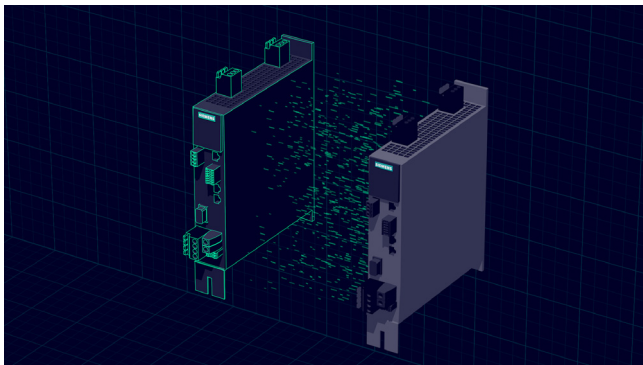

In summary, DriveSim Engineer is a powerful tool that provides a complete digital twin of the next generation of SINAMICS converters SINAMICS G220 and SINAMICS S210 (6SL5...), ensuring unparalleled accuracy and reliability. With its seamless integration into the TIA Portal and SINAMICS Startdrive, the advanced level of customization, the detailed and intuitive interface, it is the ultimate solution for optimizing your drive train system.

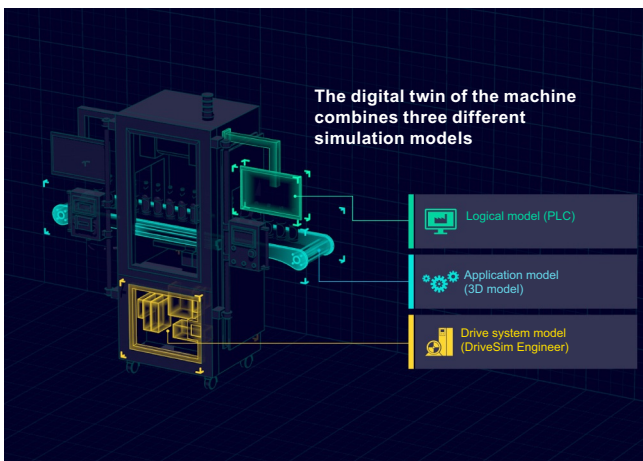

DriveSim Engineer is an innovative solution that combines drive simulation and virtual commissioning. With this powerful combination, you can optimize your drive systems, test and validate your projects and ensure that your drive systems function correctly prior to the installation.

DriveSim Engineer is the ultimate solution for optimizing your drive systems. With its advanced technology and user-friendly interface, you can simulate and optimize the performance of your drive systems to meet the demands of your processes. DriveSim Engineer is the solution you have been searching for to improve efficiency, productivity, as well as the overall performance of your drive systems.

The complete digital twin of the real SINAMICS firmware for the next generation of SINAMICS converters SINAMICS G220 and SINAMICS S210 (6SL5...) ensures that all parameters and configurations are identical to those of the real drive, providing unparalleled accuracy and reliability.

DriveSim Engineer is a software-dependent solution that works seamlessly with the TIA Portal and SINAMICS Startdrive, eliminating the need for additional simulation tools. Its low-level interaction with the current control loop of the real drive ensures that the behavior is validated and verified, making it a reliable partner for optimizing your drive train system.

What sets DriveSim Engineer apart is its advanced level of customization and detail, allowing for more accurate testing and optimization of the drive train system. Its intuitive interface enables the fast set-up and configuration of your digital twin as well as the simulation of different operating conditions and scenarios.

Whether you are designing, commissioning or optimizing your drive train system, DriveSim Engineer is the tool you need. Its advanced features and high level of accuracy make it an essential tool for the best possible system performance.

#### Benefits

- Reduce costs and time: Eliminate the need for on-site visits, reduce costs and speed up the commissioning process.
- Connectivity to SIMATIC S7-PLCSIM Advanced for SINAMICS S210 (6SL5...) with telegram 105
- Testing and optimization of the drive train system without material damage.
- Improved accuracy: Perform precision simulations and tests on your systems, ensuring that they are optimized before the actual purchase.
- Increased flexibility: Make changes to your systems quickly and easily with flexibility to respond to the changes in your project requirements.
- Train the engineers and new users with the help of the virtual twin acting as a realistic partner.
- Virtual demonstration of the SINAMICS converters (prior to mounting or purchase).
- Diagnose and validate the faults or issues in the real environment and fix them with the help of the simulation without any risk of material damage and save resources (lower maintenance and downtime time, i.e. lower costs) without time pressure on the plant side.
- Identify issues and improvement capabilities early in the design stage and reduce testing effort to save time and cost.
- Valid for the next generation of SINAMICS converters SINAMICS G220 and SINAMICS S210 (6SL5...).

## Application

DriveSim Engineer can be implemented in three major use cases.

Use case	Old approach	Advantages of the new approach with DriveSim Engineer
Virtual commissioning and engineering of the next generation of SINAMICS converters SINAMICS G220 and SINAMICS S210 (6SL5...) prior to the mounting	Commissioning of the converters after mounting or purchase	<ul style="list-style-type: none"> <li>• Saving of resources (lower maintenance and shorter downtime, i.e. lower costs)</li> <li>• No time pressure in the real installation, quick and fast reconfiguration of the system</li> <li>• Improved accuracy of the drive train system in detecting and resolving potential issues</li> <li>• Virtual commissioning helps ensure that the system is future-proof by incorporating the latest technologies and design standards.</li> </ul>
Virtual training and demonstration of the next generation of SINAMICS converters SINAMICS G220 and SINAMICS S210 (6SL5...) for engineers and new users	Trainings and demonstrations on the plant side (not in advance)	<ul style="list-style-type: none"> <li>• Virtual trainings and demonstrations in advance with the digital twin acting as a realistic partner</li> <li>• Make the changes to your systems quickly and easily.</li> <li>• Show and use different application (drives) just on one computer (no need for demo cases).</li> <li>• Traveling costs for trainings and demonstrations will not rise. Everything can be done virtually and in advance (before the hardware is purchased or released).</li> </ul>
Diagnose and validate the faults or issues in the real environment and fix them with the digital twin (optimization of the real machine)	Faults and issues of the system are solved on the plant side	<ul style="list-style-type: none"> <li>• Saving of resources (lower maintenance and shorter downtime, i.e. lower costs)</li> <li>• No time pressure in the real installation, quick and fast reconfiguration of the system</li> <li>• Improved accuracy of the drive train system in detecting and resolving potential issues</li> <li>• Virtual commissioning helps ensure that the system is future-proof by incorporating the latest technologies and design standards.</li> </ul>

## Integration

DriveSim Engineer is directly integrated in TIA Portal and SINAMICS Startdrive, i.e. different software tools are not necessary. Only the installation of DriveSim Engineer, TIA Portal with SINAMICS Startdrive and SIMATIC S7-PLCSIM Advanced is required.

## Selection and ordering data

Description	Article No.
<b>DriveSim Engineer V1.1 – Perpetual license (unlimited)</b>	<b>9SV1210-4AA00-0AA0</b>
<b>DriveSim Engineer V1.1 – Subscription (1 year license)</b>	<b>9SV1210-3AA00-0AA0</b>
<b>DriveSim Engineer V2.0 – Perpetual license (unlimited)</b>	<b>9SV1310-4AA00-0AA0</b>
<b>DriveSim Engineer V2.0 – Subscription (1 year license)</b>	<b>9SV1320-3AA00-0AA0</b>

## More information

More information is provided on the internet at:  
[www.siemens.com/drive-virtualization](http://www.siemens.com/drive-virtualization)

## Engineering tools

### Siemens Product Configurator

#### Overview

The Siemens Product Configurator helps you to configure the optimum drive technology products for a number of applications. The product portfolio comprises the full drive technology range of gearbox, motor, converter and connection system as well as corresponding controller with suitable software license. The intuitive user interface in conjunction with product-specific preliminary selectors makes it simple, fast and efficient to configure products. The result is a bill of materials with extensive documentation consisting of technical data sheets, motor characteristic curves, 2D dimensional drawings / 3D CAD models, EPLAN macros and much more. You can order the products directly by transferring the bill of materials to the shopping cart of SiePortal.



#### **Siemens Product Configurator at a glance**

- Quick and easy configuration of drive products and associated components – gearboxes, motors, converters, controllers, connection systems
- Extensive documentation for all products and components, such as
  - Data sheets in up to 12 languages
  - Motor characteristic curves
  - 2D dimensional drawings / 3D CAD models in different formats
  - Terminal box drawing and terminal connection diagram
  - Certificates
  - EPLAN macros
- Ability to order products directly through SiePortal

#### Access to the Siemens Product Configurator

The Siemens Product Configurator can be accessed without the need for registration or logging in:  
[www.siemens.com/spc](http://www.siemens.com/spc)

## Overview

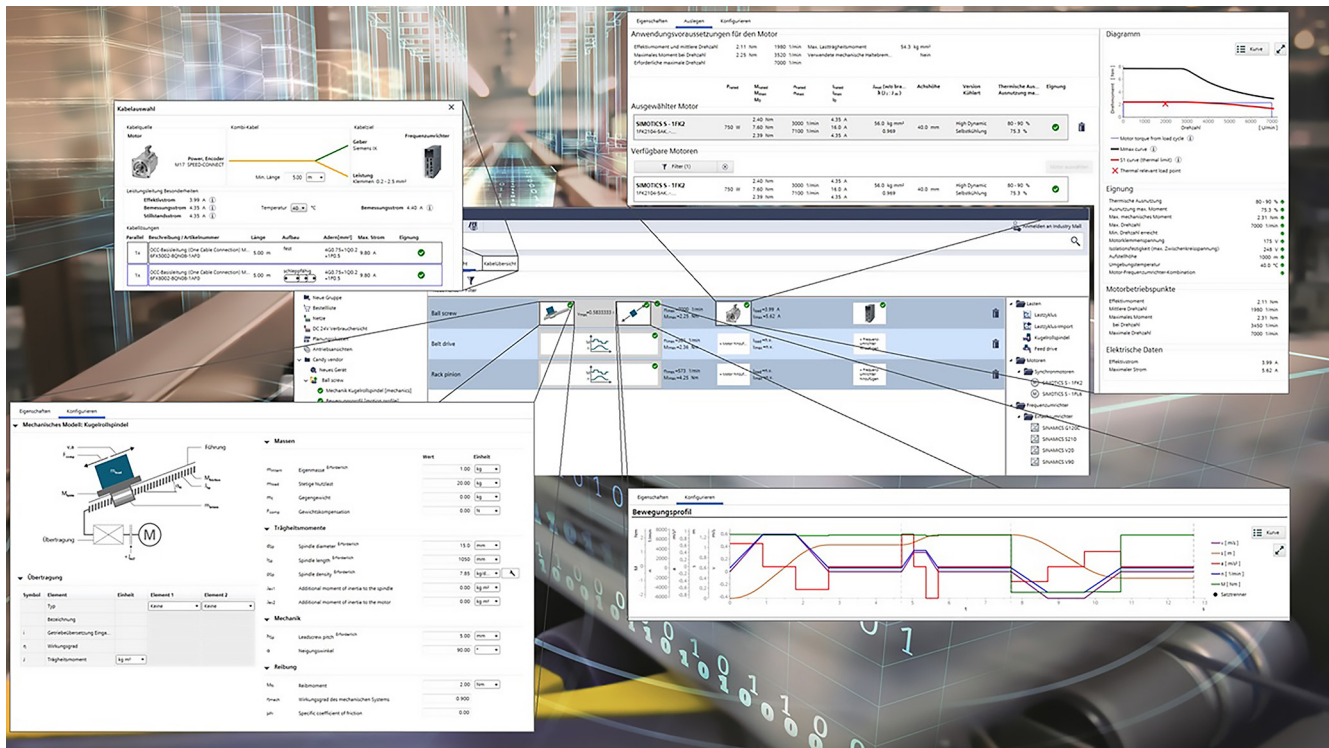
Selection guide and configurator for automation technology

Error-free configuration without expert knowledge through intelligent configurators and selection wizards. Desktop and cloud versions enable cross-team collaboration with maximum flexibility.

There are two versions of the TIA Selection Tool:

- for downloading and executing on Windows PCs (from Microsoft Windows 10)
- One for running from the cloud, which is launched from mobile devices directly in the browser (we recommend Safari, Chrome and Firefox)

Projects stored in the cloud can be edited with both tools. This makes it possible to work on-the-go using a tablet, at home on a PC – and vice versa, or together with colleagues and customers.

In order to use the full functionality, we recommend setting up a SiePortal account for both cases. This gives you access to prices and enables you to save your projects to our cloud.

You can find additional information about the TIA Selection Tool at:

[www.siemens.com/tia-selection-tool](http://www.siemens.com/tia-selection-tool)

Drive dimensioning in the TIA Selection Tool

Application-specific requirements can be determined using drive technology dimensioning in the TIA Selection Tool. This can include motors, gearboxes and converters. The tool supports the configuration and dimensioning of control functions with an open and closed control loop. The technical documentation with features of the technical drive system, as well as a product list for ordering via SiePortal can also be compiled.

You can find more information on the SIZER for Siemens Drives engineering tool at

<https://support.industry.siemens.com/cs/ww/en/ps/13434/dl>



## Engineering tools

### SINAMICS Selector app

#### Overview

##### ***SINAMICS Selector app: Your guide to frequency converters***

Finding the right frequency converter for your application can be a challenge. But SINAMICS Selector app makes your selection process quick and easy – reducing it to just a few clicks.

As an app, the digital guide is accessible even on the go. It helps you navigate the comprehensive range of SINAMICS converters and guides you reliably to the one that matches your application.

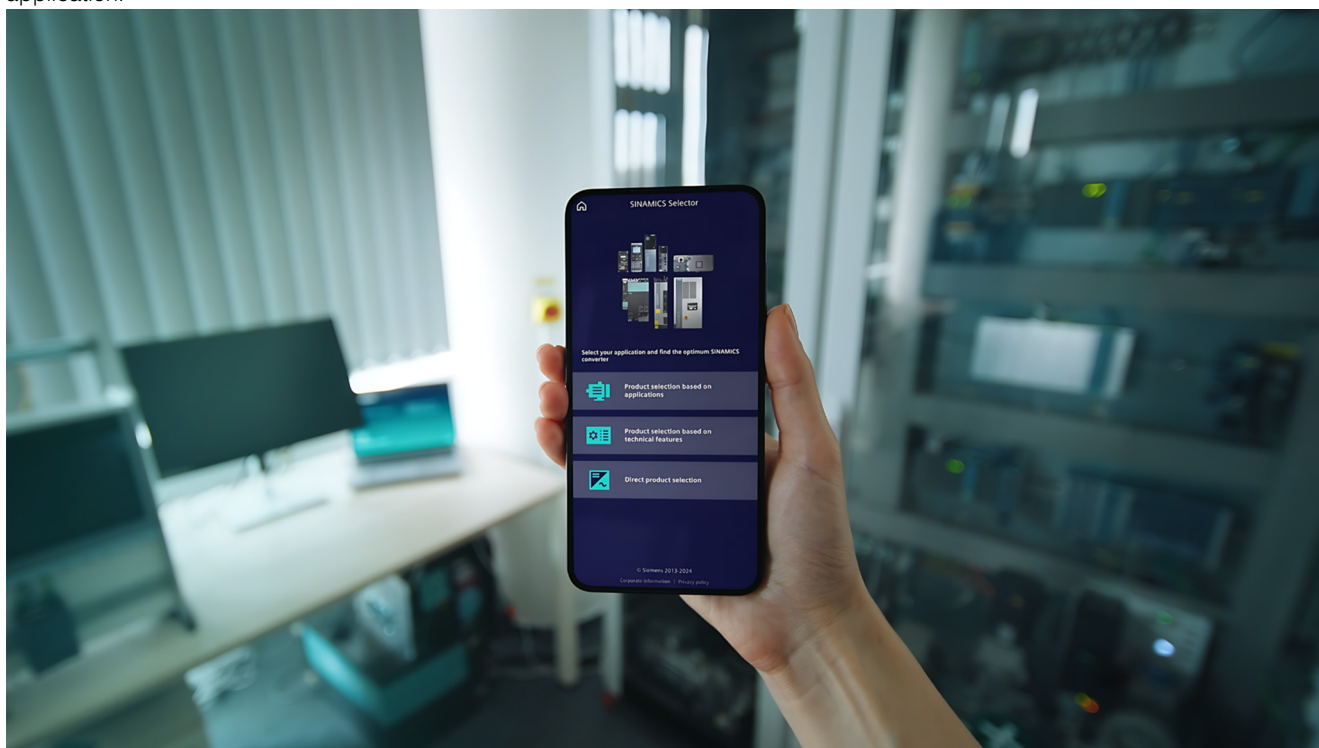

##### ***Drive selection on the go: benefits at a glance***

SINAMICS Selector app is designed to help you find the right frequency converter easily and quickly. To ensure that the app is accessible to everyone, we prioritized a clear structure and functional design. In addition, the selection process consists of only five steps. In this way, SINAMICS Selector app offers a smart, swift and smooth path to select and purchase your converter.

You will find free downloads for Android and iOS here:  
[www.siemens.com/sinamics-selector](http://www.siemens.com/sinamics-selector)

## Overview

### Web server for efficient commissioning, diagnostics, maintenance and operator control and monitoring, any time, from anywhere

Thanks to the web server, the SINAMICS G220 drive system offers an efficient commissioning, diagnostics, maintenance option as well as operation and monitoring functions. The user is supported by a help function and additional links to specific product information, downloads, FAQs and manuals. The web server provides access to a multi-faceted range of new options for commissioning or parameter assignment, drive diagnostics, remote maintenance as well as operator control and monitoring for any networked PC with a web browser or for tablets and smartphones (via a separate WLAN access point, such as SINAMICS Smart Adapter). The following provides an insight into the functionality offered.

The start screen offers a quick overview of the state of the drive

- Drive type, connected motor as well as the article number and installed firmware
- Important drive parameters show the operating state (can be configured)
- The connection overview provides information about the status of the connections (operating unit - converter - motor)
- Overview of all pending fault and warning messages

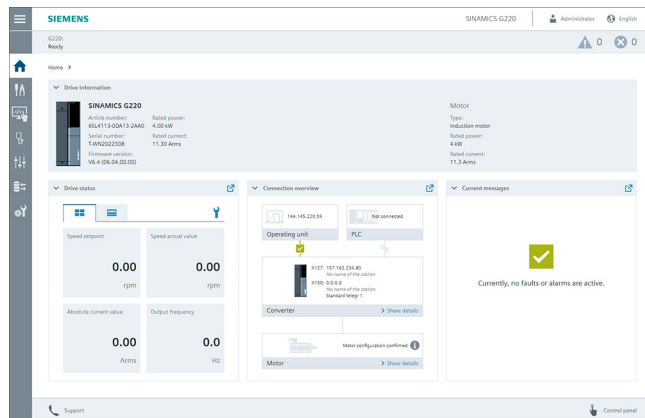

Start screen of the web server integrated into SINAMICS G220

### Commissioning

- In the quick commissioning, the most important drive characteristics are defined, e.g. motor data, limit values and the configuration of the inputs and outputs. If a motor-side filter is installed, the advanced commissioning has to be used.
- In the advanced commissioning, drive options and functions are defined to suit your application. The advanced commissioning includes all the settings of the quick commissioning as well as additional options and functions.
- Safety Integrated commissioning guides you through the commissioning of the Safety Integrated functions of the converter.

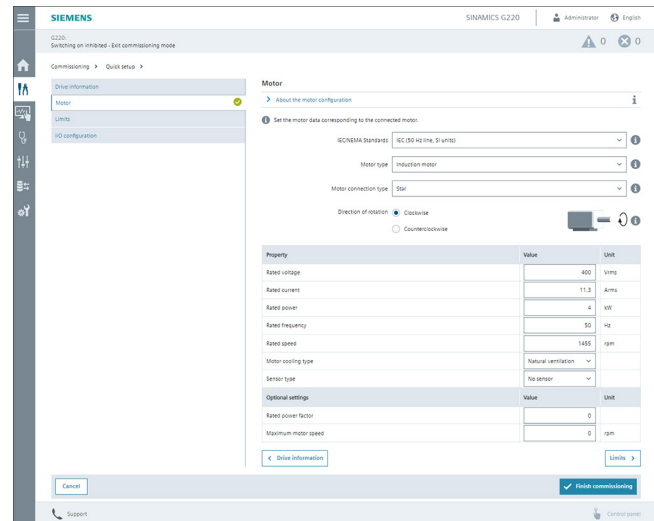

Quick commissioning with open dialog showing the set motor data

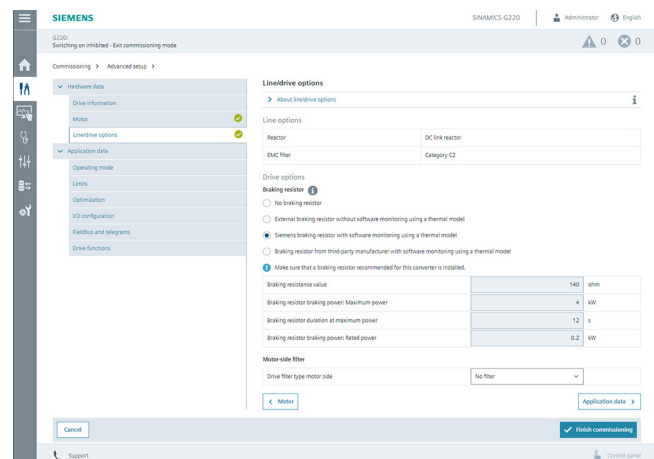

Advanced commissioning with open dialog for the line/drive options

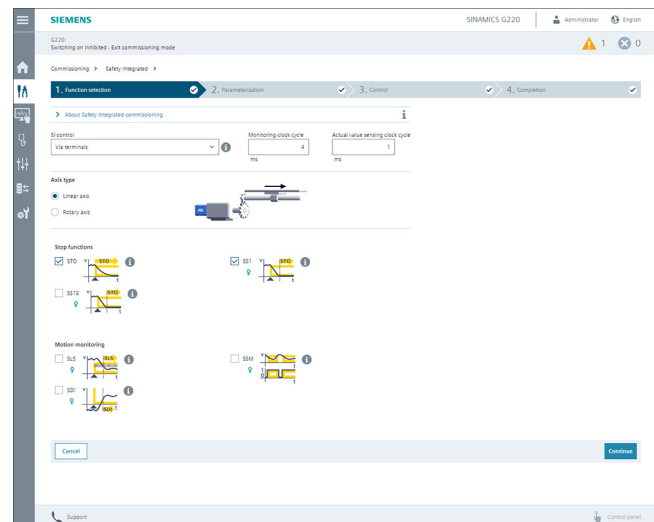

Safety Integrated assistant



# Engineering tools

## SINAMICS web server for SINAMICS G220

### Overview

#### Operator control and monitoring

- Configurable drive status with value or trend display
- Status of the inputs and outputs
- Drive traversing via the control panel, which can be freely positioned on the screen

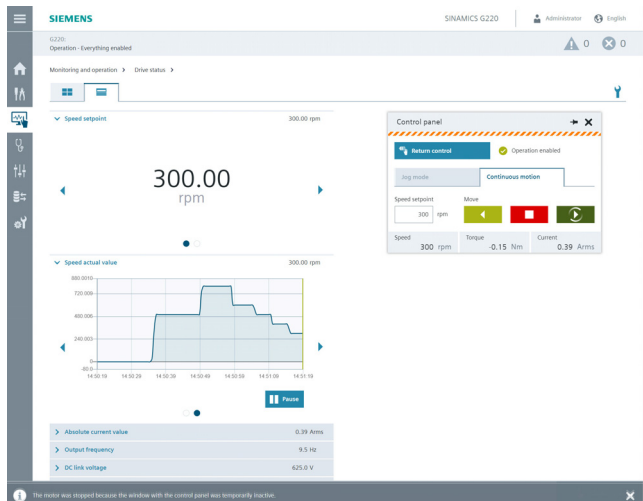

Operator control and monitoring of the drive with the help of the drive status and control panel

#### Diagnostics

- Evaluation of warnings and fault messages
- Evaluation of system events (diagnostic buffer)
- Analysis of the safety status
- Connection overview, diagnostics of the drive communication and control and status words

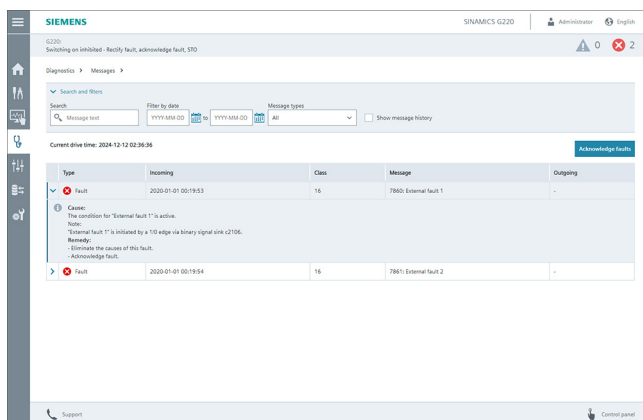

Alarm view with convenient search and filter functions

#### Service and maintenance functions

- Monitor and adjust drive parameters
- Convenient creation and management of signal interconnections
- Create, import and export user-specific parameter lists
- Back up and restore the drive configuration
- Perform firmware update, also via the network
- Manage software licenses
- Configure basic settings for the drive and web server (e.g. date and time of the drive)
- Configure and manage user accounts and access controls (UMAC)

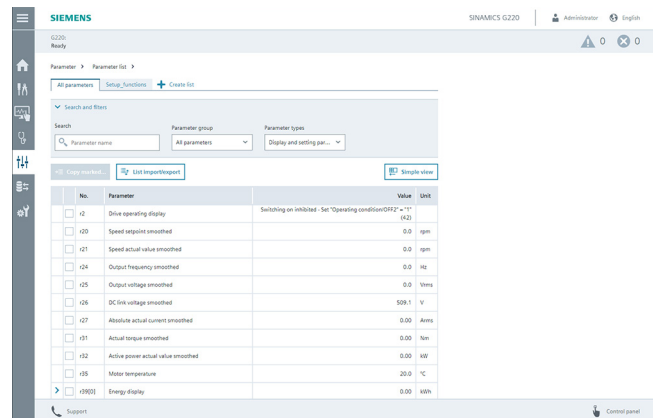

Parameter list for quick access to drive parameters, also via user-defined parameter lists

#### Support

- Operator support with comprehensive information about the drive and user interface
- Easy access to product information such as FAQs, software downloads, manuals and certificates
- When storing the html documentation on the drive memory card, the user manual can be accessed in a context-sensitive manner from the user interface
- The diagnostics report supports the support with basic information on the current status of the converter, e.g. in the event of a malfunction or error. The diagnostics report always contains the drive, motor and encoder data and, optionally, an overview of the errors and messages that have occurred.

## Overview

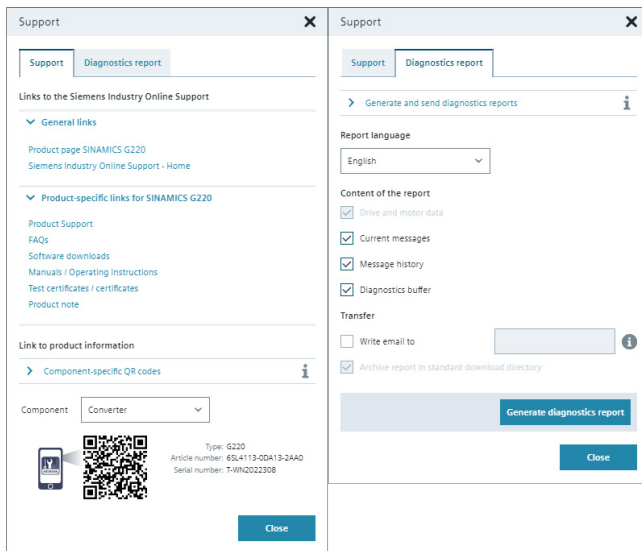

Support dialog for quick access to product-specific information

## Benefits

### Simple and fast commissioning

- Installation of additional commissioning software is not required. Tools required for the commissioning are ready to use via the integrated web server.
- Standard pages to set thresholds and onboard inputs
- Guided parameterization of Safety Integrated functions
- Extensive online help with context-sensitive access to the Operating Instructions (memory card required)

### Shorter machine downtimes

- Quick overview of the current configuration and the state of the drive
- Efficient diagnostics and maintenance
- Understandable diagnostic information and messages, including the causes of issues and possible remedies, are displayed in plain text in multiple languages
- Context-sensitive help with optional access to the web-based device documentation provides quick help with questions about drive functions

### Convenient service and maintenance functions

- Quick backup and restoration of the drive data
- Convenient firmware update, also via the network
- Convenient access to drive parameters and their signal interconnections
- User-defined parameter lists that focus on what matters
- Easy and efficient handling of the parameter list by using search functions and filters (e.g. parameter groups, parameter types)
- Easy exchange with operating personnel by importing/exporting user-defined parameter lists.
- User-defined parameter lists can be exchanged between the SINAMICS Startdrive and the web server.
- The generation and dispatch of a diagnostics report supports communication with service personnel or machine builders.

### Direct language selection

- English, French, German, Italian, Spanish, Chinese Simplified

### Accessibility

- Via all LAN or PROFINET interfaces
- Use of mobile devices (e.g. notebooks/tablets and smartphones) via WLAN e.g. with SINAMICS Smart Adapter or a separate access point
- Access to the web server via PCs/notebooks, SIMATIC HMI (> 10"), smartphones/tablets with a Chromium-based internet browser

### Access security

- Protection against unauthorized access to the drive functions and data
- Convenient user administration that supports a roles concept
- Easy set-up and management of user accounts

## Application

The web server is ideal for applications not requiring any special commissioning software or version dependencies. Commissioning, diagnostics and maintenance as well as operator control and monitoring are possible both locally and remotely, provided appropriate security measures are applied.

# Engineering tools

## SINAMICS web server for SINAMICS G220

### Integration

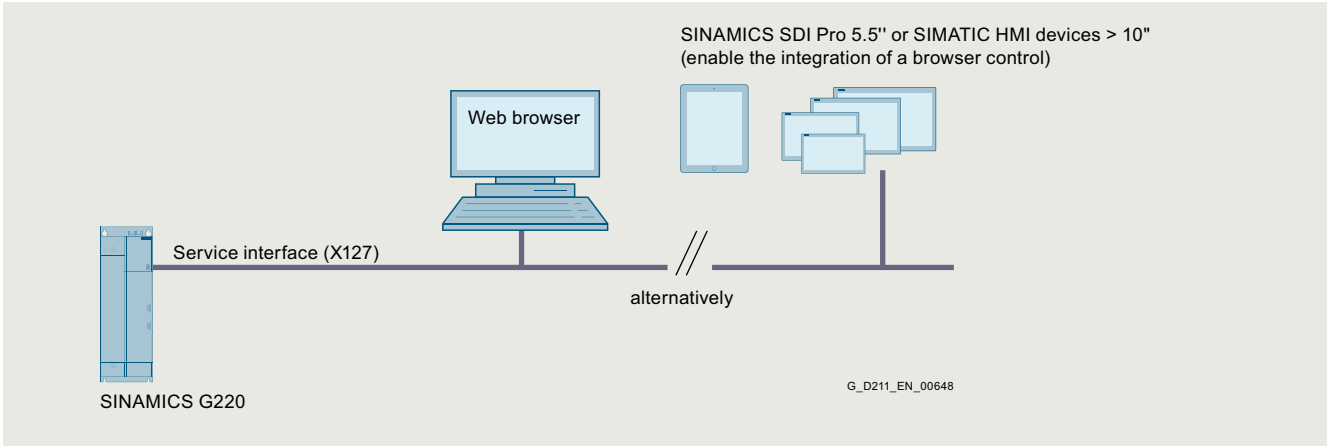

Integration of the SINAMICS web server based on the example of a SINAMICS G220 and the service interface (X127)

3

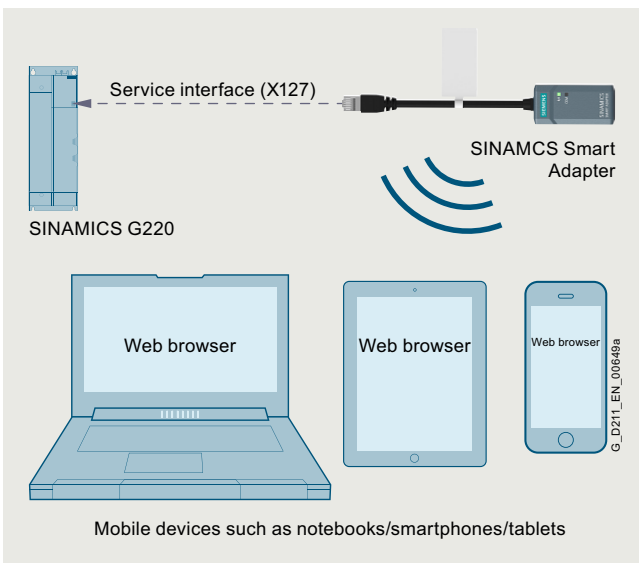

Wireless access to the web server via the service interface (X127) of the SINAMICS G220 with the help of the SINAMICS Smart Adapter

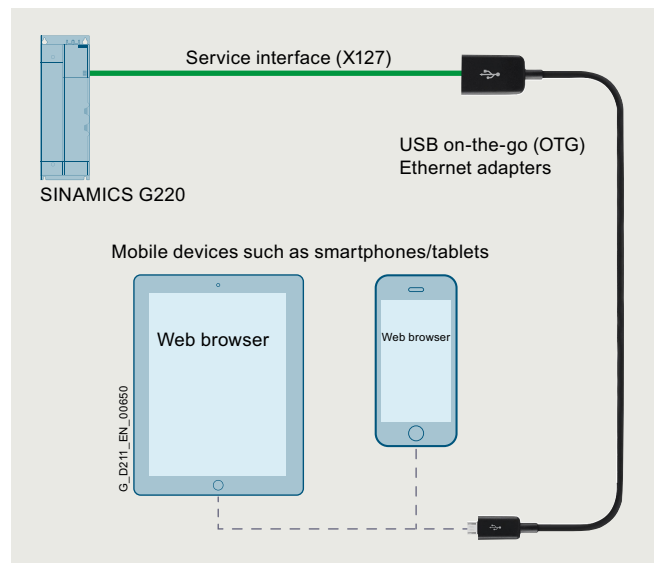

Access to the web server via the service interface (X127) of the SINAMICS G220 with the help of a USB on-the-go (OTG) Ethernet adapter

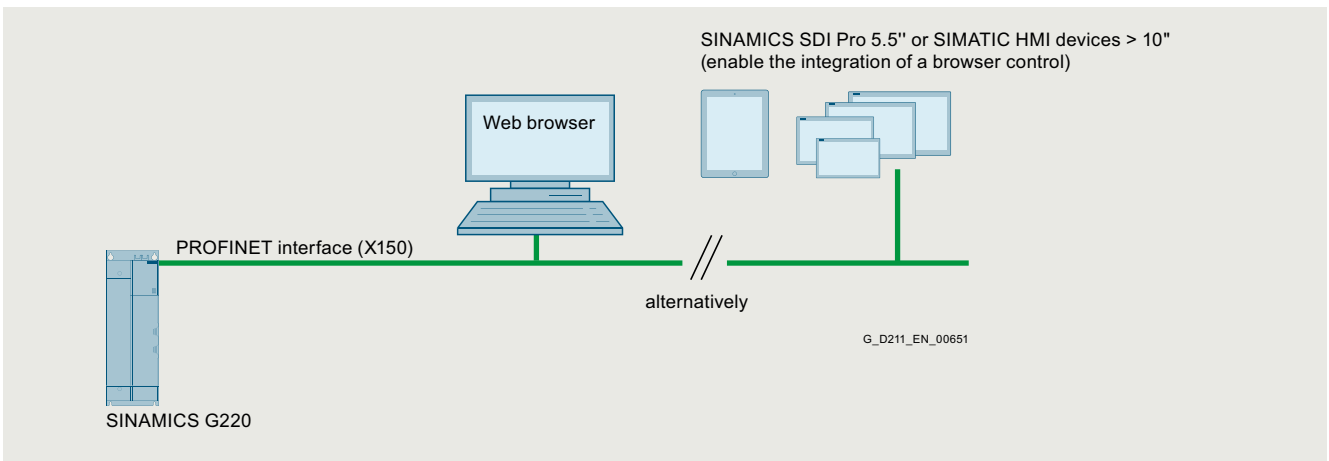

Integration of the SINAMICS web server based on the example of a SINAMICS G220 and the PROFINET interface (X150) as connected web client (e.g. PC, SIMATIC HMI etc.)

## Overview

SINAMICS Startdrive is integrated in the TIA Portal and is a tool for the configuration, commissioning and diagnostics of the SINAMICS family of converters.

The SINAMICS Startdrive commissioning tool has been optimized with regard to user friendliness and consistent use of the TIA Portal benefits of a common working environment for PLC, HMI and drives. Time-saving and guided step-by-step commissioning with maximum flexibility is complemented by user-friendly graphic function views for all drive functions, including functional safety (Safety Integrated) and drive-based technology functions (e.g. EPOS). The automatic message display, the powerful real-time trace and the context-sensitive online help make converter diagnostics very easy.

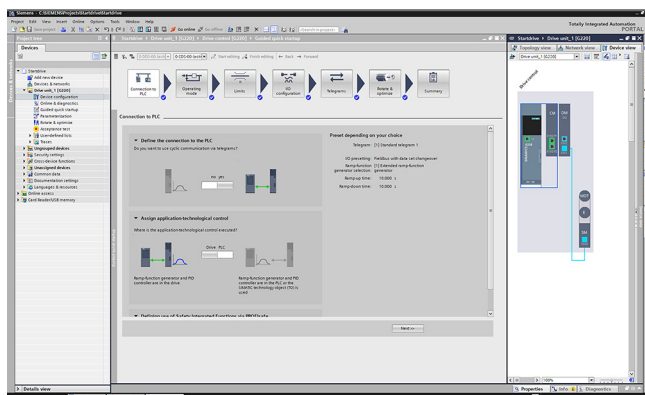

The software packages based on the TIA Portal are harmonized with each other and offer important benefits, the main advantage being a shared project storage. The TIA Portal enables simple integration of SINAMICS converters in your automation solution. Thanks to the standardization of operator actions and the integration in general TIA Portal operating concepts (e.g. UMAC, Openness) as well as standard TIA Portal functions (e.g. Undo/Redo), familiarization is easy both for drive experts as well as SIMATIC users. Special focus is placed on the interaction between SIMATIC and SINAMICS, especially when connecting the SINAMICS drives to SIMATIC technology objects.

## Integration

### Supported frequency converters

SINAMICS Startdrive Basic enables complete commissioning, diagnostics, parameterization, optimization and connection to the PLC for the following SINAMICS converters integrated in SINAMICS Startdrive:

- SINAMICS G120, G120C, G120D, G120P
- SINAMICS G115D
- SINAMICS G130, G150
- SINAMICS G220 (as of V18 SP2 Update 1)
- SINAMICS S120<sup>1)</sup>, S150
- SINAMICS S200 (as of V18 SP2)
- SINAMICS S210 (6SL3...) and innovated SINAMICS S210 (6SL5...) (as of V18 SP1)
- SINAMICS MV

<sup>1)</sup> Includes SINAMICS S220 Smart Line Modules booksize format as of SINAMICS Startdrive V17 Update 1.

## SINAMICS Startdrive Advanced

With SINAMICS Startdrive Advanced (available as of V15) you benefit from powerful engineering functions that save you considerable time and ultimately costs.

- Safety acceptance test:
  - Guided acceptance test wizard for all drive-based Safety Integrated functions
  - Automatic and safety function-specific generation of traces to analyze the machine behavior
  - Generation of an acceptance report as Excel file (xlsx format, can also be used with OpenOffice)
- Improved optimization options in the drive: Extended measuring functions (available for CU320-2 PN/DP and CU310-2 PN as of V5.2 SP3, SINAMICS S210 (6SL5...) as of V6.1 and SINAMICS S200 as of V6.2), long-term trace
- Export of backup files from the Startdrive project
- Also contains all Startdrive Basic functions
- Only license key required, no additional installation

## New in V20

### Startdrive Basic V20

- Comparison of drive parameters between different drives
- Trace templates for easy creation of trace configurations
- Unit Switching (SI/US Units)
- Integration of the drive version V6.4 for SINAMICS G220, S200, S210 (6SL5...):
  - Introduction of OPC UA server functionality for devices from V6.4

### Startdrive Advanced V20

- Export of backup files for drives from V6.x for efficient roll-out of drive parameterizations via SD card

## Installation versions

SINAMICS Startdrive can only be installed as an option package for SIMATIC STEP 7. However, a SIMATIC STEP 7 license is not required to run SINAMICS Startdrive.

## System requirements

The following table shows the recommended hardware and system equipment for the operation of SINAMICS Startdrive.

Hardware	Recommendation
<b>Computer</b>	As of SIMATIC FIELD PG M6 Comfort (or comparable PC)
<b>Processor</b>	Intel Core i5-8400H (2.5 ... 4.2 GHz; 4 cores + hyper-threading; 8 MB Smart Cache)
<b>RAM</b>	16 GB or more (32 GB for large projects)
<b>Hard disk</b>	SSD with at least 50 GB available memory
<b>Screen resolution</b>	15.6" Full HD display (1920 × 1080 or larger)
<b>Operating systems</b>	<ul style="list-style-type: none"> <li>• <b>Microsoft Windows 10 (64 bit)</b> <ul style="list-style-type: none"> <li>- Windows 10 Professional Version 22H2</li> <li>- Windows 10 Enterprise 21H2, 22H2</li> <li>- Windows 10 Enterprise 2019 LTSC</li> <li>- Windows 10 Enterprise 2021 LTSC</li> </ul> </li> <li>• <b>Microsoft Windows 11 (64 bit)</b> <ul style="list-style-type: none"> <li>- Windows 11 Home Version 22H2, 23H2</li> <li>- Windows 11 Professional Version 22H2, 23H2</li> <li>- Windows 11 Enterprise 22H2, 23H2</li> </ul> </li> <li>• <b>Microsoft Windows Server (64 bit)</b> <ul style="list-style-type: none"> <li>- Windows Server 2019 Standard (full installation)</li> <li>- Windows Server 2022 Standard (full installation)</li> </ul> </li> </ul>

## Engineering tools

### SINAMICS Startdrive commissioning tool

#### Integration

##### Compatibility with other products

- SINAMICS Startdrive V20 operates with STEP 7, WinCC and Scout TIA V20 in one framework
- SINAMICS Startdrive V20 can be installed on the same computer in parallel with other versions of SINAMICS Startdrive V12 to V19
- SINAMICS Startdrive can be installed on the same computer as SINAMICS MICROMASTER STARTER

##### Supported virtualization platforms

SINAMICS Startdrive can be installed in a virtual machine. For this purpose, one of the following virtualization platforms in the specified version or a newer version can be used:

- VMware vSphere Hypervisor (ESXi) 8.0 or higher
- VMware Workstation 17.0 or higher
- VMware Player 17.0 or higher
- Microsoft Hyper-V Server 2019 or higher

##### Supported safety programs

The following safety programs have been tested with SINAMICS Startdrive V20:

- Virus scanners:
  - Symantec Endpoint Protection 14.3 RU8
  - Trend Micro Apex One
  - McAfee Endpoint Security (ENS) 10.7
  - Microsoft Defender
  - Qihoo 360 (Safe Guard and Virus Scanner)
  - CrowdStrike Falcon Go (Falcon Prevent and Falcon Device Control)
- Encryption software:
  - Microsoft Bitlocker
- Host-based Intrusion Detection System
  - McAfee Application Control 8.4 (Trellix)

#### Selection and ordering data

Description	Article No.
<b>SINAMICS Startdrive Basic V20 commissioning tool</b> Single license and certificate of license English, French, German, Italian, Spanish, Chinese Simplified • Software download (email address required for delivery)	<b>6SL3072-4LA02-0XG0</b>
<b>SINAMICS Startdrive Advanced V20 commissioning tool</b> License key (floating license) English, French, German, Italian, Spanish, Chinese Simplified • On DVD-ROM with license key on USB flash drive • Software download incl. license key (email address required for delivery)	<b>6SL3072-4LA02-0XA5</b> <b>6SL3072-4LA02-0XG5</b>
<b>Upgrade SINAMICS Startdrive Advanced V15 ... V19 to V20</b> • On DVD-ROM with license key on USB flash drive • Software download incl. license key (email address required for delivery)	<b>6SL3072-4LA02-0XE5</b> <b>6SL3072-4LA02-0XK5</b>
<b>Software Update Service with SINAMICS Startdrive Advanced in the TIA Portal</b> Delivery is performed according to the number of ordered SUS products (e.g. 10 upgrade license keys (floating license) with 10 DVD-ROMs, 10 USB flash drives, etc.) • On DVD-ROM with upgrade license key on USB flash drive • Software download incl. license key (email address required for delivery)	<b>6SL3072-4AA02-0XL8</b> <b>6SL3072-4AA02-0XY8</b>

##### Note:

SINAMICS DCC can be installed in addition to the SINAMICS Startdrive commissioning tool. This allows the device functionality in the SINAMICS drive system to be expanded with dedicated technological functions as required.

Further information about SINAMICS DCC can be found in the section SINAMICS DCC (Drive Control Chart) in the TIA Portal.

##### Accessories

Depending on the version of the Control Unit (CU), the Control Unit of the drive unit can communicate with the programming device (PG) or PC via PROFIBUS or PROFINET/Ethernet or via a serial interface. The following accessories are available for the particular drive system as listed in the following table.

Recommended accessories For communication between the drive unit and the programming device or PC	
Description	Article No.
<b>SINAMICS G220</b> • Wi-Fi <b>SINAMICS Smart Adapter</b> Wi-Fi solution for the next generation of SINAMICS converters SINAMICS S200, SINAMICS S210 (6SL5...) and SINAMICS G220	<b>6SL4950-0AJ00-0AA0</b>

#### More information

The SINAMICS Startdrive Basic commissioning tool is available free on the internet at [www.siemens.com/startdrive](http://www.siemens.com/startdrive)

## Overview

SINAMICS DCC (Drive Control Chart) is a technological expansion for the SINAMICS drive systems. This allows the device functions of the converter systems to be expanded individually and flexibly with freely available closed-loop control, arithmetic and logic blocks and thus opens up a new dimension of adaptation capabilities for the specific functions of the machine for the user. The user-friendly configuration tool in the TIA Portal enables simple, graphic configuration of these blocks and integrates them in the drive unit. SINAMICS DCC is available as an option for SINAMICS Startdrive Basic and Advanced in the TIA Portal.

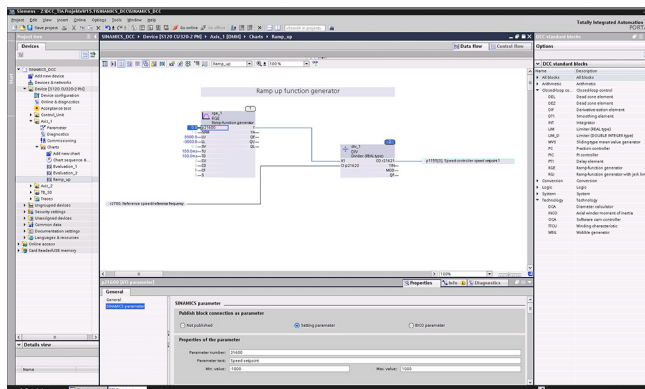

With the integration into the TIA Portal, the focus is on simple usability. For this reason, closed loop control and open loop control functions can be graphically interconnected in just a few steps via drag and drop.

The SINAMICS DCC installation contains a comprehensive standard block library. Furthermore, additional libraries can be installed as DCB Extension to expand the range of functions of the blocks. The diagnostics functions allow the program behavior to be verified and, in the case of a fault, the cause to be identified.

Via the Siemens application support, a range of example applications (winder, synchronous operation, cross-cutter, etc.) are available for download on the basis of SINAMICS DCC and can be used as a ready-to-use solution or be individually adapted or expanded.

### Supported frequency converters

With SINAMICS DCC, you can flexibly and individually extend the following devices:

- SINAMICS G220 (as of drive version V6.4)
- SINAMICS G130, G150
- SINAMICS S120, S150
- SINAMICS MV
- SINAMICS S120 integrated in SIMATIC Drive Controller

### New in V20

- Support of SINAMICS DCC with SINAMICS G220 from drive version V6.4
- Support of indexed parameters in SINAMICS G220
- Extension of user-specific SINAMICS DCC messages with SINAMICS G220
- New device types for SINAMICS DCC with SINAMICS G220 available

### Licenses

With the support of SINAMICS DCC for SINAMICS G220 drive units, licensing becomes even easier and more flexible. While the SINAMICS DCC Combo engineering licenses are still required for the drive units with drive version V5.x (e.g. SINAMICS S120), SINAMICS DCC Engineering licenses are no longer required for the SINAMICS G220 drive units. Instead, the licensing depends on the scope of the SINAMICS DCC application.

For simple SINAMICS DCC applications with up to 20 modules, the SINAMICS DCC application can even be used free of charge! For more extensive SINAMICS DCC applications, scalable SINAMICS Drive licenses are available, which are precisely tailored to the required needs.

In order to be able to project SINAMICS DCC with the V6.x drive version, the SINAMICS DCC V20 Basic product variant is required.

In the case of using SINAMICS DCC with the V5.x drive version, the SINAMICS DCC V20 Combo Floating License is required, which is offered in the product of the same name. The floating license allows the use of software on any number of computers. This allows one user per license to use the software independently of the computer being used or a specific workstation. The number of existing licenses determines the number of computers on which the software can be used simultaneously.

- Existing SINAMICS DCC combo licenses V15 ... V19 can be upgraded to V20. This requires an upgrade license.
- The combo license allows parallel use of SINAMICS DCC V3.3/V3.4/V3.5/V3.6 and SINAMICS DCC V20 if both tools are installed on the same PC.

### Installation versions

SINAMICS DCC is an option package for SINAMICS Startdrive Basic and Advanced.

### System requirements

The SINAMICS DCC V20 option package has the same system requirements and supports the same virtualization platforms and safety programs as SINAMICS Startdrive V20.

### Compatibility with other products

- SINAMICS DCC V20 operates with Startdrive, STEP 7 and WinCC in one framework
- SINAMICS DCC V20 can be installed on a computer in parallel with SINAMICS MICROMASTER STARTER with SINAMICS DCC

### Supported languages

- Standard installation: English, German, Chinese (simplified)
- Language packages: French, Italian, Spanish



## Engineering tools

### SINAMICS DCC (Drive Control Chart) in the TIA Portal

#### Selection and ordering data

SINAMICS DCC in the TIA Portal, consisting of the graphical configuration tool and the standard library, is the continuation of SINAMICS DCC in the STARTER.

For drive versions V5.x. no runtime license is required for the standard library included in the scope of supply.

Description	Article No.
<b>SINAMICS DCC V20 Basic</b> Single License as an option package for SINAMICS Startdrive Basic or Advanced V20 for SINAMICS drives as of drive version V6.4 German, English, French, Italian, Spanish, Chinese Simplified <ul style="list-style-type: none"> <li>• Software download (email address required for delivery)</li> </ul>	<b>6SL3070-4LA02-0XG0</b>
<b>SINAMICS DCC V20 for TIA Portal incl. Floating</b> as an option package for SINAMICS Startdrive Basic or Advanced V20 Combo license key (floating license) German, English, French, Italian, Spanish, Chinese Simplified <ul style="list-style-type: none"> <li>• On DVD-ROM with license key on USB flash drive</li> <li>• Software download incl. license key (email address required for delivery)</li> </ul>	<b>6SL3070-4LA01-0XA5</b> <b>6SL3070-4LA01-0XG5</b>
<b>Upgrade SINAMICS DCC V15.1 ... V19 to V20</b> <ul style="list-style-type: none"> <li>• On DVD-ROM with license key on USB flash drive</li> <li>• Software download incl. license key (email address required for delivery)</li> </ul>	<b>6SL3070-4LA01-0XE5</b> <b>6SL3070-4LA01-0XK5</b>
<b>Software Update Service with SINAMICS DCC in the TIA Portal <sup>1)</sup></b> Delivery is performed according to the number of ordered SUS products (e.g. 10 upgrade license keys with 10 DVD-ROMs, 10 USB flash drives, etc.) <ul style="list-style-type: none"> <li>• On DVD-ROM with license key on USB flash drive</li> <li>• Software download incl. license key (email address required for delivery)</li> </ul>	<b>6SL3070-4AA01-0XL8</b> <b>6SL3070-4AA01-0XY8</b>

#### DCB Extension

With DCB Extension, additional libraries can be added as specifically programmed blocks to the standard block library at SINAMICS S120/S150/G130/G150/MV drive systems and SIMATIC Drive Controller. As a result, complex tasks can be implemented in the drive and the internal know-how protection can be increased as a Black Box. These blocks or libraries are programmed with the separate SINAMICS DCB Studio development tool in the C/C++ high-level language and can be used as a DCB Extension library for SINAMICS DCC in the TIA Portal and SINAMICS DCC in STARTER. The use of these blocks from DCB Extension libraries requires a SINAMICS DCB Extension runtime license.

#### SINAMICS DCB Extension license

Runtime license for re-licensing as of firmware V4.6 for the use of additional blocks/libraries (can also be ordered together with the CompactFlash card, see CompactFlash card for the Control Units CU310-2 and CU320-2) 6SL3077-0AA00-0AH0

#### SINAMICS DCB Studio V2.3 SP1

Development tool for programming blocks that can be imported as an additional library (DCB Extension) for SINAMICS DCC in the TIA Portal or in STARTER (upon request)

#### More information

TIA Portal highlights  
[www.siemens.com/tiaportal](http://www.siemens.com/tiaportal)

The SINAMICS DCC option package as trial version is available free on the internet at  
[www.siemens.com/startdrive](http://www.siemens.com/startdrive)

<sup>1)</sup> See Software Update Service section.



## Services and documentation

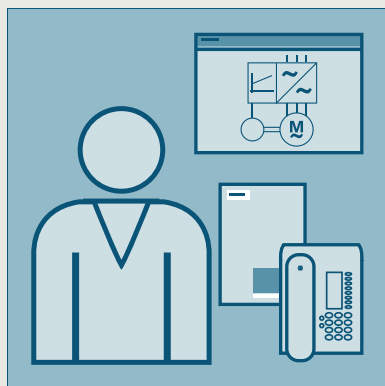

4/2	<b>Partner</b>
4/3	<b>Digital Enterprise Services</b>
4/4	<b>Training</b>
4/4	SITRAIN
4/6	Training courses for SINAMICS low-voltage converters
4/7	SINAMICS G220 training case
4/8	<b>Switchgear</b>
4/11	<b>Applications</b>
4/12	<b>Drives Options Partner</b>
4/13	<b>mySupport documentation</b>
4/14	<b>Documentation</b>
4/14	General documentation
4/15	SINAMICS G220 documentation

# Services and documentation

## Partner

### Overview

#### Partner at Siemens

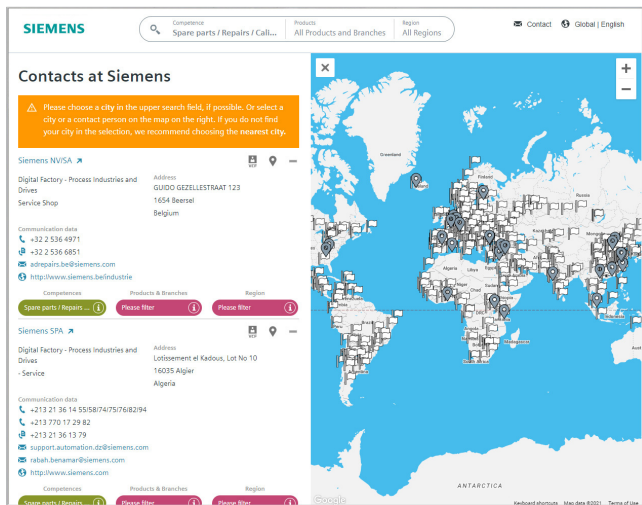

At your service locally, around the globe for consulting, sales, training, service, support, spare parts on the entire portfolio of Siemens.

Your partner can be found in our Personal Contacts Database at: [www.siemens.com/automation-contact](http://www.siemens.com/automation-contact)

You start by selecting

- the required competence,
- products and branches,
- a country and a city

or by a

location search or free text search.

**Overview**

# Digital Enterprise Services

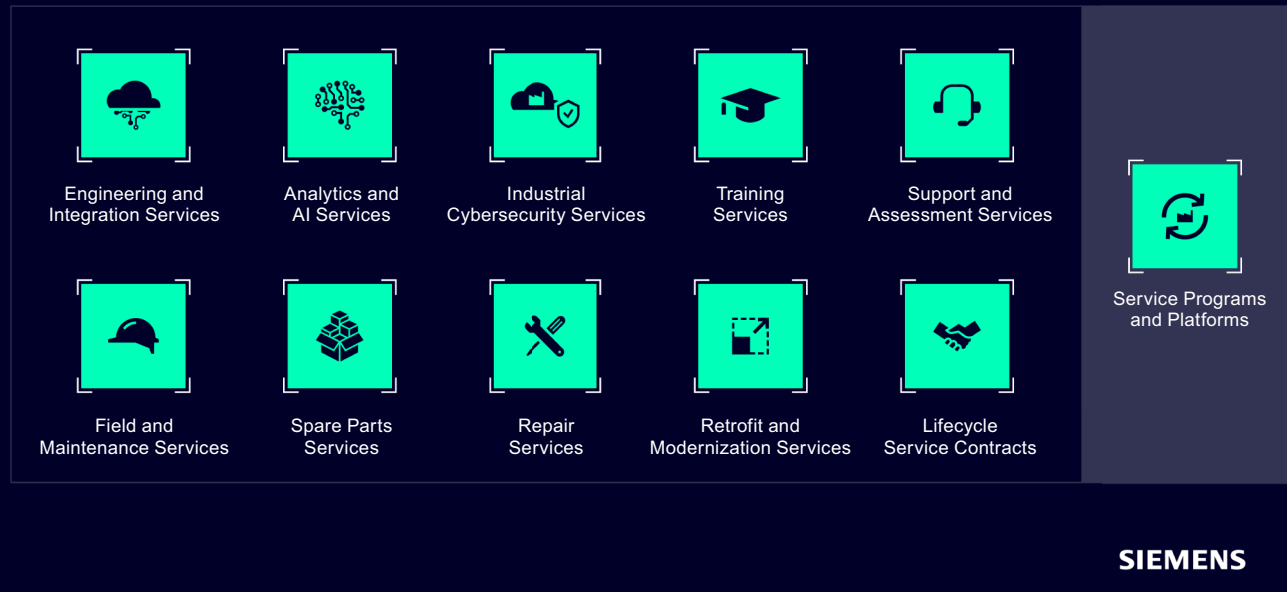

At Digital Enterprise Services, we provide you with comprehensive services throughout the entire lifecycle. From a fully digital factory to a reliable spare parts supply and quick support in the event of outages, we work with our partners to ensure your plant operates optimally – improving availability, productivity, and efficiency.

Our services take industry to the next level and give you a competitive edge:

- Services for Digital Transformation:**  
 Our innovative and scalable services streamline operations by optimizing your Overall Equipment Effectiveness (OEE), increasing productivity, preventing outages and improving business continuity – all while supporting IT/OT convergence.
- Services for Sustainability:**  
 Our optimization and lifetime extension services help make your sustainability goals a reality by providing data-driven insights into energy use, enabling you to reduce your carbon footprint and costs. By enabling a circular economy and focusing on product safety, cybersecurity, and supply chain visibility, we extend asset life, save resources, and improve operational efficiency.
- Lifecycle Services:**  
 Our innovative Lifecycle Services provide reliable support worldwide, offering tailored solutions throughout their entire lifecycle. By optimizing maintenance processes, we improve asset performance, efficiency, reliability, and productivity – from machines to entire plants or factories.

For more information, please visit us at:

[www.siemens.com/digital-enterprise-services](http://www.siemens.com/digital-enterprise-services)

[www.siemens.com/find-your-service](http://www.siemens.com/find-your-service)

## Services and documentation

### Training

#### SITRAIN

#### Introduction

##### *Learn the way you like it – with SITRAIN*

SITRAIN imparts a wide range of technical knowledge for all industries and applications. Our offering is oriented toward the needs of learners and the demands of innovative companies. Get pleasure out of learning - thanks to innovative learning methods, personal support, and knowledge that will help you in your work and further development. For successful, flexible, and continuous learning.

##### *Education and training directly from the manufacturer*

SITRAIN provides you with training from the industrial product and solution portfolio from Siemens and benefits from 30 years of expertise in technical training. Take a look at the many options for expanding your knowledge with SITRAIN and find the course that meets your needs! The following training and further education units are available to you for your individual knowledge building:



#### Industrial Automation Systems SIMATIC

Training available for: SIMATIC S7-1500, TIA Portal, SIMATIC S7-300/400, SIMATIC S7-1200



#### Drive Technology

Training available for: SINAMICS S120 and SINAMICS G120 low-voltage converters, SINAMICS G130 / G150 / G180 / S150

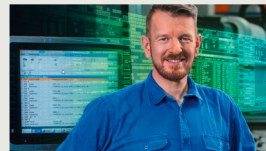

#### SINUMERIK CNC automation system

Training available for: SINUMERIK 840D, SINUMERIK 840D sl and SINUMERIK ONE



#### Process Control Systems

Training available for: SIMATIC PCS 7, SIMATIC PCS neo



#### Digital Enterprise

Training available for: Openness, SIMIT, OPC UA, Industrial Edge, Virtual commissioning



#### Industrial Communications

Training available for: PROFINET, SCALANCE, RUGGEDOM, Industrial Ethernet, Fieldbus communication, Industrial Security, Remote communication

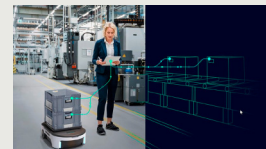

#### Identification and Locating

Training available for: RFID, RTLS-Systems



#### Operator Control and Monitoring Systems

Training available for: SIMATIC WinCC Unified in TIA Portal, SIMATIC WinCC in TIA Portal, SIMATIC WinCC V7x



#### Motion Control System SIMOTION

Training available for: SIMOTION (Programming, Commissioning, Diagnostics, Service)



#### Smart Infrastructure

Training available for: SIRIUS, SENTRON, SIVACON, ALPHA, SIMOCODE, Circuit breakers



#### Process Analytics & Instrumentation

Training is available for process analytics and instrumentation, explosion protection, process gas chromatographs



#### Additional training offer

SIMOVE with Automated Guided Vehicles (AGV), SIPLUS CMS, Guidelines and standards for control cabinets

**Introduction**

**Different learning formats and methods for maximum learning success**

With our SITRAIN training formats, you learn in the way that best suits your preferences and routine. You decide whether you would rather take online training or face-to-face training. It is up to you whether you would like to study on demand or at fixed times.

With a personal learning consultant, in the team, or on your own – you can explore all the possibilities.

Discover our three learning formats:



**Learning Event**

SITRAIN Learning Events are the perfect choice when you want to achieve a defined learning goal in the shortest possible time. You learn in a protected learning environment outside of the daily work routine under the guidance of a learning consultant - virtually, in the training center, or at your company.



**Learning Membership  
SITRAIN Access**

With SITRAIN access, you enter a world of extensive and constantly expanding self-study units on our digital learning platform for industry. With SITRAIN access, you can implement a modern learning culture in your team or company with independent and continuous learning.



**Learning Journey**

The Learning Journey is the perfect combination of units taken live and self-study units for sustainable learning success. The modular approach enables simple integration into your daily work. This also includes one-year membership for using the SITRAIN access digital learning platform.

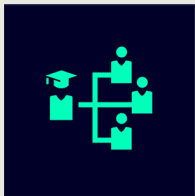

**Live**

Learn together with others, simultaneously and guided by a learning consultant. Online, in the SITRAIN training center or at your company.

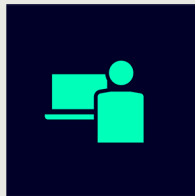

**Self-reliant**

Expand your knowledge self-determined with industry learning and work on your learning units at your own pace and according to your own schedule.

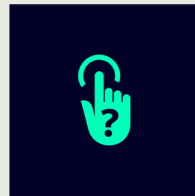

**On demand**

Get the knowledge you need, exactly when you need it. Be it to answer a current question or to work on a special topic.

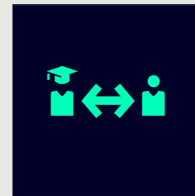

**Individual**

Talk directly with the learning consultant, clarify detailed questions and get personal coaching for transferring the learned topics to your own application.



**Training cases catalog**

<https://www.siemens.com/sitrain-catalog-training-cases>

[www.siemens.com/sitrain](http://www.siemens.com/sitrain)

Find your local offer here





## Services and documentation

### Training

#### Training courses for SINAMICS low-voltage converters

##### Overview

##### Training courses for SINAMICS drive system



This provides an overview of the training courses available for the SINAMICS drive system.

The courses are modular in design and are directed at a variety of target groups as well as individual customer requirements.

The system overview will acquaint decision-makers and sales personnel with the system very quickly.

The engineering course provides all the information you need to configure the drive system.

The courses dedicated to diagnostics and servicing, parameterization and commissioning, communication as well as extended functions such as Safety Integrated are sure to provide all the technical knowledge service engineers will need.

All courses contain as many practical exercises as possible to enable intensive and direct training on the drive system and with the tools in small groups.

Please also take note of the training options available for SIMOTICS motors. You will find more information about course contents and dates on the internet.

Title (all courses are available in English and German)	Target group			Duration	Order code
	Planners, decision-makers, sales personnel	Commissioning engineers, configuring engineers	Service personnel, maintenance technicians		
<b>Course Fundamentals and overview</b>					
SINAMICS and SIMOTICS – Basics of Drive Technology	✓	✓	✓	5 days	DR-BASIC
<b>Courses SINAMICS S120</b>					
SINAMICS S120 Parameterizing and Commissioning with STARTER	–	✓	–	5 days	DR-S12-PM
SINAMICS S120 Parameterizing and Commissioning in the TIA Portal	–	✓	–	5 days	DR-S12-PMT
SINAMICS S120 Parameterizing Safety Integrated	–	✓	–	4 days	DR-S12-SAF
SINAMICS S120 Parameterizing and Optimization	–	✓	–	5 days	DR-S12-OPT
SINAMICS S120 Diagnostics and Service	–	–	✓	5 days	DR-S12-DG
SINAMICS S120 Diagnostics and Service in the TIA Portal	–	–	✓	5 days	DR-S12-DGT
SINAMICS S120 Diagnostics on Chassis and Cabinet Units	–	✓	✓	3 days	DR-S12-CHA
<b>Course SINAMICS S210</b>					
SINAMICS S210 – Commissioning and Service	–	✓	✓	2 days	DR-S210
<b>Course SINAMICS G120 (including SINAMICS G120X, SINAMICS G120D and SINAMICS G115D)</b>					
Parameterizing and Commissioning	–	✓	–	2 days	DR-G12-PM
<b>Courses SINAMICS G130/G150/G180/S150</b>					
SINAMICS G150/G130/S150 - Diagnostics and Service	–	✓	✓	5 days	DR-G15-DG
SINAMICS G180 – Parameterization and Service	–	–	✓	2.5 days	DR-G180
<b>Course SINAMICS G220</b>					
SINAMICS G220 – Commissioning and Service	–	✓	✓	3 days	DR-G220



**Overview****SINAMICS G220 training case**

SINAMICS G220 training case

The SINAMICS G220 training case is a convincing demonstration system thanks to its compact design. It is suitable for direct customer presentations as well as for tests in technical departments. It enables the functions of SINAMICS G220 to be demonstrated and tested quickly and easily.

It contains the following components:

- SINAMICS G220 frequency converter, PROFINET, EtherNet/IP, Modbus TCP/IP, 230 V, 0.55 kW
- SIMATIC S7-1511F PN PLC
- Asynchronous motor, IE3, 0.12 kW
- SINAMICS Smart Adapter (Wi-Fi adapter)
- SINAMICS OM-DQ Option Module DRIVE-CLiQ
- SINAMICS OM-SMT Option Module Safe Motor Temperature (ATEX safe)
- Internal galvanic isolation module

The SINAMICS G220 training case is supplied as a trolley with a removable hood.

**Selection and ordering data**

Description	Article No.
<b>SINAMICS G220 training case</b>	<b>6AG1067-1AA36-0AA0</b>
<b>Accessories</b>	
<b>SINAMICS G220 synchronous reluctance motor case</b>	<b>6AG1067-1AA41-0AA0</b>

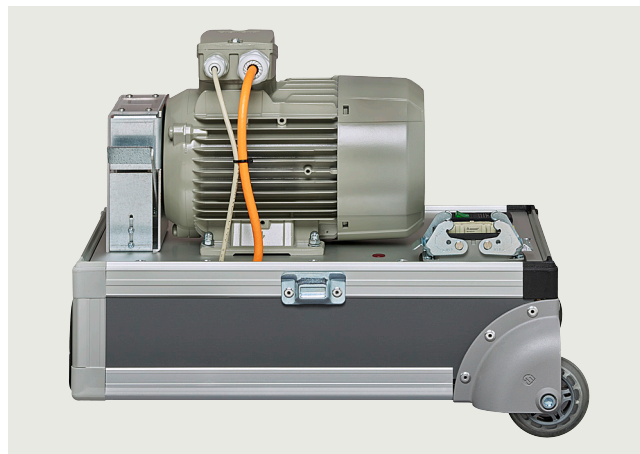
**Accessories****SINAMICS G220 synchronous reluctance motor case**

SINAMICS G220 synchronous reluctance motor case

The case serves as a supplement to the SINAMICS G220 training case for applications of synchronous reluctance motors. Together, both cases are used for training and acquisition of the SINAMICS G220 vector control drive system. They are also suitable for use in laboratory testing.

It contains the following components:

- Synchronous reluctance motor, 0.55 kW
- SINAMICS Motor Control Extended (licence)
- Internal galvanic isolation module

The SINAMICS G220 synchronous reluctance motor case is supplied as a trolley with a removable hood.

**Technical specifications**

	<b>SINAMICS G220 training case</b>	<b>SINAMICS G220 synchronous reluctance motor case</b>
	6AG1067-1AA36-0AA0	6AG1067-1AA41-0AA0
<b>Supply voltage</b>	230 V 1 AC	230 V 1 AC
<b>Dimensions</b>		
• Width	570 mm (22.46 in)	380 mm (14.97 in)
• Height	320 mm (12.61 in)	430 mm (16.94 in)
• Depth	350 mm (13.79 in)	300 mm (11.82 in)
<b>Weight, approx.</b>	16.2 kg (35.7 lb)	22 kg (48.5 lb)

## Services and documentation

### Switchgear

#### Overview

##### **Systems Engineering Plant Chemnitz (WKC) - Electrical equipment for machines and plants**

The Siemens Systems Engineering Plant Chemnitz (WKC) is the European market leader in control cabinet construction for machine tools and manufactures equipment for numerous segments the machine and plant construction industry, as well as for project business in the logistics and automotive sectors.



WKC - Control cabinet wiring

##### **Scope of services offered**

The WKC offers a complete portfolio of services for development and production: From concept support and hardware engineering, construction including complete material procurement to testing, advance commissioning support and worldwide in-bound delivery. Each customer decides individually what extent of these services the WKC is to provide.



WKC - Engineering - SSB

##### **Competence center for standardization and air conditioning**

The WKC is also competence center for the air conditioning of switchgear, has its own test laboratory, and is a certified UL Panels shop. Siemens WKC therefore is happy to support you with advice on design in accordance with standards and concepts for your drive systems, control, operation and safety. In addition, our engineers configure for you in EPLAN and other CAD systems, execute Design-To-Cost projects, and adapt your documents where necessary to UL or new automation and digitalization technologies.



WKC - Test laboratory - Heat measurement

### Overview

#### Individual support and maximum flexibility

Our technical consultants for complete equipment support customers and sales departments in the various regions. Our customers are supported by job centers and permanently assigned manufacturing teams. As a customer, you will benefit from individual logistics models, flexible production capacities and production areas, change management in all process phases, as well as maximum flexibility for your orders..

Distance is no problem: For coordination with our customers, we use various digital communication and business applications with user-friendly and powerful functions for screensharing, videoconferencing, file transfer, as well as all options for a customer acceptance via webcam (mobile circuit meeting room).



WKC - Automated testing SICAT

#### Your advantages

We offer complete services from a single source with Siemens quality and stability, extensive specialist support, and flexible resources. We will be glad to accompany you into international markets as well. With us you have a strong partner at your side - from the design stage to final delivery. Whether for series or individual units, Siemens WKC works together with you to implement your projects according to your requirements.

#### Overview of the portfolio of services

##### Order coordination

- Project manager with permanent customer assignment
- Complete material purchasing
- Change management in all process phases

##### Manufacturing

- Creation of a digital twin
- CNC processing of enclosure parts and mounting plates
- In-house painting
- Auto-routing of the wiring
- Automated prefabrication of cables
- Production teams with permanent customer assignment
- Batch or flow production

##### Automated test (standard)

- Current path test
- Function of switching, operating and signaling devices
- Observance of protective measures and safety

##### Optional test services / pre-commissioning

- Error-free function of the programmable controllers / I/O devices
- Parameterization and checking of bus systems
- First commissioning of Siemens NC and PLC
- Installation of customer software



WKC - Collaborative robotics



## Services and documentation

### Switchgear

#### Overview

##### **Additional services for different project phases**

Our portfolio is supplemented by a host of additional services for many different project phases.

##### Planning

- Evaluation of requirement specifications, requirements
- Advice regarding standard applications and certifications (conformity)
- Advice regarding EMC, air conditioning, and electrical safety
- Design-To-Cost analyses
- Special rated conditions

##### Implementation/realization

- Creation of an electrical design in various CAE systems
- Creation of an air conditioning design through calculation and simulation
- CAE revision of production documents

##### Validation/certification

- International standard and certification know-how, e.g.: IEC 60204-1, IEC 61439, UL or cULus
- Checking of air conditioning / EMC designs in own Siemens laboratory or at customer premises
- Execution of EMC precompliance measurements in own laboratory or at your plant location

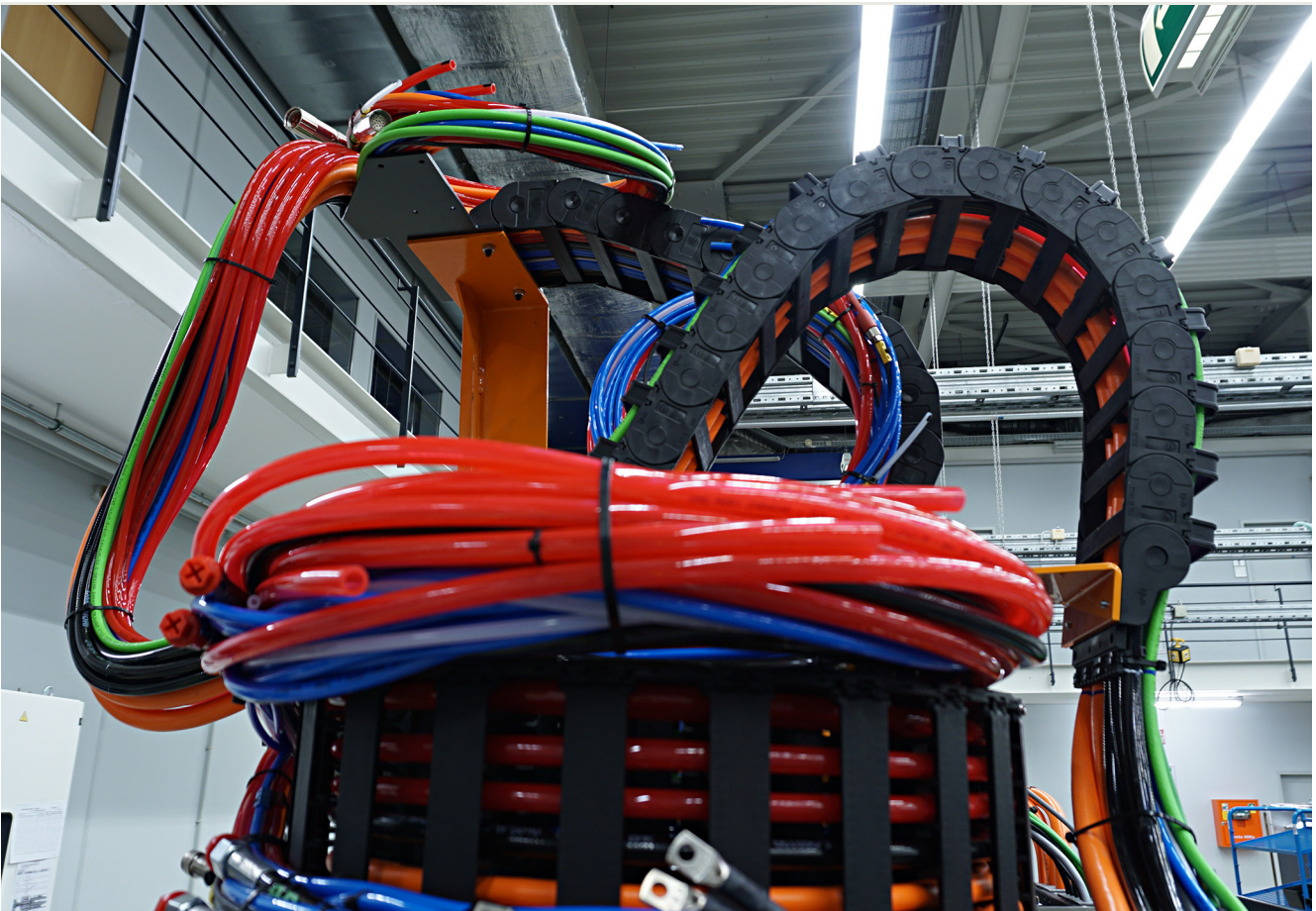

WKC - Additional service - Festoon cable system

#### More information

You can find additional information on the internet at:

[www.siemens.com/panelbuilding](http://www.siemens.com/panelbuilding)

Or contact us by

email: [info.wkc.industry@siemens.com](mailto:info.wkc.industry@siemens.com)

### Overview



Our understanding of an application is the customer-specific solution of an automation task based on standard hardware and software components. In this respect, industry knowledge and technological expertise are just as important as expert knowledge about how our products and systems work. We are setting ourselves this challenge with more than 280 application engineers in 20 countries.

#### Application centers

We currently have application centers in:

- Germany: Head Office in Erlangen and in other German regions, e.g. in Munich, Nuremberg, Stuttgart, Mannheim, Frankfurt, Chemnitz, Cologne, Bielefeld, Bremen, Hanover, Hamburg
- Belgium: Brussels
- Brazil: Sao Paulo
- China: Beijing and 12 regions
- Denmark: Ballerup
- France: Paris
- Great Britain: Manchester
- India: Mumbai
- Italy: Bologna, Milan
- Japan: Tokyo, Osaka
- The Netherlands: The Hague
- Austria: Vienna
- Poland: Warsaw
- Sweden: Göteborg
- Switzerland: Zurich, Lausanne
- Spain: Madrid
- South Korea: Seoul
- Taiwan: Taipei
- Turkey: Istanbul
- USA: Atlanta

These application centers specialize in the use of SIMATIC/SIMOTION/SINAMICS. You therefore can rely on automation and drive specialists for implementing successful applications. By involving your personnel at an early stage in the process, we can provide a solid basis for rapid knowledge transfer, maintenance and further development of your automation solution.

#### Advice on applications and implementation

We offer a variety of consultation services to help you find the optimum solution for the SIMATIC/SIMOTION/SINAMICS application you want to implement:

The quotation phase includes

- clarification of technical questions,
- discussion of machine concepts and customer-specific solutions,
- selection of suitable technology and
- suggestions for implementation.

A technical feasibility study is also performed at the outset. In this way, difficult points of the application can be identified and solved early on. We can also configure and implement your application as a complete solution from a single source.

A large number of proven standard applications are available for use during the implementation phase. This saves engineering costs.

The system can be commissioned by experienced, competent personnel, if required. This saves time and trouble.

If servicing is required, we can support you on site or remotely. For further information about servicing, please see the section "Industry Services".

#### On-site application training

Training for the implemented applications can also be organized and carried out on site. This training for machine manufacturers and their customers does not deal with individual products, but the entire hardware and software system (for example, automation, drives and visualization).

From an initial concept to successful installation and commissioning: We provide complete support for SIMATIC/SIMOTION/SINAMICS! Contact your Siemens representative.

You can find further information at [www.siemens.com/machinebuilding](http://www.siemens.com/machinebuilding)

## Services and documentation

### Drives Options Partner

#### Overview

##### Siemens Product Partners for Drives Options

###### Individual options for our drives

In order to meet as many customer requirements as possible in the field of drive technology, in addition to its own products, Siemens also relies on the individual and complementary services of selected partners.

We are increasingly focusing on the standard drive options, and our Siemens Product Partners for Drives Options supplement our drives with individual drive options.

This gives Siemens a unique flexibility to meet all application requirements. Naturally, we support our Siemens Product Partners for Drives Options in tailoring their options perfectly to our drives.

For you as our customer, there are multiple benefits:

- The Siemens Product Partners for Drives Options meet the same high standards of quality and performance that we place on our own products
- Drive options can be adapted to individual requirements/designs
- The Siemens Product Partners for Drives Options know our Siemens converter portfolio and can advise you individually and quickly

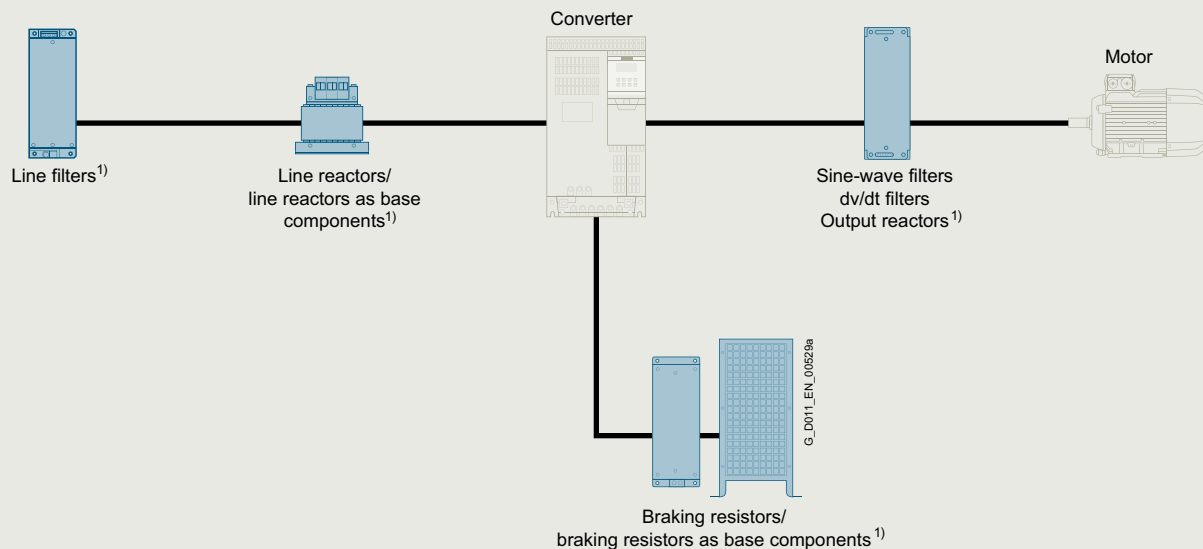

<sup>1)</sup> Options that can be supplied from Siemens as well as from Product Partners for Drives Options.

Schematic circuit diagram

#### More information

You can find more information on the internet at [www.siemens.com/drives-options-partner](http://www.siemens.com/drives-options-partner)



### Overview

#### mySupport documentation – Compiling personal documents

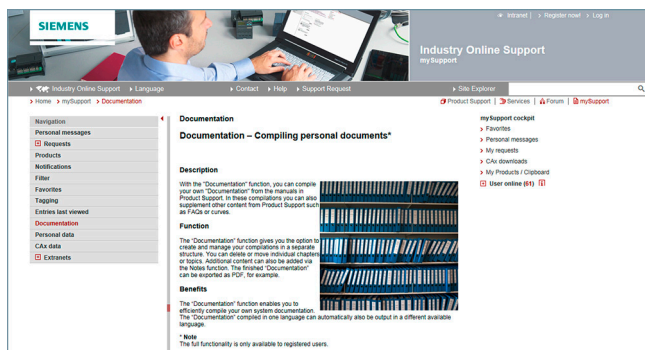

mySupport documentation is a web-based system for generating personalized documentation based on standard documents and is part of the Siemens Industry Online Support portal.

In mySupport, a personal document library can be created in the "Documentation" category. This library can be accessed online in mySupport or also be generated in various formats for offline use.

Previously, this functionality was available in the My Documentation Manager for configurable manuals. Due to the integration in mySupport, all entries of the Industry Online Support can now be imported into the personal document library, including FAQs or product notifications.

If you have already worked with the My Documentation Manager, all of the previously created libraries will continue to be available without restrictions in mySupport.

In addition, the personal library in mySupport can be shared with other mySupport users. In this way, a collection of relevant documents can be created very effectively and used together with other mySupport users all over the world.

You must register/log in for configuring and generating/managing.

### Benefits

- Display  
View, print or download standard documents or personalized documents
- Configure  
Transfer standard documents or parts of them to personalized documents
- Generate/Manage  
Generate and manage personalized documents in the formats PDF, RTF or XML in all available languages

### Function

#### Opening mySupport documentation in the Industry Online Support portal

- About the product support, entry type "Manual":  
<https://support.industry.siemens.com/cs/ww/en/ps/man>  
By clicking on the required version of the manual and then "Show and configure", the manual opens in a modular view, where you can navigate from topic to topic. Here the direct link to a topic can be used and made available to other users. The selected document can be added to the personal library via "mySupport Cockpit" > "Add to mySupport documentation".
- Via the direct link  
<https://support.industry.siemens.com/my/ww/en/documentation/advanced>  
After logon/registration, the online help is displayed as the current document.

### More information

You can find additional information on the internet at

- <https://support.industry.siemens.com/my/ww/en/documentation>
- [https://support.industry.siemens.com/cs/helpcenter/en/index.htm?#persoenliche\\_bibliothek\\_aufbauen.htm](https://support.industry.siemens.com/cs/helpcenter/en/index.htm?#persoenliche_bibliothek_aufbauen.htm)

## Services and documentation

### Documentation

#### General documentation

##### Overview

A high-quality programmable control or drive system can be used to maximum effect only if the user is aware of the performance of the products used as a result of intensive training and good technical documentation.

This is becoming more important due to the shorter innovation cycles of modern automation products and the convergence of electronics and mechanical engineering.

A comprehensive range of documentation is available which includes a Getting Started guide, operating instructions, installation manuals and a list manual.

In addition to technical information for SINUMERIK, SINAMICS, SIMOTION and SIMOTICS, the documentation is available for downloading as a PDF file from the internet:

- SINUMERIK  
<https://support.industry.siemens.com/cs/document/108464614>
- SINAMICS  
<https://support.industry.siemens.com/cs/document/109807358>
- SIMOTION  
<https://support.industry.siemens.com/cs/document/109479653>
- SIMOTICS  
<https://support.industry.siemens.com/cs/document/109813641>

##### Selection and ordering data

Description	Article No.
<b>Automating with PROFINET: Industrial Communication Based on Industrial Ethernet</b> <ul style="list-style-type: none"> <li>• German</li> <li>• English</li> </ul>	Via bookstore  <b>ISBN 978-3-89578-293-0</b> <b>ISBN 978-3-89578-294-7</b>

##### Application

###### Explanations of the manuals:

- **Operating Instructions**  
contain all the information needed to install the device and make electrical connections, information about commissioning and a description of the converter functions.  
Phases of use: Control cabinet construction, commissioning, operation, maintenance and servicing.
- **Hardware Installation Manual**  
contains all relevant information about the intended use of the components of a system (technical specifications, interfaces, dimensional drawings, characteristics, or possible applications), information about installation and electrical connections and information about maintenance and servicing.  
Phases of use: Control cabinet configuration/construction, maintenance and servicing.
- **Operating and Installation Instructions (for converter and accessories)**  
contain all relevant information about the intended use of the components, such as technical specifications, interfaces, dimensional drawings, characteristics, or possible applications.  
Phases of use: Control cabinet configuration/construction.
- **Manual/Configuration Manual**  
contains all necessary information about the intended use of the components of a system, e.g. technical specifications, interfaces, dimensional drawings, characteristics, or possible applications.  
Phases of use: Cabinet configuration/setup, circuit diagram configuration/drawing.
- **Commissioning Manual**  
contains all information relevant to commissioning after installation and wiring. It also contains all safety and warning notices relevant to commissioning in addition to overview drawings.  
Phases of use: Commissioning of components that have already been connected, configuration of system functions.
- **List Manual**  
contains all parameters, function diagrams, and faults/alarms for the product/system as well as their meanings and setting options. It contains parameter data and fault/alarm descriptions with functional correlations.  
Phases of use: Commissioning of components that have already been connected, configuration of system functions, fault cause/diagnosis.
- **Getting Started**  
provides information about getting started for the first-time user as well as references to additional information. It contains information about the basic steps to be taken during commissioning. The information in the other documentation should be carefully observed for all of the other work required.  
Phases of use: Commissioning of components that have already been connected.
- **Function Manual Drive Functions**  
contains all the relevant information about individual drive functions: Description, commissioning and integration in the drive system.  
Phases of use: Commissioning of components that have already been connected, configuration of system functions.

## Overview

### Identification link according to IEC 61406 for SINAMICS G220

The ID link contains the article and serial number of the product. As a QR code, it replaces the previous data matrix code on the nameplate and takes you with the URL directly to a product information page on the internet with access to the technical documentation, data sheet, certificates, FAQs, product notifications, and catalogs. Paper package inserts become superfluous since the information is available electronically directly via the QR code, even years later. In this way, we are making a valuable contribution to the preservation of our environment. You don't need an additional app. Simply scan the QR code with your smartphone or tablet. According to IEC 61406, the QR code of an ID link is marked with a frame and a triangle at the bottom right.

With their globally unique identifiers, Siemens products are ready for Industry 4.0.

The ID serves as a connection to the administration shell with which modules of the digital twin can be provided.

Further documentation, such as the operating instructions, is available free on the internet at:

[www.siemens.com/sinamics-g220/documentation](http://www.siemens.com/sinamics-g220/documentation)

Detailed information on the SINAMICS G220 built-in and wall-mounted units, including the latest technical documentation (brochures, tutorials, dimensional drawings, certificates and operating instructions), is available on the internet at:

[www.siemens.com/sinamics-g220](http://www.siemens.com/sinamics-g220)

and is also available via the Siemens Product Configurator on the internet.

The Siemens Product Configurator can be found in the Siemens Industry Mall at the following address:

[www.siemens.com/spc](http://www.siemens.com/spc)

### Environmental Product Declaration (EPD)

Environmental Product Declarations (EPD) are available as PDFs for this product.

The EPD PDF provides brief and concise information about the ecological properties of a product.

You can find more information on the internet at:  
<https://support.industry.siemens.com/cs/ww/en/ps/28308/cert?ci=5690>

## Services and documentation

### Notes

## Appendix



5/2	<b>Certificates of suitability (approvals)</b>
5/4	<b>Software licenses</b>
5/6	<b>Conversion tables</b>
5/9	<b>Conditions of sale and delivery</b>

## Appendix

### Certificates of suitability (approvals)







#### Overview

Many of the products in this catalog fulfill requirements, e.g. for UL, CSA or FM and are labeled with the corresponding approval designation.

All of the certificates of suitability, approvals, certificates, declarations of conformity, test certificates, e.g. CE, UL, Safety Integrated etc. have been performed with the associated system components as they are described in the Catalogs and Configuration Manuals.

The certificates are only valid if the products are used with the described system components, are installed according to the Installation Guidelines and used for their intended purpose.





In other cases, the vendor of these products is responsible for arranging for the issue of new certificates.

Test code	Tested by	Device series/ Component	Test standard	Product category/ File No.
<b>UL: Underwriters Laboratories</b> Independent public testing body in North America				
	UL according to UL standard	SINUMERIK	Standard UL 508, CSA C22.2 No. 142	NRAQ/7.E164110 NRAQ/7.E217227
		SIMOTION	Standard UL 508, CSA C22.2 No. 142	NRAQ/7.E164110
	UL according to CSA standard	SINAMICS	Standard UL 508, 508C, 61800-5-1 CSA C22.2 No. 142, 274	NRAQ/7.E164110, NMMS/2/7/8.E192450, NMMS/2/7/8.E203250, NMMS/7.E214113, NMMS/7.E253831
				NMMS/2/7/8.E121068 NMMS/7.E355661 NMMS/7.E323473
	UL according to UL and CSA standards			
	UL according to UL standard	SIMODRIVE	Standard UL 508C, CSA C22.2 No. 274	NMMS/2/7/8.E192450 NMMS/7.E214113
	UL according to CSA standard	SIMOTICS	Standard UL 1004-1, 1004-6, 1004-8, CSA C22.2 No. 100	PRGY2/8.E227215 PRHZ2/8.E93429 PRHJ2/8.E342747
				PRGY2/8.E253922 PRHZ2/8.E342746
	UL according to UL and CSA standards			
		Line/motor reactors	Standard UL 508, 506, 5085-1, 5085-2, 1561, CSA C22.2 No. 14, 47, 66.1-06, 66.2-06	XQNX2/8.E257859 NMTR2/8.E219022 NMMS2/8.E333628 XPTQ2/8.E257852 XPTQ2/8.E103521 NMMS2/8.E224872 XPTQ2/8.E354316 XPTQ2/8.E198309 XQNX2/8.E475972
		Line filters, dv/dt filters, sine-wave filters	UL 1283, CSA C22.2 No. 8	FOKY2/8.E70122
		Resistors	UL 508, 508C, CSA C22.2 No. 14, 274	NMTR2/8.E224314 NMMS2/8.E192450 NMTR2/8.E221095 NMTR2/8.E226619
<b>TUV: TÜV Rheinland of North America Inc.</b> Independent public testing body in North America, Nationally Recognized Testing Laboratory (NRTL)				
<b>TÜV: TÜV SÜD Product Service</b> Independent public testing body in Germany, Nationally Recognized Testing Laboratory (NRTL) for North America				
	TUV according to UL and CSA standards	SINAMICS	NRTL listing according to standard UL 508C	U7V 12 06 20078 013 U7 11 04 20078 009 U7 11 04 20078 010 U7 11 04 20078 011
		SIMOTION	NRTL listing according to standard UL 508	U7V 13 03 20078 01
		SIMODRIVE	NRTL listing according to standard UL 508C, CSA C22.2. No. 14	CU 72090702
		Motion Control Encoder	NRTL listing according to UL 61010-1 CSA C22.2 No. 61010-1	U8V 10 06 20196 024



## Certificates of suitability (approvals)

## Overview

Test code	Tested by	Device series/ Component	Test standard	Product category/ File No.
<b>CSA: Canadian Standards Association</b> Independent public testing body in Canada				
	CSA according to CSA standard	SINUMERIK	Standard CSA C22.2 No. 142	2252-01 : LR 102527
<b>FMRC: Factory Mutual Research Corporation</b> Independent public testing body in North America				
	FM according to FM standard	SINUMERIK	Standard FMRC 3600, FMRC 3611, FMRC 3810, ANSI/ISA S82.02.1	–
<b>EAC:</b> Independent public testing body within the Eurasian Conformity Area				
	EAC in accordance with the EAC Directive	SINAMICS SINUMERIK SIMOTION	Standard IEC 61800-5-1/-2, IEC 61800-3	–
<b>RCM: Australian Communications and Media Authority</b> Independent public testing body in Australia				
	RCM according to EMC standard	SINAMICS SINUMERIK SIMOTION	Standard IEC AS 61800-3, EN 61800-3	–
<b>KC: National Radio Research Agency</b> Independent public testing body in South Korea				
	KC according to EMC standard	SINAMICS SINUMERIK SIMOTION	Standard KN 11	–
<b>BIA</b> Federal Institute for Occupational Safety				
–	Functional safety	SINAMICS SINUMERIK SIMOTION	Standard EN 61800-5-2	–
<b>TÜV SÜD Rail</b>				
–	Functional safety	SINAMICS SINUMERIK SIMOTION	Standard EN 61800-5-2	–

More information about certificates can be found online at:  
<https://support.industry.siemens.com/cs/ww/en/ps/cert>

## Appendix

### Software licenses

#### Overview

##### **Software types**

Software requiring a license is categorized into types. The following software types have been defined:

- Engineering software
- Runtime software

##### **Engineering software**

This includes all software products for creating (engineering) user software, e.g. for configuring, programming, parameterizing, testing, commissioning or servicing.

Data generated with engineering software and executable programs can be duplicated for your own use or for use by third-parties free-of-charge.

##### **Runtime software**

This includes all software products required for plant/machine operation, e.g. operating system, basic system, system expansions, drivers, etc.

The duplication of the runtime software and executable programs created with the runtime software for your own use or for use by third-parties is subject to a charge.

You can find information about license fees according to use in the ordering data (e.g. in the catalog). Examples of categories of use include per CPU, per installation, per channel, per instance, per axis, per control loop, per variable, etc.

Information about extended rights of use for parameterization/configuration tools supplied as integral components of the scope of supply can be found in the readme file supplied with the relevant product(s).

##### **License types**

Siemens Digital Industries and Smart Infrastructure offers various types of software license:

- Floating license
- Single license
- Rental license
- Rental floating license
- Trial license
- Demo license
- Demo floating license

##### **Floating license**

The software may be installed for internal use on any number of devices by the licensee. Only the concurrent user is licensed. The concurrent user is the person using the program. Use begins when the software is started. A license is required for each concurrent user.

##### **Single license**

Unlike the floating license, a single license permits only one installation of the software per license.

The type of use licensed is specified in the ordering data and in the Certificate of License (CoL). Types of use include for example per instance, per axis, per channel, etc.

One single license is required for each type of use defined.

##### **Rental license**

A rental license supports the "sporadic use" of engineering software. Once the license key has been installed, the software can be used for a specific period of time (the operating hours do not have to be consecutive).

One license is required for each installation of the software.

##### **Rental floating license**

The rental floating license corresponds to the rental license, except that a license is not required for each installation of the software. Rather, one license is required per object (for example, user or device).

##### **Trial license**

A trial license supports "short-term use" of the software in a non-productive context, e.g. for testing and evaluation purposes. It can be transferred to another license.

##### **Demo license**

The demo license support the "sporadic use" of engineering software in a non-productive context, for example, use for testing and evaluation purposes. It can be transferred to another license. After the installation of the license key, the software can be operated for a specific period of time, whereby usage can be interrupted as often as required.

One license is required per installation of the software.

##### **Demo floating license**

The demo floating license corresponds to the demo license, except that a license is not required for each installation of the software. Rather, one license is required per object (for example, user or device).

##### **Certificate of License (CoL)**

The CoL is the licensee's proof that the use of the software has been licensed by Siemens. A CoL is required for every type of use and must be kept in a safe place.

##### **Downgrading**

The licensee is permitted to use the software or an earlier version/release of the software, provided that the licensee owns such a version/release and its use is technically feasible.

##### **Delivery versions**

Software is constantly being updated. The following delivery versions

- PowerPack
- Upgrade

can be used to access updates.

Existing bug fixes are supplied with the ServicePack version.

##### **PowerPack**

PowerPacks can be used to upgrade to more powerful software. The licensee receives a new license agreement and CoL (Certificate of License) with the PowerPack. This CoL, together with the CoL for the original product, proves that the new software is licensed.

A separate PowerPack must be purchased for each original license of the software to be replaced.

##### **Upgrade**

An upgrade permits the use of a new version of the software on the condition that a license for a previous version of the product is already held.

The licensee receives a new license agreement and CoL with the upgrade. This CoL, together with the CoL for the previous product, proves that the new version is licensed.

A separate upgrade must be purchased for each original license of the software to be upgraded.

**Overview****ServicePack**

ServicePacks are used to debug existing products. ServicePacks may be duplicated for use as prescribed according to the number of existing original licenses.

**License key**

Siemens Digital Industries and Smart Infrastructure supplies software products with and without license keys.

The license key serves as an electronic license stamp and is also the "switch" for activating the software (floating license, rental license, etc.).

The complete installation of software products requiring license keys includes the program to be licensed (the software) and the license key (which represents the license).

**Software Update Service (SUS)**

As part of the SUS contract, all software updates for the respective product are made available to you free of charge for a period of one year from the invoice date. The contract will automatically be extended for one year if it is not canceled three months before it expires.

The possession of the current version of the respective software is a basic condition for entering into an SUS contract.

You can download explanations concerning license conditions from [https://mall.industry.siemens.com/legal/ww/en/terms\\_of\\_trade\\_en.pdf](https://mall.industry.siemens.com/legal/ww/en/terms_of_trade_en.pdf)

## Appendix

### Conversion tables

#### Rotary inertia (to convert from A to B, multiply by entry in table)

A \ B	lb-in <sup>2</sup>	lb-ft <sup>2</sup>	lb-in-s <sup>2</sup>	lb-ft-s <sup>2</sup> slug-ft <sup>2</sup>	kg-cm <sup>2</sup>	kg-cm-s <sup>2</sup>	gm-cm <sup>2</sup>	gm-cm-s <sup>2</sup>	oz-in <sup>2</sup>	oz-in-s <sup>2</sup>
lb-in <sup>2</sup>	1	$6.94 \times 10^{-3}$	$2.59 \times 10^{-3}$	$2.15 \times 10^{-4}$	2.926	$2.98 \times 10^{-3}$	$2.92 \times 10^3$	2.984	16	$4.14 \times 10^{-2}$
lb-ft <sup>2</sup>	144	1	0.3729	$3.10 \times 10^{-2}$	421.40	0.4297	$4.21 \times 10^5$	429.71	2304	5.967
lb-in-s <sup>2</sup>	386.08	2.681	1	$8.33 \times 10^{-2}$	$1.129 \times 10^3$	1.152	$1.129 \times 10^6$	$1.152 \times 10^3$	$6.177 \times 10^3$	16
lb-ft-s <sup>2</sup> slug-ft <sup>2</sup>	$4.63 \times 10^3$	32.17	12	1	$1.35 \times 10^4$	13.825	$1.355 \times 10^7$	$1.38 \times 10^4$	$7.41 \times 10^4$	192
kg-cm <sup>2</sup>	0.3417	$2.37 \times 10^{-3}$	$8.85 \times 10^{-4}$	$7.37 \times 10^{-5}$	1	$1.019 \times 10^{-3}$	1000	1.019	5.46	$1.41 \times 10^{-2}$
kg-cm-s <sup>2</sup>	335.1	2.327	0.8679	$7.23 \times 10^{-2}$	980.66	1	$9.8 \times 10^5$	1000	$5.36 \times 10^3$	13.887
gm-cm <sup>2</sup>	$3.417 \times 10^{-4}$	$2.37 \times 10^{-6}$	$8.85 \times 10^{-7}$	$7.37 \times 10^{-8}$	$1 \times 10^{-3}$	$1.01 \times 10^{-6}$	1	$1.01 \times 10^{-3}$	$5.46 \times 10^{-3}$	$1.41 \times 10^{-5}$
gm-cm-s <sup>2</sup>	0.335	$2.32 \times 10^{-3}$	$8.67 \times 10^{-4}$	$7.23 \times 10^{-5}$	0.9806	$1 \times 10^{-3}$	980.6	1	5.36	$1.38 \times 10^{-2}$
oz-in <sup>2</sup>	0.0625	$4.34 \times 10^{-4}$	$1.61 \times 10^{-4}$	$1.34 \times 10^{-5}$	0.182	$1.86 \times 10^{-4}$	182.9	0.186	1	$2.59 \times 10^{-3}$
oz-in-s <sup>2</sup>	24.13	0.1675	$6.25 \times 10^{-2}$	$5.20 \times 10^{-3}$	70.615	$7.20 \times 10^{-2}$	$7.09 \times 10^4$	72.0	386.08	1

#### Torque (to convert from A to B, multiply by entry in table)

A \ B	lb-in	lb-ft	oz-in	N-m	kg-cm	kg-m	gm-cm	dyne-cm
lb-in	1	$8.333 \times 10^{-2}$	16	0.113	1.152	$1.152 \times 10^{-2}$	$1.152 \times 10^3$	$1.129 \times 10^6$
lb-ft	12	1	192	1.355	13.825	0.138	$1.382 \times 10^4$	$1.355 \times 10^7$
oz-in	$6.25 \times 10^{-2}$	$5.208 \times 10^{-3}$	1	$7.061 \times 10^{-3}$	$7.200 \times 10^{-2}$	$7.200 \times 10^{-4}$	72.007	$7.061 \times 10^4$
N-m	8.850	0.737	141.612	1	10.197	0.102	$1.019 \times 10^4$	$1 \times 10^7$
kg-cm	0.8679	$7.233 \times 10^{-2}$	13.877	$9.806 \times 10^{-2}$	1	$10^{-2}$	1000	$9.806 \times 10^5$
kg-m	86.796	7.233	$1.388 \times 10^3$	9.806	100	1	$1 \times 10^5$	$9.806 \times 10^7$
gm-cm	$8.679 \times 10^{-4}$	$7.233 \times 10^{-5}$	$1.388 \times 10^{-2}$	$9.806 \times 10^{-5}$	$1 \times 10^{-3}$	$1 \times 10^{-5}$	1	980.665
dyne-cm	$8.850 \times 10^{-7}$	$7.375 \times 10^{-8}$	$1.416 \times 10^{-5}$	$10^{-7}$	$1.0197 \times 10^{-6}$	$1.019 \times 10^{-8}$	$1.019 \times 10^{-3}$	1

#### Length (to convert from A to B, multiply by entry in table)

A \ B	inches	feet	cm	yd	mm	m
inches	1	0.0833	2.54	0.028	25.4	0.0254
feet	12	1	30.48	0.333	304.8	0.3048
cm	0.3937	0.03281	1	$1.09 \times 10^{-2}$	10	0.01
yd	36	3	91.44	1	914.4	0.914
mm	0.03937	0.00328	0.1	$1.09 \times 10^{-3}$	1	0.001
m	39.37	3.281	100	1.09	1000	1

#### Force (to convert from A to B, multiply by entry in table)

A \ B	lb	oz	gm	dyne	N
lb	1	16	453.6	$4.448 \times 10^5$	4.4482
oz	0.0625	1	28.35	$2.780 \times 10^4$	0.27801
gm	$2.205 \times 10^{-3}$	0.03527	1	$1.02 \times 10^{-3}$	N.A.
dyne	$2.248 \times 10^{-6}$	$3.59 \times 10^{-5}$	980.7	1	0.00001
N	0.22481	3.5967	N.A.	100000	1

#### Mass (to convert from A to B, multiply by entry in table)

A \ B	lb	oz	gm	kg	slug
lb	1	16	453.6	0.4536	0.0311
oz	$6.25 \times 10^{-2}$	1	28.35	0.02835	$1.93 \times 10^{-3}$
gm	$2.205 \times 10^{-3}$	$3.527 \times 10^{-2}$	1	$10^{-3}$	$6.852 \times 10^{-5}$
kg	2.205	35.27	$10^3$	1	$6.852 \times 10^{-2}$
slug	32.17	514.8	$1.459 \times 10^4$	14.59	1

#### Rotation (to convert from A to B, multiply by entry in table)

A \ B	r/min	rad/s	degrees/s
r/min	1	0.105	6.0
rad/s	9.55	1	57.30
degrees/s	0.167	$1.745 \times 10^{-2}$	1

#### Power (to convert from A to B, multiply by entry in table)

A \ B	hp	Watts
hp (English)	1	745.7
(lb-in) (deg./s)	$2.645 \times 10^{-6}$	$1.972 \times 10^{-3}$
(lb-in) (r/min)	$1.587 \times 10^{-5}$	$1.183 \times 10^{-2}$
(lb-ft) (deg./s)	$3.173 \times 10^{-5}$	$2.366 \times 10^{-2}$
(lb-ft) (r/min)	$1.904 \times 10^{-4}$	0.1420
Watts	$1.341 \times 10^{-3}$	1

## Conversion tables

## Temperature Conversion

°F	°C	°C	°F
0	-17.8	-10	14
32	0	0	32
50	10	10	50
70	21.1	20	68
90	32.2	30	86
98.4	37	37	98.4
212	100	100	212
subtract 32 and multiply by $\frac{5}{9}$		multiply by $\frac{9}{5}$ and add 32	

## Mechanism Efficiencies

Acme-screw with brass nut	~0.35–0.65
Acme-screw with plastic nut	~0.50–0.85
Ball-screw	~0.85–0.95
Chain and sprocket	~0.95–0.98
Preloaded ball-screw	~0.75–0.85
Spur or bevel-gears	~0.90
Timing belts	~0.96–0.98
Worm gears	~0.45–0.85
Helical gear (1 reduction)	~0.92

## Friction Coefficients

Materials	$\mu$
Steel on steel (greased)	~0.15
Plastic on steel	~0.15–0.25
Copper on steel	~0.30
Brass on steel	~0.35
Aluminum on steel	~0.45
Steel on steel	~0.58
Mechanism	$\mu$
Ball bushings	<0.001
Linear bearings	<0.001
Dove-tail slides	~0.2++
Gibb ways	~0.5++

## Material Densities

Material	lb-in <sup>3</sup>	gm-cm <sup>3</sup>
Aluminum	0.096	2.66
Brass	0.299	8.30
Bronze	0.295	8.17
Copper	0.322	8.91
Hard wood	0.029	0.80
Soft wood	0.018	0.48
Plastic	0.040	1.11
Glass	0.079–0.090	2.2–2.5
Titanium	0.163	4.51
Paper	0.025–0.043	0.7–1.2
Polyvinyl chloride	0.047–0.050	1.3–1.4
Rubber	0.033–0.036	0.92–0.99
Silicone rubber, without filler	0.043	1.2
Cast iron, gray	0.274	7.6
Steel	0.280	7.75

Wire Gauges<sup>1)</sup>

Cross-section mm <sup>2</sup>	Standard Wire Gauge (SWG)	American Wire Gauge (AWG)
0.2	25	24
0.3	23	22
0.5	21	20
0.75	20	19
1.0	19	18
1.5	17	16
2.5	15	13
4	13	11
6	12	9
10	9	7
16	7	6
25	5	3
35	3	2
50	0	1/0
70	000	2/0
95	00000	3/0
120	0000000	4/0
150	–	6/0
185	–	7/0

<sup>1)</sup> The table shows approximate SWG/AWG sizes nearest to standard metric sizes; the cross-sections do not match exactly.

## Appendix

### Notes



## 1. General Provisions

By using this catalog you can purchase hard- and software products as well as services (together hereinafter referred to as "products") described therein from Siemens Aktiengesellschaft subject to the following Terms and Conditions of Sale and Delivery (hereinafter referred to as "T&C"). Note, for products purchased from any Siemens entity having a registered office outside of Germany, the respective terms and conditions of sale and delivery of the respective Siemens entity apply exclusively. The following T&C apply exclusively for orders placed with Siemens Aktiengesellschaft, Germany.

### 1.1 For customers with a seat or registered office in European Union

For customers with a seat or registered office in European Union, the following terms and conditions apply subordinate to T&C:

- for products, which include specific terms and conditions in the text of the product description, these specific terms and conditions shall apply and subordinate thereto,,
- for stand-alone software products and software products forming a part of a product or project, the "General Conditions for Software Products for Infrastructure & Industry Business (German law)"<sup>1)</sup> and/or
- for consulting services the "Allgemeine Geschäftsbedingungen für Beratungsleistungen für Infrastructure & Industry Geschäft (Deutsches Recht)"<sup>1)</sup> (available only in German) and/or
- for other services, the „Supplementary Terms and Conditions for Services for Infrastructure & Industry Business (German Law) ("BL")"<sup>1)</sup> and/or
- for other products the "General Conditions for the Supply of Products and Services of the Electrical and Electronics Industry"<sup>1)</sup>.  
In case such products should contain Open Source Software, the conditions of which shall prevail over the "General Conditions for the Supply of Products and Services of the Electrical and Electronics Industry"<sup>1)</sup>, the Product will be given a note as to which special conditions apply to this open source software. This shall apply mutatis mutandis for notices referring to other third-party software components.

### 1.2 For customers with a seat or registered office outside European Union

For customers with a seat or registered office outside European Union, the following terms and conditions apply subordinate to T&C:

- for products, which include specific terms and conditions in the description text, these specific terms and conditions shall apply and subordinate thereto,
- for consulting services the "Standard Terms and Conditions for Consulting Services for Infrastructure & Industry Business (Swiss Law)"<sup>1)</sup> and/or
- for other services the "International Terms & Conditions for Services"<sup>1)</sup> supplemented by "Software Licensing Conditions"<sup>1)</sup> and/or
- for other products the "International Terms & Conditions for Products"<sup>1)</sup> supplemented by "Software Licensing Conditions"<sup>1)</sup>

### 1.3 For customers with master or framework agreement

To the extent products offered are covered by an existing master or framework agreement, the terms and conditions of that agreement shall apply instead of T&C.

## 2. Prices

The prices are in € (Euro) ex point of delivery, exclusive of packaging.

The sales tax (value added tax) is not included in the prices. It shall be charged separately at the respective rate according to the applicable statutory legal regulations.

Prices are subject to change without prior notice. We will charge the prices valid at the time of delivery.

To compensate for variations in the price of raw materials (e.g. silver, copper, aluminum, lead, gold, dysprosium and neodym), surcharges are calculated on a daily basis using the so-called metal factor for products containing these raw materials.

A surcharge for the respective raw material is calculated as a supplement to the price of a product if the basic official price of the raw material in question is exceeded.

The metal factor of a product indicates the basic official price (for those raw materials concerned) as of which the surcharges on the price of the product are applied, and with what method of calculation. The metal factor, provided it is relevant, can be found in the respective product description.

An exact explanation of the metal factor can be downloaded at: [https://mall.industry.siemens.com/legal/ww/en/terms\\_of\\_trade\\_en.pdf](https://mall.industry.siemens.com/legal/ww/en/terms_of_trade_en.pdf)

To calculate the surcharge (except in the cases of copper, dysprosium and neodym), the official price from the day prior to that on which the order was received or the release order was effected is used.

To calculate the surcharge applicable to copper, the official price from two days prior to that on which the order was received or the release order was effected is used.

To calculate the surcharge applicable to dysprosium and neodym ("rare earths"), the corresponding three-month basic average price in the quarter prior to that in which the order was received or the release order was effected is used with a one-month buffer (details on the calculation can be found in the explanation of the metal factor).

## 3. Additional Terms and Conditions

The dimensions are in mm. In Germany, according to the German law on units in measuring technology, data in inches apply only to devices for export.

Illustrations are not binding.

Insofar as there are no remarks on the individual pages of this catalog – especially with regard to data, dimensions and weights given – these are subject to change without prior notice.

<sup>1)</sup> The text of the Terms and Conditions of Siemens AG can be downloaded at [https://mall.industry.siemens.com/legal/ww/en/terms\\_of\\_trade\\_en.pdf](https://mall.industry.siemens.com/legal/ww/en/terms_of_trade_en.pdf)

## Appendix

### Conditions of sale and delivery

#### 4. Export Control and Sanctions Compliance

##### 4.1 General

Customer shall comply with all applicable sanctions, embargoes and (re-)export control laws and regulations, and, in any event, with those of the European Union, the United States of America and any locally applicable jurisdiction (collectively "Export Regulations").

##### 4.2 Checks for Products

Prior to any transaction by customer concerning products (including hardware, documentation and technology) delivered by Siemens, or products (including maintenance and technical support) performed by Siemens with a third party, customer shall check and certify by appropriate measures that

- (i) the customer's use, transfer, or distribution of such products, the brokering of contracts or the provision of other economic resources in connection with products will not be in violation of any Export Regulations, also taking into account any prohibitions to circumvent these (e.g., by undue diversion)
- (ii) the products are not intended or provided for prohibited or unauthorized non-civilian purposes (e.g. armaments, nuclear technology, weapons, or any other usage in the field of defense and military);
- (iii) customer has screened all direct and indirect parties involved in the receipt, use, transfer, or distribution of the products against all applicable restricted party lists of the Export Regulations concerning trading with entities, persons and organizations listed therein and
- (iv) products within the scope of items-related restrictions, as specified in the respective annexes to the Export Regulations, will not, unless permitted by the Export Regulations, be
  - (a) exported, directly or indirectly (e.g., via Eurasian Economic Union (EAEU) countries), to Russia or Belarus, or
  - (b) resold to any third party business partner that does not take a prior commitment not to export such products to Russia or Belarus.

##### 4.3 Non-Acceptable Use of Software and Cloud Services

Customer shall not, unless permitted by the Export Regulations or respective governmental licenses or approvals,

- (i) download, install, access or use the products from or in any location prohibited by or subject to comprehensive sanctions or subject or to license requirements according to the Export Regulations;
  - (ii) grant access to, transfer, (re-)export (including any "deemed (re-)exports"), or otherwise make available the products to any entity, person, or organization identified on a restricted party list of the Export Regulations;
  - (iii) use the products for any purpose prohibited by the Export Regulations (e.g. use in connection with armaments, nuclear technology or weapons);
  - (iv) upload to a products platform any customer content unless it is non-controlled (e.g. in the EU: AL = N; in the U.S.: ECCN = N or EAR99);
  - (v) facilitate any of the afore mentioned activities by any user.
- Customer shall provide all users with all information necessary to ensure compliance with the Export Regulations.

##### 4.4 Semiconductor Development

Customer will not, without advance written authorization from Siemens, use offerings for the development or production of integrated circuits at any semiconductor fabrication facility located in China meeting the criteria specified in the U.S. Export Administration Regulations, 15 C.F.R. 744.23.

##### 4.5 Information

Upon request by Siemens, customer shall promptly provide Siemens with all information pertaining to users, the intended use and the location of use or the final destination (in the case of hardware, documentation and technology) of the products. Customer will notify Siemens prior to customer disclosing any information to Siemens that is defense-related or requires controlled or special data handling pursuant to applicable government regulations, and will use the disclosure tools and methods specified by Siemens.

##### 4.6 Reservation

Siemens shall not be obligated to fulfill this agreement if such fulfillment is prevented by any impediments arising out of national or international foreign trade or customs requirements or any embargoes or other sanctions. Customer acknowledges that Siemens may be obliged under the Export Regulations to limit or suspend access by customer and/or users to products.

#### 5. Miscellaneous

Errors excepted and subject to change without prior notice.

# Selection and ordering at Siemens SiePortal – Ordering products and downloading catalogs

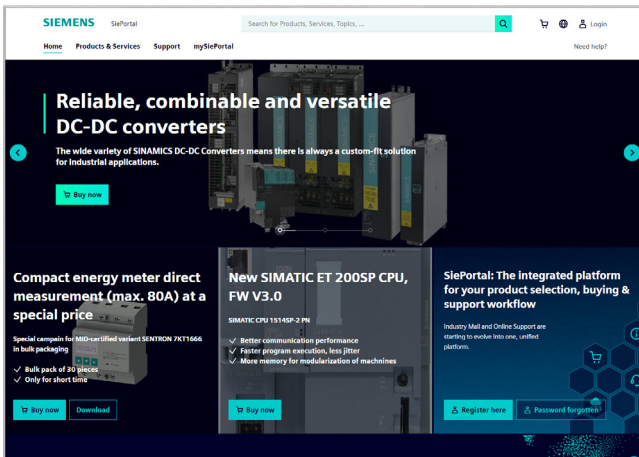

## Easy product selection and ordering with SiePortal

### SiePortal > Products & Services

The internet ordering platform of Siemens AG is located in SiePortal. It provides you with online access to a comprehensive product spectrum that is presented in an informative, well-organized way.

Powerful search functions help you select the required products, while configurators enable you to configure complex product and system components quickly and easily. CAX data are also available for you to use.

Data transfer allows the entire procedure, from selection through ordering to tracking and tracing, to be carried out online. Availability checks, individual customer discounting, and quotation preparation are also possible.

<https://sieportal.siemens.com>

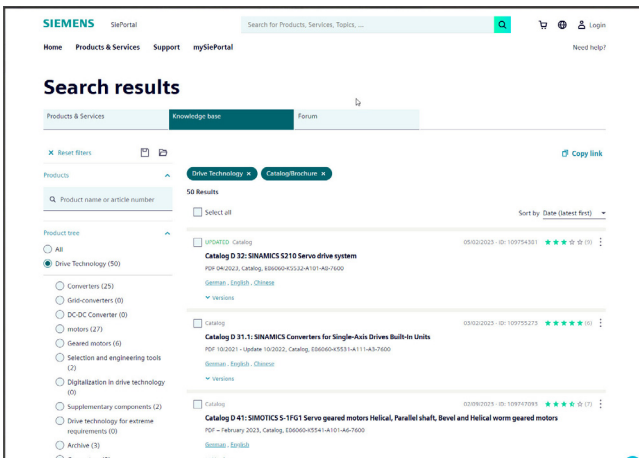

## Downloading catalogs

### SiePortal > Support > Knowledge base

You can download catalogs and brochures in PDF format from Siemens Industry Online Support without having to register.

The filter box makes it possible to perform targeted searches.

<https://sieportal.siemens.com>

## Cybersecurity information

Siemens provides products and solutions with industrial cybersecurity functions that support the secure operation of plants, systems, machines and networks.

In order to protect plants, systems, machines and networks against cyber threats, it is necessary to implement – and continuously maintain – a holistic, state-of-the-art industrial cybersecurity concept. Siemens' products and solutions constitute one element of such a concept.

Customers are responsible for preventing unauthorized access to their plants, systems, machines and networks. Such systems, machines and components should only be connected to an enterprise network or the internet if and to the extent such a connection is necessary and only when appropriate security measures (e.g. firewalls and/or network segmentation) are in place.

For additional information on industrial cybersecurity measures that may be implemented, please visit [www.siemens.com/cybersecurity-industry](http://www.siemens.com/cybersecurity-industry)

Siemens' products and solutions undergo continuous development to make them more secure. Siemens strongly recommends that product updates are applied as soon as they are available and that the latest product versions are used. Use of product versions that are no longer supported, and failure to apply the latest updates may increase customer's exposure to cyber threats.

To stay informed about product updates, subscribe to the Siemens Industrial Cybersecurity RSS Feed under [www.siemens.com/cert](http://www.siemens.com/cert)

## Get more information

SINAMICS G220 built-in and wall-mounted units:

[www.siemens.com/sinamics-g220](http://www.siemens.com/sinamics-g220)

SIMOTICS motors for industry:

[www.siemens.com/simotics](http://www.siemens.com/simotics)

Motion Control Systems and Solutions for production machine and machine tool equipment:

[www.siemens.com/motioncontrol](http://www.siemens.com/motioncontrol)

Local partners worldwide:

[www.siemens.com/automation-contact](http://www.siemens.com/automation-contact)

Published by  
Siemens AG

Digital Industries  
Motion Control  
Postfach 31 80  
91050 Erlangen, Germany

For the U.S. published by  
Siemens Industry Inc.

100 Technology Drive  
Alpharetta, GA 30005  
United States

PDF (Article No. E86060-K5536-A111-A4-7600)  
V6.MKKATA.GMC.600  
KG 0125 128 En  
Produced in Germany  
© Siemens 2025



Subject to changes and errors. The information given in this document only contains general descriptions and/or performance features which may not always specifically reflect those described, or which may undergo modification in the course of further development of the products. The requested performance features are binding only when they are expressly agreed upon in the concluded contract.

All product designations may be trademarks or product names of Siemens AG or other companies whose use by third parties for their own purposes could violate the rights of the owners.